







Assembly code	Assembly description	Assembly image
ASM1744C/0.D04	Cooking chamber	
ASM1770C/0.D02	External cover	
ASM3006B/0.D03	Door	
ASM3334A/0.D02	Electrical system	



ASM1744C/0.D04 - Cooking chamber - FRONT

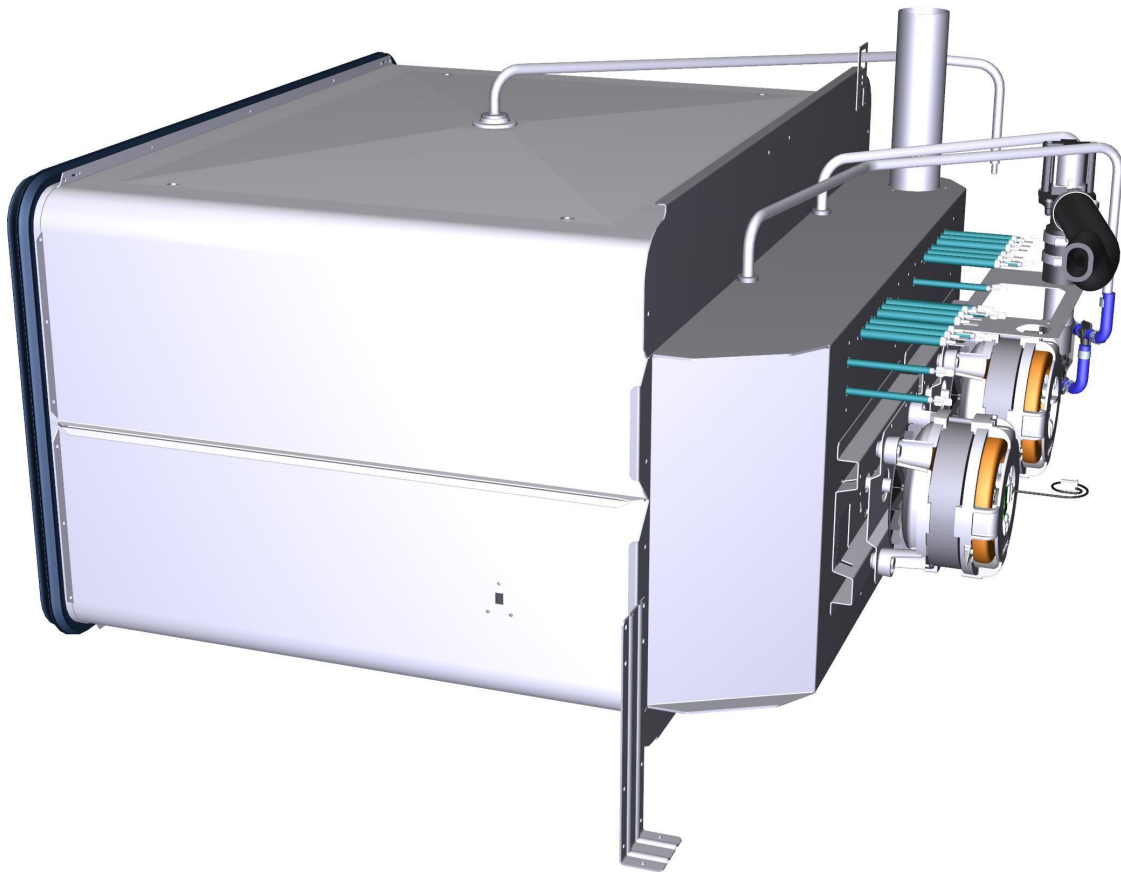





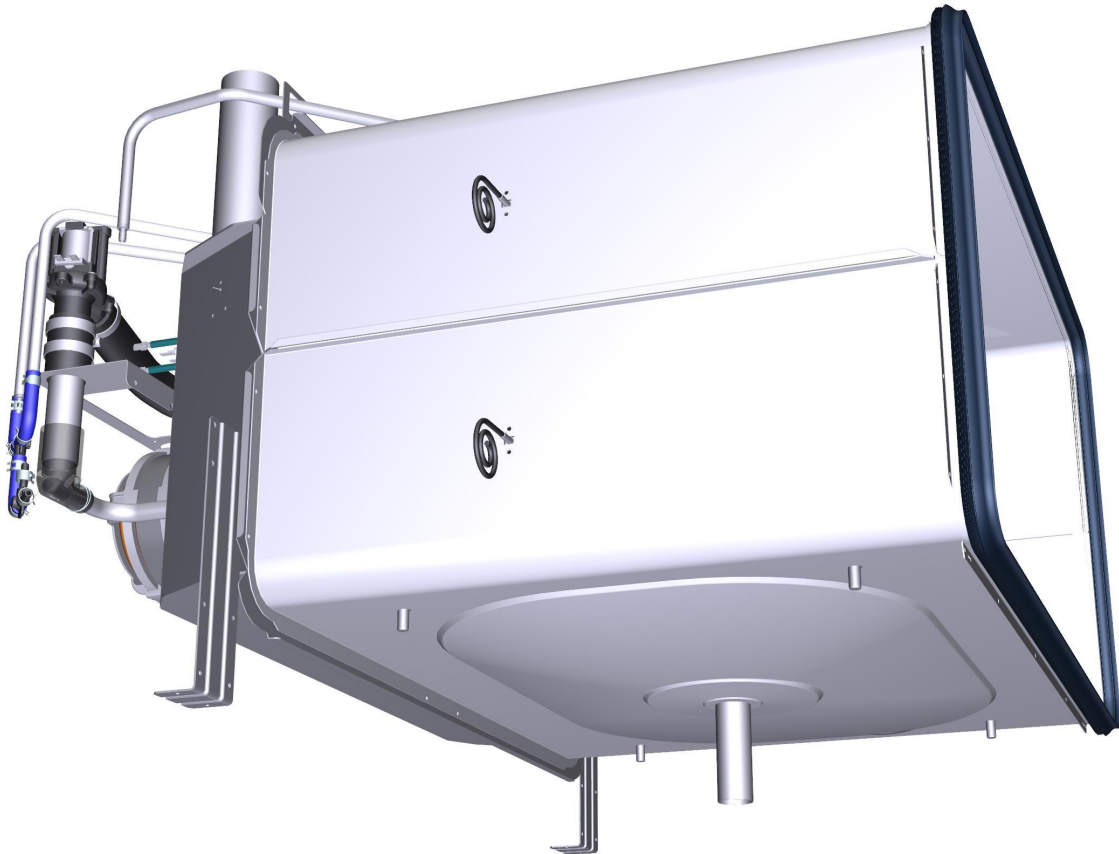



ASM1744C/0.D04 - Cooking chamber - REAR

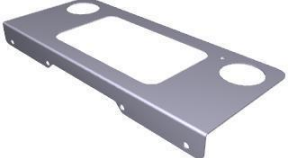



COMPONENT			SPARE PART																										
Code	Description	Image	Code	Description	Kit components																								
0G1599A	XEBC-04EU-E FAN GUARD DIVIDING PLATE		0G1599A0	XEBC-04EU-E FAN GUARD DIVIDING PLATE																									
0H2551A	XBC/XVC ST.STEEL DRAIN COVER		K0H2551A	DRAIN COVER KIT	<table border="1"> <thead> <tr> <th>Code</th> <th>Description</th> <th>Qty</th> <th>UOM</th> </tr> </thead> <tbody> <tr> <td>0H2551A0</td> <td>XBC/XVC ST.STEEL DRAIN COVER</td> <td>1.000</td> <td>PC</td> </tr> </tbody> </table>	Code	Description	Qty	UOM	0H2551A0	XBC/XVC ST.STEEL DRAIN COVER	1.000	PC																
Code	Description	Qty	UOM																										
0H2551A0	XBC/XVC ST.STEEL DRAIN COVER	1.000	PC																										
0H2730A	ZINC PLATED MUFFLE SUPPORT BRACKET		0H2730A1	ZINC PLATED MUFFLE SUPPORT BRACKET																									
0H7449A	MM GAS VENTURI COLLECT PIPE FIXING PLATE		0H7449A0	MM GAS VENTURI COLLECT PIPE FIXING PLATE																									
PE1710B	MOTOR REVOLUTION AND DIRECTION SENSO		KPE1710B	MOTOR REVOLUTIONS SENSOR KIT	<table border="1"> <thead> <tr> <th>Code</th> <th>Description</th> <th>Qty</th> <th>UOM</th> </tr> </thead> <tbody> <tr> <td>CE1119A0</td> <td>AMP MODU2 4P 4XAWG22 L1500 RAST 4P CABLE</td> <td>1.000</td> <td>PC</td> </tr> <tr> <td>PE1040A0</td> <td>RAST MOTOR SENSOR</td> <td>1.000</td> <td>PC</td> </tr> <tr> <td>VE1550A0</td> <td>5X3 MM NEODYMIUM MAGNET</td> <td>1.000</td> <td>PC</td> </tr> <tr> <td>VI1966A0</td> <td>M4X14 FLATHEAD SCREW</td> <td>1.000</td> <td>PC</td> </tr> <tr> <td>VM1635A0</td> <td>MAGNET HOLDING DIS</td> <td>1.000</td> <td>PC</td> </tr> </tbody> </table>	Code	Description	Qty	UOM	CE1119A0	AMP MODU2 4P 4XAWG22 L1500 RAST 4P CABLE	1.000	PC	PE1040A0	RAST MOTOR SENSOR	1.000	PC	VE1550A0	5X3 MM NEODYMIUM MAGNET	1.000	PC	VI1966A0	M4X14 FLATHEAD SCREW	1.000	PC	VM1635A0	MAGNET HOLDING DIS	1.000	PC
Code	Description	Qty	UOM																										
CE1119A0	AMP MODU2 4P 4XAWG22 L1500 RAST 4P CABLE	1.000	PC																										
PE1040A0	RAST MOTOR SENSOR	1.000	PC																										
VE1550A0	5X3 MM NEODYMIUM MAGNET	1.000	PC																										
VI1966A0	M4X14 FLATHEAD SCREW	1.000	PC																										
VM1635A0	MAGNET HOLDING DIS	1.000	PC																										

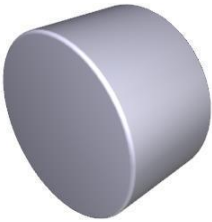
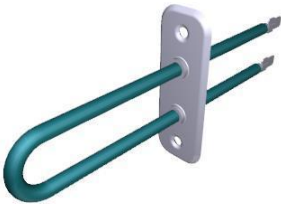



COMPONENT			SPARE PART																										
Code	Description	Image	Code	Description	Kit components																								
VE1550A	5X3 MM NEODYMIUM MAGNET		KPE1710B	MOTOR REVOLUTIONS SENSOR KIT	<table border="1"> <thead> <tr> <th>Code</th> <th>Description</th> <th>Qty</th> <th>UOM</th> </tr> </thead> <tbody> <tr> <td>CE1119A0</td> <td>AMPMODU2 4P 4XAWG22 L1500 RAST 4P CABLE</td> <td>1.000</td> <td>PC</td> </tr> <tr> <td>PE1040A0</td> <td>RAST MOTOR SENSOR</td> <td>1.000</td> <td>PC</td> </tr> <tr> <td>VE1550A0</td> <td>5X3 MM NEODYMIUM MAGNET</td> <td>1.000</td> <td>PC</td> </tr> <tr> <td>VI1966A0</td> <td>M4X14 FLATHEAD SCREW</td> <td>1.000</td> <td>PC</td> </tr> <tr> <td>VM1635A0</td> <td>MAGNET HOLDING DIS</td> <td>1.000</td> <td>PC</td> </tr> </tbody> </table>	Code	Description	Qty	UOM	CE1119A0	AMPMODU2 4P 4XAWG22 L1500 RAST 4P CABLE	1.000	PC	PE1040A0	RAST MOTOR SENSOR	1.000	PC	VE1550A0	5X3 MM NEODYMIUM MAGNET	1.000	PC	VI1966A0	M4X14 FLATHEAD SCREW	1.000	PC	VM1635A0	MAGNET HOLDING DIS	1.000	PC
Code	Description	Qty	UOM																										
CE1119A0	AMPMODU2 4P 4XAWG22 L1500 RAST 4P CABLE	1.000	PC																										
PE1040A0	RAST MOTOR SENSOR	1.000	PC																										
VE1550A0	5X3 MM NEODYMIUM MAGNET	1.000	PC																										
VI1966A0	M4X14 FLATHEAD SCREW	1.000	PC																										
VM1635A0	MAGNET HOLDING DIS	1.000	PC																										
GN1672A	BREAKING ELEMENT GASKET		KGN1672A	71x19 HEATING ELEMENT GASKET 5 PCS KIT	<table border="1"> <thead> <tr> <th>Code</th> <th>Description</th> <th>Qty</th> <th>UOM</th> </tr> </thead> <tbody> <tr> <td>GN1672A1</td> <td>BREAKING ELEMENT GASKET</td> <td>5.000</td> <td>PC</td> </tr> </tbody> </table>	Code	Description	Qty	UOM	GN1672A1	BREAKING ELEMENT GASKET	5.000	PC																
Code	Description	Qty	UOM																										
GN1672A1	BREAKING ELEMENT GASKET	5.000	PC																										
RS1215B	1 TURN 147W 105V FLAT ELEMENT		KRS1034A	MM 147W MOTOR BRAKING ELEMENT KIT	<table border="1"> <thead> <tr> <th>Code</th> <th>Description</th> <th>Qty</th> <th>UOM</th> </tr> </thead> <tbody> <tr> <td>GN1672A1</td> <td>BREAKING ELEMENT GASKET</td> <td>1.000</td> <td>PC</td> </tr> <tr> <td>RS1034A0</td> <td>1 TURN 147W 105V FLAT ELEMENT</td> <td>1.000</td> <td>PC</td> </tr> <tr> <td>SL1045A0</td> <td>S57 BLACK SILICONE - 80ml CARTRIDGE</td> <td>1.000</td> <td>PC</td> </tr> <tr> <td>VI1220A1</td> <td>4,2x12 TCB SELF-TAPPIN G SCREW</td> <td>2.000</td> <td>PC</td> </tr> </tbody> </table>	Code	Description	Qty	UOM	GN1672A1	BREAKING ELEMENT GASKET	1.000	PC	RS1034A0	1 TURN 147W 105V FLAT ELEMENT	1.000	PC	SL1045A0	S57 BLACK SILICONE - 80ml CARTRIDGE	1.000	PC	VI1220A1	4,2x12 TCB SELF-TAPPIN G SCREW	2.000	PC				
Code	Description	Qty	UOM																										
GN1672A1	BREAKING ELEMENT GASKET	1.000	PC																										
RS1034A0	1 TURN 147W 105V FLAT ELEMENT	1.000	PC																										
SL1045A0	S57 BLACK SILICONE - 80ml CARTRIDGE	1.000	PC																										
VI1220A1	4,2x12 TCB SELF-TAPPIN G SCREW	2.000	PC																										
GN1285A	NTC TEMPERATURE PROBE SEALING		KTR1106B	MIND.Maps L2000 CHAMBER TEMP. PROBE KIT	<table border="1"> <thead> <tr> <th>Code</th> <th>Description</th> <th>Qty</th> <th>UOM</th> </tr> </thead> <tbody> <tr> <td>GN1285A0</td> <td>NTC TEMPERATUR E PROBE SEALING</td> <td>1.000</td> <td>PC</td> </tr> <tr> <td>SL1045A0</td> <td>S57 BLACK SILICONE - 80ml CARTRIDGE</td> <td>1.000</td> <td>PC</td> </tr> <tr> <td>TR1106B0</td> <td>PT100 L=2000 TEMPERATUR E PROBE</td> <td>1.000</td> <td>PC</td> </tr> </tbody> </table>	Code	Description	Qty	UOM	GN1285A0	NTC TEMPERATUR E PROBE SEALING	1.000	PC	SL1045A0	S57 BLACK SILICONE - 80ml CARTRIDGE	1.000	PC	TR1106B0	PT100 L=2000 TEMPERATUR E PROBE	1.000	PC								
Code	Description	Qty	UOM																										
GN1285A0	NTC TEMPERATUR E PROBE SEALING	1.000	PC																										
SL1045A0	S57 BLACK SILICONE - 80ml CARTRIDGE	1.000	PC																										
TR1106B0	PT100 L=2000 TEMPERATUR E PROBE	1.000	PC																										







COMPONENT			SPARE PART																											
Code	Description	Image	Code	Description	Kit components																									
GN1285A	NTC TEMPERATURE PROBE SEALING		KTR1106B	MIND.Maps L2000 CHAMBER TEMP. PROBE KIT	<table border="1"> <thead> <tr> <th>Code</th> <th>Description</th> <th>Qty</th> <th>UOM</th> </tr> </thead> <tbody> <tr> <td>VI1220A1</td> <td>4,2x12 TCB SELF-TAPPIN G SCREW</td> <td>2.000</td> <td>PC</td> </tr> <tr> <td>VM1464A1</td> <td>CT BT TEMPERATUR E PROBE COVER</td> <td>1.000</td> <td>PC</td> </tr> <tr> <td>VM1465A1</td> <td>CT BT TEMPERATUR E PROBE COVER</td> <td>1.000</td> <td>PC</td> </tr> </tbody> </table>	Code	Description	Qty	UOM	VI1220A1	4,2x12 TCB SELF-TAPPIN G SCREW	2.000	PC	VM1464A1	CT BT TEMPERATUR E PROBE COVER	1.000	PC	VM1465A1	CT BT TEMPERATUR E PROBE COVER	1.000	PC									
			Code	Description	Qty	UOM																								
			VI1220A1	4,2x12 TCB SELF-TAPPIN G SCREW	2.000	PC																								
VM1464A1	CT BT TEMPERATUR E PROBE COVER	1.000	PC																											
VM1465A1	CT BT TEMPERATUR E PROBE COVER	1.000	PC																											
KTR1106A	5-5E S. L2000 CHAMBER TEMP. PROBE KIT	<table border="1"> <thead> <tr> <th>Code</th> <th>Description</th> <th>Qty</th> <th>UOM</th> </tr> </thead> <tbody> <tr> <td>GN1285A0</td> <td>NTC TEMPERATUR E PROBE SEALING</td> <td>1.000</td> <td>PC</td> </tr> <tr> <td>SL1045A0</td> <td>S57 BLACK SILICONE - 80ml CARTRIDGE</td> <td>1.000</td> <td>PC</td> </tr> <tr> <td>TR1106A3</td> <td>PT100 L-2000 TEMPERATUR E PROBE</td> <td>1.000</td> <td>PC</td> </tr> <tr> <td>VI1220A1</td> <td>4,2x12 TCB SELF-TAPPIN G SCREW</td> <td>2.000</td> <td>PC</td> </tr> <tr> <td>VM1465A1</td> <td>CT BT TEMPERATUR E PROBE COVER</td> <td>1.000</td> <td>PC</td> </tr> </tbody> </table>	Code	Description	Qty	UOM	GN1285A0	NTC TEMPERATUR E PROBE SEALING	1.000	PC	SL1045A0	S57 BLACK SILICONE - 80ml CARTRIDGE	1.000	PC	TR1106A3	PT100 L-2000 TEMPERATUR E PROBE	1.000	PC	VI1220A1	4,2x12 TCB SELF-TAPPIN G SCREW	2.000	PC	VM1465A1	CT BT TEMPERATUR E PROBE COVER	1.000	PC				
Code	Description	Qty	UOM																											
GN1285A0	NTC TEMPERATUR E PROBE SEALING	1.000	PC																											
SL1045A0	S57 BLACK SILICONE - 80ml CARTRIDGE	1.000	PC																											
TR1106A3	PT100 L-2000 TEMPERATUR E PROBE	1.000	PC																											
VI1220A1	4,2x12 TCB SELF-TAPPIN G SCREW	2.000	PC																											
VM1465A1	CT BT TEMPERATUR E PROBE COVER	1.000	PC																											
KTR1105A	PT100 L1000 TEMPERATURE PROBE KIT	<table border="1"> <thead> <tr> <th>Code</th> <th>Description</th> <th>Qty</th> <th>UOM</th> </tr> </thead> <tbody> <tr> <td>GN1120A1</td> <td>NTC TEMPERATUR E PROBE SEAL</td> <td>1.000</td> <td>PC</td> </tr> <tr> <td>GN1285A0</td> <td>NTC TEMPERATUR E PROBE SEALING</td> <td>1.000</td> <td>PC</td> </tr> <tr> <td>SL1045A0</td> <td>S57 BLACK SILICONE - 80ml CARTRIDGE</td> <td>1.000</td> <td>PC</td> </tr> <tr> <td>TR1105A4</td> <td>L1000 PT100 TEMPERATUR E PROBE</td> <td>1.000</td> <td>PC</td> </tr> <tr> <td>VI1220A1</td> <td>4,2x12 TCB SELF-TAPPIN G SCREW</td> <td>2.000</td> <td>PC</td> </tr> <tr> <td>VM1464A1</td> <td>CT BT TEMPERATUR E PROBE COVER</td> <td>1.000</td> <td>PC</td> </tr> </tbody> </table>	Code	Description	Qty	UOM	GN1120A1	NTC TEMPERATUR E PROBE SEAL	1.000	PC	GN1285A0	NTC TEMPERATUR E PROBE SEALING	1.000	PC	SL1045A0	S57 BLACK SILICONE - 80ml CARTRIDGE	1.000	PC	TR1105A4	L1000 PT100 TEMPERATUR E PROBE	1.000	PC	VI1220A1	4,2x12 TCB SELF-TAPPIN G SCREW	2.000	PC	VM1464A1	CT BT TEMPERATUR E PROBE COVER	1.000	PC
Code	Description	Qty	UOM																											
GN1120A1	NTC TEMPERATUR E PROBE SEAL	1.000	PC																											
GN1285A0	NTC TEMPERATUR E PROBE SEALING	1.000	PC																											
SL1045A0	S57 BLACK SILICONE - 80ml CARTRIDGE	1.000	PC																											
TR1105A4	L1000 PT100 TEMPERATUR E PROBE	1.000	PC																											
VI1220A1	4,2x12 TCB SELF-TAPPIN G SCREW	2.000	PC																											
VM1464A1	CT BT TEMPERATUR E PROBE COVER	1.000	PC																											

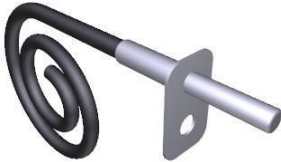





COMPONENT			SPARE PART																											
Code	Description	Image	Code	Description	Kit components																									
GN1285A	NTC TEMPERATURE PROBE SEALING		KTR1105A	PT100 L1000 TEMPERATURE PROBE KIT	<table border="1"> <thead> <tr> <th>Code</th> <th>Description</th> <th>Qty</th> <th>UOM</th> </tr> </thead> <tbody> <tr> <td>VM1465A1</td> <td>CT BT TEMPERATUR E PROBE COVER</td> <td>1.000</td> <td>PC</td> </tr> <tr> <td>VM2052A0</td> <td>LM CORE PROBE COVE</td> <td>1.000</td> <td>PC</td> </tr> </tbody> </table>	Code	Description	Qty	UOM	VM1465A1	CT BT TEMPERATUR E PROBE COVER	1.000	PC	VM2052A0	LM CORE PROBE COVE	1.000	PC													
			Code	Description	Qty	UOM																								
			VM1465A1	CT BT TEMPERATUR E PROBE COVER	1.000	PC																								
VM2052A0	LM CORE PROBE COVE	1.000	PC																											
KTR1096A	NTC 150 L=1500 TEMPERATURE PROBE KIT	<table border="1"> <thead> <tr> <th>Code</th> <th>Description</th> <th>Qty</th> <th>UOM</th> </tr> </thead> <tbody> <tr> <td>GN1120A1</td> <td>NTC TEMPERATUR E PROBE SEAL</td> <td>1.000</td> <td>PC</td> </tr> <tr> <td>GN1285A0</td> <td>NTC TEMPERATUR E PROBE SEALING</td> <td>2.000</td> <td>PC</td> </tr> <tr> <td>SL1045A0</td> <td>S57 BLACK SILICONE - 80ml CARTRIDGE</td> <td>1.000</td> <td>PC</td> </tr> <tr> <td>TR1096A0</td> <td>TEMPERATUR E PROBE NTC 150 L=1500</td> <td>1.000</td> <td>PC</td> </tr> <tr> <td>VI1220A1</td> <td>4,2x12 TCB SELF-TAPPIN G SCREW</td> <td>2.000</td> <td>PC</td> </tr> <tr> <td>VM1465A1</td> <td>CT BT TEMPERATUR E PROBE COVER</td> <td>1.000</td> <td>PC</td> </tr> </tbody> </table>	Code	Description	Qty	UOM	GN1120A1	NTC TEMPERATUR E PROBE SEAL	1.000	PC	GN1285A0	NTC TEMPERATUR E PROBE SEALING	2.000	PC	SL1045A0	S57 BLACK SILICONE - 80ml CARTRIDGE	1.000	PC	TR1096A0	TEMPERATUR E PROBE NTC 150 L=1500	1.000	PC	VI1220A1	4,2x12 TCB SELF-TAPPIN G SCREW	2.000	PC	VM1465A1	CT BT TEMPERATUR E PROBE COVER	1.000	PC
Code	Description	Qty	UOM																											
GN1120A1	NTC TEMPERATUR E PROBE SEAL	1.000	PC																											
GN1285A0	NTC TEMPERATUR E PROBE SEALING	2.000	PC																											
SL1045A0	S57 BLACK SILICONE - 80ml CARTRIDGE	1.000	PC																											
TR1096A0	TEMPERATUR E PROBE NTC 150 L=1500	1.000	PC																											
VI1220A1	4,2x12 TCB SELF-TAPPIN G SCREW	2.000	PC																											
VM1465A1	CT BT TEMPERATUR E PROBE COVER	1.000	PC																											
KTR1095A	NTC 150 L=1050 TEMPERATURE PROBE KIT	<table border="1"> <thead> <tr> <th>Code</th> <th>Description</th> <th>Qty</th> <th>UOM</th> </tr> </thead> <tbody> <tr> <td>GN1120A1</td> <td>NTC TEMPERATUR E PROBE SEAL</td> <td>1.000</td> <td>PC</td> </tr> <tr> <td>GN1285A0</td> <td>NTC TEMPERATUR E PROBE SEALING</td> <td>1.000</td> <td>PC</td> </tr> <tr> <td>SL1045A0</td> <td>S57 BLACK SILICONE - 80ml CARTRIDGE</td> <td>1.000</td> <td>PC</td> </tr> <tr> <td>TR1095A0</td> <td>TEMPERATUR E PROBE NTC 150 L=1050</td> <td>1.000</td> <td>PC</td> </tr> <tr> <td>VI1220A1</td> <td>4,2x12 TCB SELF-TAPPIN G SCREW</td> <td>2.000</td> <td>PC</td> </tr> <tr> <td>VM1465A1</td> <td>CT BT TEMPERATUR E PROBE COVER</td> <td>1.000</td> <td>PC</td> </tr> </tbody> </table>	Code	Description	Qty	UOM	GN1120A1	NTC TEMPERATUR E PROBE SEAL	1.000	PC	GN1285A0	NTC TEMPERATUR E PROBE SEALING	1.000	PC	SL1045A0	S57 BLACK SILICONE - 80ml CARTRIDGE	1.000	PC	TR1095A0	TEMPERATUR E PROBE NTC 150 L=1050	1.000	PC	VI1220A1	4,2x12 TCB SELF-TAPPIN G SCREW	2.000	PC	VM1465A1	CT BT TEMPERATUR E PROBE COVER	1.000	PC
Code	Description	Qty	UOM																											
GN1120A1	NTC TEMPERATUR E PROBE SEAL	1.000	PC																											
GN1285A0	NTC TEMPERATUR E PROBE SEALING	1.000	PC																											
SL1045A0	S57 BLACK SILICONE - 80ml CARTRIDGE	1.000	PC																											
TR1095A0	TEMPERATUR E PROBE NTC 150 L=1050	1.000	PC																											
VI1220A1	4,2x12 TCB SELF-TAPPIN G SCREW	2.000	PC																											
VM1465A1	CT BT TEMPERATUR E PROBE COVER	1.000	PC																											



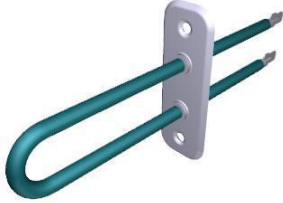

COMPONENT			SPARE PART																														
Code	Description	Image	Code	Description	Kit components																												
GN1285A	NTC TEMPERATURE PROBE SEALING		KTR1002A	PT100 L1000 UL TEMPERATURE PROBE KIT	<table border="1"> <thead> <tr> <th>Code</th> <th>Description</th> <th>Qty</th> <th>UOM</th> </tr> </thead> <tbody> <tr> <td>GN1285A0</td> <td>NTC TEMPERATUR E PROBE SEALING</td> <td>2.000</td> <td>PC</td> </tr> <tr> <td>SL1045A0</td> <td>S57 BLACK SILICONE - 80ml CARTRIDGE</td> <td>1.000</td> <td>PC</td> </tr> <tr> <td>TR1002A1</td> <td></td> <td>1.000</td> <td>PC</td> </tr> <tr> <td>VI1220A1</td> <td>4,2x12 TCB SELF-TAPPIN G SCREW</td> <td>2.000</td> <td>PC</td> </tr> <tr> <td>VM1465A1</td> <td>CT BT TEMPERATUR E PROBE COVER</td> <td>1.000</td> <td>PC</td> </tr> </tbody> </table>	Code	Description	Qty	UOM	GN1285A0	NTC TEMPERATUR E PROBE SEALING	2.000	PC	SL1045A0	S57 BLACK SILICONE - 80ml CARTRIDGE	1.000	PC	TR1002A1		1.000	PC	VI1220A1	4,2x12 TCB SELF-TAPPIN G SCREW	2.000	PC	VM1465A1	CT BT TEMPERATUR E PROBE COVER	1.000	PC				
Code	Description	Qty	UOM																														
GN1285A0	NTC TEMPERATUR E PROBE SEALING	2.000	PC																														
SL1045A0	S57 BLACK SILICONE - 80ml CARTRIDGE	1.000	PC																														
TR1002A1		1.000	PC																														
VI1220A1	4,2x12 TCB SELF-TAPPIN G SCREW	2.000	PC																														
VM1465A1	CT BT TEMPERATUR E PROBE COVER	1.000	PC																														
TR1106B	PT100 L=2000 TEMPERATURE PROBE		KTR1106B	MIND.Maps L2000 CHAMBER TEMP. PROBE KIT	<table border="1"> <thead> <tr> <th>Code</th> <th>Description</th> <th>Qty</th> <th>UOM</th> </tr> </thead> <tbody> <tr> <td>GN1285A0</td> <td>NTC TEMPERATUR E PROBE SEALING</td> <td>1.000</td> <td>PC</td> </tr> <tr> <td>SL1045A0</td> <td>S57 BLACK SILICONE - 80ml CARTRIDGE</td> <td>1.000</td> <td>PC</td> </tr> <tr> <td>TR1106B0</td> <td>PT100 L=2000 TEMPERATUR E PROBE</td> <td>1.000</td> <td>PC</td> </tr> <tr> <td>VI1220A1</td> <td>4,2x12 TCB SELF-TAPPIN G SCREW</td> <td>2.000</td> <td>PC</td> </tr> <tr> <td>VM1464A1</td> <td>CT BT TEMPERATUR E PROBE COVER</td> <td>1.000</td> <td>PC</td> </tr> <tr> <td>VM1465A1</td> <td>CT BT TEMPERATUR E PROBE COVER</td> <td>1.000</td> <td>PC</td> </tr> </tbody> </table>	Code	Description	Qty	UOM	GN1285A0	NTC TEMPERATUR E PROBE SEALING	1.000	PC	SL1045A0	S57 BLACK SILICONE - 80ml CARTRIDGE	1.000	PC	TR1106B0	PT100 L=2000 TEMPERATUR E PROBE	1.000	PC	VI1220A1	4,2x12 TCB SELF-TAPPIN G SCREW	2.000	PC	VM1464A1	CT BT TEMPERATUR E PROBE COVER	1.000	PC	VM1465A1	CT BT TEMPERATUR E PROBE COVER	1.000	PC
Code	Description	Qty	UOM																														
GN1285A0	NTC TEMPERATUR E PROBE SEALING	1.000	PC																														
SL1045A0	S57 BLACK SILICONE - 80ml CARTRIDGE	1.000	PC																														
TR1106B0	PT100 L=2000 TEMPERATUR E PROBE	1.000	PC																														
VI1220A1	4,2x12 TCB SELF-TAPPIN G SCREW	2.000	PC																														
VM1464A1	CT BT TEMPERATUR E PROBE COVER	1.000	PC																														
VM1465A1	CT BT TEMPERATUR E PROBE COVER	1.000	PC																														
VM1464A	CT BT TEMPERATURE PROBE COVER		KVM1464A	CT BT TEMPERATURE PROBE COVER KIT	<table border="1"> <thead> <tr> <th>Code</th> <th>Description</th> <th>Qty</th> <th>UOM</th> </tr> </thead> <tbody> <tr> <td>VM1464A1</td> <td>CT BT TEMPERATUR E PROBE COVER</td> <td>1.000</td> <td>PC</td> </tr> </tbody> </table>	Code	Description	Qty	UOM	VM1464A1	CT BT TEMPERATUR E PROBE COVER	1.000	PC																				
Code	Description	Qty	UOM																														
VM1464A1	CT BT TEMPERATUR E PROBE COVER	1.000	PC																														

COMPONENT			SPARE PART																										
Code	Description	Image	Code	Description	Kit components																								
RS1002A	6750W 230V D230 6 TURNS HEATING ELEMENT		KRS1002A	6750W 230V HEATING ELEMENT KIT	<table border="1"> <thead> <tr> <th>Code</th> <th>Description</th> <th>Qty</th> <th>UOM</th> </tr> </thead> <tbody> <tr> <td>GN1671A0</td> <td>141X22 G8.5 ELEMENT ARMED GASKET</td> <td>1.000</td> <td>PC</td> </tr> <tr> <td>RS1002A1</td> <td>6750W 230V D230 6 TURNS HEATING ELEMENT</td> <td>1.000</td> <td>PC</td> </tr> <tr> <td>SL1045A0</td> <td>S57 BLACK SILICONE - 80ml CARTRIDGE</td> <td>1.000</td> <td>PC</td> </tr> <tr> <td>VI1220A1</td> <td>4,2x12 TCB SELF-TAPPIN G SCREW</td> <td>5.000</td> <td>PC</td> </tr> </tbody> </table>	Code	Description	Qty	UOM	GN1671A0	141X22 G8.5 ELEMENT ARMED GASKET	1.000	PC	RS1002A1	6750W 230V D230 6 TURNS HEATING ELEMENT	1.000	PC	SL1045A0	S57 BLACK SILICONE - 80ml CARTRIDGE	1.000	PC	VI1220A1	4,2x12 TCB SELF-TAPPIN G SCREW	5.000	PC				
Code	Description	Qty	UOM																										
GN1671A0	141X22 G8.5 ELEMENT ARMED GASKET	1.000	PC																										
RS1002A1	6750W 230V D230 6 TURNS HEATING ELEMENT	1.000	PC																										
SL1045A0	S57 BLACK SILICONE - 80ml CARTRIDGE	1.000	PC																										
VI1220A1	4,2x12 TCB SELF-TAPPIN G SCREW	5.000	PC																										
0H7030A	THERMOSTAT BULB INLET COVER		K0H7030A	THERMOSTAT BULB INLET COVER KIT	<table border="1"> <thead> <tr> <th>Code</th> <th>Description</th> <th>Qty</th> <th>UOM</th> </tr> </thead> <tbody> <tr> <td>0H7030A0</td> <td>THERMOSTAT BULB INLET COVER</td> <td>1.000</td> <td>PC</td> </tr> </tbody> </table>	Code	Description	Qty	UOM	0H7030A0	THERMOSTAT BULB INLET COVER	1.000	PC																
Code	Description	Qty	UOM																										
0H7030A0	THERMOSTAT BULB INLET COVER	1.000	PC																										
GN1531A	THERMOSTAT BULB INLET SEALING		KTR1136A	318°C -0/+24 SAFETY THERMOSTAT KIT	<table border="1"> <thead> <tr> <th>Code</th> <th>Description</th> <th>Qty</th> <th>UOM</th> </tr> </thead> <tbody> <tr> <td>0H7030A0</td> <td>THERMOSTAT BULB INLET COVER</td> <td>1.000</td> <td>PC</td> </tr> <tr> <td>GN1531A0</td> <td>THERMOSTAT BULB INLET SEALING</td> <td>1.000</td> <td>PC</td> </tr> <tr> <td>SL1045A0</td> <td>S57 BLACK SILICONE - 80ml CARTRIDGE</td> <td>1.000</td> <td>PC</td> </tr> <tr> <td>TR1136A0</td> <td>318°C -0/+24 1 POLE SAFETY THERMOSTAT</td> <td>1.000</td> <td>PC</td> </tr> <tr> <td>VI1220A1</td> <td>4,2x12 TCB SELF-TAPPIN G SCREW</td> <td>3.000</td> <td>PC</td> </tr> </tbody> </table>	Code	Description	Qty	UOM	0H7030A0	THERMOSTAT BULB INLET COVER	1.000	PC	GN1531A0	THERMOSTAT BULB INLET SEALING	1.000	PC	SL1045A0	S57 BLACK SILICONE - 80ml CARTRIDGE	1.000	PC	TR1136A0	318°C -0/+24 1 POLE SAFETY THERMOSTAT	1.000	PC	VI1220A1	4,2x12 TCB SELF-TAPPIN G SCREW	3.000	PC
Code	Description	Qty	UOM																										
0H7030A0	THERMOSTAT BULB INLET COVER	1.000	PC																										
GN1531A0	THERMOSTAT BULB INLET SEALING	1.000	PC																										
SL1045A0	S57 BLACK SILICONE - 80ml CARTRIDGE	1.000	PC																										
TR1136A0	318°C -0/+24 1 POLE SAFETY THERMOSTAT	1.000	PC																										
VI1220A1	4,2x12 TCB SELF-TAPPIN G SCREW	3.000	PC																										
GN1672A	BREAKING ELEMENT GASKET		KG1672A	71x19 HEATING ELEMENT GASKET 5 PCS KIT	<table border="1"> <thead> <tr> <th>Code</th> <th>Description</th> <th>Qty</th> <th>UOM</th> </tr> </thead> <tbody> <tr> <td>GN1672A1</td> <td>BREAKING ELEMENT GASKET</td> <td>5.000</td> <td>PC</td> </tr> </tbody> </table>	Code	Description	Qty	UOM	GN1672A1	BREAKING ELEMENT GASKET	5.000	PC																
Code	Description	Qty	UOM																										
GN1672A1	BREAKING ELEMENT GASKET	5.000	PC																										

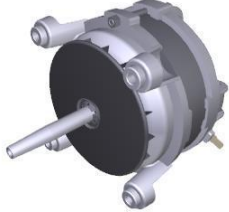

COMPONENT			SPARE PART																						
Code	Description	Image	Code	Description	Kit components																				
RS1274B	1 TURN 100W 60V FLAT ELEMENT		KRS1036A	MM GAS 100W MOTOR BRAKING ELEMENT KIT	<table border="1"> <thead> <tr> <th>Code</th> <th>Description</th> <th>Qty</th> <th>UOM</th> </tr> </thead> <tbody> <tr> <td>GN1672A1</td> <td>BREAKING ELEMENT GASKET</td> <td>1.000</td> <td>PC</td> </tr> <tr> <td>RS1036A0</td> <td></td> <td>1.000</td> <td>PC</td> </tr> <tr> <td>SL1045A0</td> <td>S57 BLACK SILICONE - 80ml CARTRIDGE</td> <td>1.000</td> <td>PC</td> </tr> <tr> <td>VI1220A1</td> <td>4,2x12 TCB SELF-TAPPIN G SCREW</td> <td>2.000</td> <td>PC</td> </tr> </tbody> </table>	Code	Description	Qty	UOM	GN1672A1	BREAKING ELEMENT GASKET	1.000	PC	RS1036A0		1.000	PC	SL1045A0	S57 BLACK SILICONE - 80ml CARTRIDGE	1.000	PC	VI1220A1	4,2x12 TCB SELF-TAPPIN G SCREW	2.000	PC
Code	Description	Qty	UOM																						
GN1672A1	BREAKING ELEMENT GASKET	1.000	PC																						
RS1036A0		1.000	PC																						
SL1045A0	S57 BLACK SILICONE - 80ml CARTRIDGE	1.000	PC																						
VI1220A1	4,2x12 TCB SELF-TAPPIN G SCREW	2.000	PC																						
0H4305A	ST. STEEL MOTOR SHAFT SEALING DIS		K0H4305A	SEALING DISC FOR MOTOR SHAFT KIT	<table border="1"> <thead> <tr> <th>Code</th> <th>Description</th> <th>Qty</th> <th>UOM</th> </tr> </thead> <tbody> <tr> <td>0H4305A1</td> <td>ST. STEEL MOTOR SHAFT SEALING DISC</td> <td>1.000</td> <td>PC</td> </tr> <tr> <td>GN1140A3</td> <td>MOLDED MOTOR HOLDER GASKET</td> <td>1.000</td> <td>PC</td> </tr> <tr> <td>SL1045A0</td> <td>S57 BLACK SILICONE - 80ml CARTRIDGE</td> <td>1.000</td> <td>PC</td> </tr> <tr> <td>VI1220A1</td> <td>4,2x12 TCB SELF-TAPPIN G SCREW</td> <td>3.000</td> <td>PC</td> </tr> </tbody> </table>	Code	Description	Qty	UOM	0H4305A1	ST. STEEL MOTOR SHAFT SEALING DISC	1.000	PC	GN1140A3	MOLDED MOTOR HOLDER GASKET	1.000	PC	SL1045A0	S57 BLACK SILICONE - 80ml CARTRIDGE	1.000	PC	VI1220A1	4,2x12 TCB SELF-TAPPIN G SCREW	3.000	PC
Code	Description	Qty	UOM																						
0H4305A1	ST. STEEL MOTOR SHAFT SEALING DISC	1.000	PC																						
GN1140A3	MOLDED MOTOR HOLDER GASKET	1.000	PC																						
SL1045A0	S57 BLACK SILICONE - 80ml CARTRIDGE	1.000	PC																						
VI1220A1	4,2x12 TCB SELF-TAPPIN G SCREW	3.000	PC																						
0H7170A	MM MOTOR GLASS WOOL PLATE		0H7170A0	MM MOTOR GLASS WOOL PLATE																					
GN1140A	MOLDED MOTOR HOLDER GASKET		KG1140A	5 PCS. MOTOR HOLDER GASKET KI	<table border="1"> <thead> <tr> <th>Code</th> <th>Description</th> <th>Qty</th> <th>UOM</th> </tr> </thead> <tbody> <tr> <td>GN1140A3</td> <td>MOLDED MOTOR HOLDER GASKET</td> <td>5.000</td> <td>PC</td> </tr> </tbody> </table>	Code	Description	Qty	UOM	GN1140A3	MOLDED MOTOR HOLDER GASKET	5.000	PC												
Code	Description	Qty	UOM																						
GN1140A3	MOLDED MOTOR HOLDER GASKET	5.000	PC																						



COMPONENT			SPARE PART																																							
Code	Description	Image	Code	Description	Kit components																																					
MT1012A	330W 230V MOTOR		KVN1130A	LUX ≤08.2017/L.MISS/S.5/ 5E MOTOR KIT	<table border="1"> <thead> <tr> <th>Code</th> <th>Description</th> <th>Qty</th> <th>UOM</th> </tr> </thead> <tbody> <tr> <td>0H4305A1</td> <td>ST. STEEL MOTOR SHAFT SEALING DISC</td> <td>1.000</td> <td>PC</td> </tr> <tr> <td>GN1140A3</td> <td>MOLDED MOTOR HOLDER GASKET</td> <td>1.000</td> <td>PC</td> </tr> <tr> <td>VI1034A0</td> <td>STAINLESS STEEL WASHER 8.4x16x1</td> <td>1.000</td> <td>PC</td> </tr> <tr> <td>VI1256A0</td> <td>M8 DIN 980M ST. STEEL SELF LOCKING NUT</td> <td>1.000</td> <td>PC</td> </tr> <tr> <td>VM2196A0</td> <td>MOTOR NUT FASTENING BUSHING</td> <td>1.000</td> <td>PC</td> </tr> <tr> <td>VN1130A1</td> <td>330W 230V 50/60HZ MOTO</td> <td>1.000</td> <td>PC</td> </tr> </tbody> </table>	Code	Description	Qty	UOM	0H4305A1	ST. STEEL MOTOR SHAFT SEALING DISC	1.000	PC	GN1140A3	MOLDED MOTOR HOLDER GASKET	1.000	PC	VI1034A0	STAINLESS STEEL WASHER 8.4x16x1	1.000	PC	VI1256A0	M8 DIN 980M ST. STEEL SELF LOCKING NUT	1.000	PC	VM2196A0	MOTOR NUT FASTENING BUSHING	1.000	PC	VN1130A1	330W 230V 50/60HZ MOTO	1.000	PC									
			Code	Description	Qty	UOM																																				
0H4305A1	ST. STEEL MOTOR SHAFT SEALING DISC	1.000	PC																																							
GN1140A3	MOLDED MOTOR HOLDER GASKET	1.000	PC																																							
VI1034A0	STAINLESS STEEL WASHER 8.4x16x1	1.000	PC																																							
VI1256A0	M8 DIN 980M ST. STEEL SELF LOCKING NUT	1.000	PC																																							
VM2196A0	MOTOR NUT FASTENING BUSHING	1.000	PC																																							
VN1130A1	330W 230V 50/60HZ MOTO	1.000	PC																																							
KMT1012A	LUX >08.2017 / MIND.MAPS 330W MOTOR KIT	<table border="1"> <thead> <tr> <th>Code</th> <th>Description</th> <th>Qty</th> <th>UOM</th> </tr> </thead> <tbody> <tr> <td>0H2842A0</td> <td>MT1012 CENTERING JI</td> <td>1.000</td> <td>PC</td> </tr> <tr> <td>0H4305A1</td> <td>ST. STEEL MOTOR SHAFT SEALING DISC</td> <td>1.000</td> <td>PC</td> </tr> <tr> <td>GN1140A3</td> <td>MOLDED MOTOR HOLDER GASKET</td> <td>1.000</td> <td>PC</td> </tr> <tr> <td>MT1012A0</td> <td>330W 230V MOTOR</td> <td>1.000</td> <td>PC</td> </tr> <tr> <td>VE1550A0</td> <td>5X3 MM NEODYMIUM MAGNET</td> <td>1.000</td> <td>PC</td> </tr> <tr> <td>VI1077A1</td> <td>SCREW M6x12 TE INOX</td> <td>1.000</td> <td>PC</td> </tr> <tr> <td>VI1521A0</td> <td>STAINLESS STEEL WASHER D=6 6592</td> <td>1.000</td> <td>PC</td> </tr> <tr> <td>VI1966A0</td> <td>M4X14 FLATHEAD SCREW</td> <td>1.000</td> <td>PC</td> </tr> <tr> <td>VM1635A0</td> <td>MAGNET HOLDING DIS</td> <td>1.000</td> <td>PC</td> </tr> </tbody> </table>	Code	Description	Qty	UOM	0H2842A0	MT1012 CENTERING JI	1.000	PC	0H4305A1	ST. STEEL MOTOR SHAFT SEALING DISC	1.000	PC	GN1140A3	MOLDED MOTOR HOLDER GASKET	1.000	PC	MT1012A0	330W 230V MOTOR	1.000	PC	VE1550A0	5X3 MM NEODYMIUM MAGNET	1.000	PC	VI1077A1	SCREW M6x12 TE INOX	1.000	PC	VI1521A0	STAINLESS STEEL WASHER D=6 6592	1.000	PC	VI1966A0	M4X14 FLATHEAD SCREW	1.000	PC	VM1635A0	MAGNET HOLDING DIS	1.000	PC
Code	Description	Qty	UOM																																							
0H2842A0	MT1012 CENTERING JI	1.000	PC																																							
0H4305A1	ST. STEEL MOTOR SHAFT SEALING DISC	1.000	PC																																							
GN1140A3	MOLDED MOTOR HOLDER GASKET	1.000	PC																																							
MT1012A0	330W 230V MOTOR	1.000	PC																																							
VE1550A0	5X3 MM NEODYMIUM MAGNET	1.000	PC																																							
VI1077A1	SCREW M6x12 TE INOX	1.000	PC																																							
VI1521A0	STAINLESS STEEL WASHER D=6 6592	1.000	PC																																							
VI1966A0	M4X14 FLATHEAD SCREW	1.000	PC																																							
VM1635A0	MAGNET HOLDING DIS	1.000	PC																																							

COMPONENT			SPARE PART																										
Code	Description	Image	Code	Description	Kit components																								
VN1170B	D195 H80 8 BLADES FAN+RING		KVN1184A	D195 H80 8 CONCAVE BLADES FAN KIT	<table border="1"> <thead> <tr> <th>Code</th> <th>Description</th> <th>Qty</th> <th>UOM</th> </tr> </thead> <tbody> <tr> <td>VI1122A0</td> <td>A4 316 M6X12 SCREW</td> <td>1.000</td> <td>PC</td> </tr> <tr> <td>VI1123A0</td> <td>A4 ST. STEEL FLAT WASHER FOR M6</td> <td>1.000</td> <td>PC</td> </tr> <tr> <td>VN1184A0</td> <td>D195 H80 8 CONCAVE BLADES FAN</td> <td>1.000</td> <td>PC</td> </tr> </tbody> </table>	Code	Description	Qty	UOM	VI1122A0	A4 316 M6X12 SCREW	1.000	PC	VI1123A0	A4 ST. STEEL FLAT WASHER FOR M6	1.000	PC	VN1184A0	D195 H80 8 CONCAVE BLADES FAN	1.000	PC								
					Code	Description	Qty	UOM																					
					VI1122A0	A4 316 M6X12 SCREW	1.000	PC																					
					VI1123A0	A4 ST. STEEL FLAT WASHER FOR M6	1.000	PC																					
VN1184A0	D195 H80 8 CONCAVE BLADES FAN	1.000	PC																										
OG1585B	OG1585B0		K0G1585B	XEBC-04EU-E COMPLETE FAN GUARD KIT	<table border="1"> <thead> <tr> <th>Code</th> <th>Description</th> <th>Qty</th> <th>UOM</th> </tr> </thead> <tbody> <tr> <td>OG1585B0</td> <td>OG1585B0</td> <td>1.000</td> <td>PC</td> </tr> <tr> <td>TB3061A0</td> <td>XEBC-04EU-E INTERNAL HUMIDITY PIP</td> <td>2.000</td> <td>PC</td> </tr> <tr> <td>VI1220A1</td> <td>4,2x12 TCB SELF-TAPPIN G SCREW</td> <td>2.000</td> <td>PC</td> </tr> </tbody> </table>	Code	Description	Qty	UOM	OG1585B0	OG1585B0	1.000	PC	TB3061A0	XEBC-04EU-E INTERNAL HUMIDITY PIP	2.000	PC	VI1220A1	4,2x12 TCB SELF-TAPPIN G SCREW	2.000	PC								
					Code	Description	Qty	UOM																					
					OG1585B0	OG1585B0	1.000	PC																					
TB3061A0	XEBC-04EU-E INTERNAL HUMIDITY PIP	2.000	PC																										
VI1220A1	4,2x12 TCB SELF-TAPPIN G SCREW	2.000	PC																										
TB3061A	XEBC-04EU-E INTERNAL HUMIDITY PIPE																												
TB3061A	XEBC-04EU-E INTERNAL HUMIDITY PIPE		TB3061A0	XEBC-04EU-E INTERNAL HUMIDITY PIPE																									
GN1584A	CORNER FITTING D30-D16		KGN1584A	D30-D16 CORNER FITTING KIT	<table border="1"> <thead> <tr> <th>Code</th> <th>Description</th> <th>Qty</th> <th>UOM</th> </tr> </thead> <tbody> <tr> <td>GN1584A0</td> <td>CORNER FITTING D30-D16</td> <td>1.000</td> <td>PC</td> </tr> </tbody> </table>	Code	Description	Qty	UOM	GN1584A0	CORNER FITTING D30-D16	1.000	PC																
					Code	Description	Qty	UOM																					
GN1584A0	CORNER FITTING D30-D16	1.000	PC																										
RC1042A	DOUBLE WIRE SPRING CLAMP D21.5-22.6		KTB3074B	XEVC-0711-G VENTURI COLLECTOR PIPE KI	<table border="1"> <thead> <tr> <th>Code</th> <th>Description</th> <th>Qty</th> <th>UOM</th> </tr> </thead> <tbody> <tr> <td>GN1544A0</td> <td>AIR INLET GASKET</td> <td>1.000</td> <td>PC</td> </tr> <tr> <td>GN1584A0</td> <td>CORNER FITTING D30-D16</td> <td>1.000</td> <td>PC</td> </tr> <tr> <td>RC1042A0</td> <td>DOUBLE WIRE SPRING CLAMP D21.5-22.6</td> <td>1.000</td> <td>PC</td> </tr> <tr> <td>TB3074B0</td> <td>XEVC-07EU-G VENTURI COLLECTOR PIPE D30</td> <td>1.000</td> <td>PC</td> </tr> <tr> <td>VM1794A0</td> <td>250x4.8 PA66 BLACK CLAMP</td> <td>1.000</td> <td>PC</td> </tr> </tbody> </table>	Code	Description	Qty	UOM	GN1544A0	AIR INLET GASKET	1.000	PC	GN1584A0	CORNER FITTING D30-D16	1.000	PC	RC1042A0	DOUBLE WIRE SPRING CLAMP D21.5-22.6	1.000	PC	TB3074B0	XEVC-07EU-G VENTURI COLLECTOR PIPE D30	1.000	PC	VM1794A0	250x4.8 PA66 BLACK CLAMP	1.000	PC
Code	Description	Qty	UOM																										
GN1544A0	AIR INLET GASKET	1.000	PC																										
GN1584A0	CORNER FITTING D30-D16	1.000	PC																										
RC1042A0	DOUBLE WIRE SPRING CLAMP D21.5-22.6	1.000	PC																										
TB3074B0	XEVC-07EU-G VENTURI COLLECTOR PIPE D30	1.000	PC																										
VM1794A0	250x4.8 PA66 BLACK CLAMP	1.000	PC																										





COMPONENT			SPARE PART																										
Code	Description	Image	Code	Description	Kit components																								
RC1042A	DOUBLE WIRE SPRING CLAMP D21.5-22.6		KTB3068B	10FS/EU/2-G VENTURI COLLECTOR PIPE KI	<table border="1"> <thead> <tr> <th>Code</th> <th>Description</th> <th>Qty</th> <th>UOM</th> </tr> </thead> <tbody> <tr> <td>GN1544A0</td> <td>AIR INLET GASKET</td> <td>2.000</td> <td>PC</td> </tr> <tr> <td>GN1584A0</td> <td>CORNER FITTING D30-D16</td> <td>1.000</td> <td>PC</td> </tr> <tr> <td>RC1042A0</td> <td>DOUBLE WIRE SPRING CLAMP D21.5-22.6</td> <td>1.000</td> <td>PC</td> </tr> <tr> <td>TB3068B0</td> <td>XEBC-10 VENTURI AIR COLLECTOR PIPE D30</td> <td>1.000</td> <td>PC</td> </tr> <tr> <td>VM1794A0</td> <td>250x4.8 PA66 BLACK CLAMP</td> <td>1.000</td> <td>PC</td> </tr> </tbody> </table>	Code	Description	Qty	UOM	GN1544A0	AIR INLET GASKET	2.000	PC	GN1584A0	CORNER FITTING D30-D16	1.000	PC	RC1042A0	DOUBLE WIRE SPRING CLAMP D21.5-22.6	1.000	PC	TB3068B0	XEBC-10 VENTURI AIR COLLECTOR PIPE D30	1.000	PC	VM1794A0	250x4.8 PA66 BLACK CLAMP	1.000	PC
					Code	Description	Qty	UOM																					
					GN1544A0	AIR INLET GASKET	2.000	PC																					
					GN1584A0	CORNER FITTING D30-D16	1.000	PC																					
			RC1042A0	DOUBLE WIRE SPRING CLAMP D21.5-22.6	1.000	PC																							
			TB3068B0	XEBC-10 VENTURI AIR COLLECTOR PIPE D30	1.000	PC																							
			VM1794A0	250x4.8 PA66 BLACK CLAMP	1.000	PC																							
			KTB3019A	20XX/16XX UPPER VENTURI COLLECT PIPE KIT	<table border="1"> <thead> <tr> <th>Code</th> <th>Description</th> <th>Qty</th> <th>UOM</th> </tr> </thead> <tbody> <tr> <td>GN1544A0</td> <td>AIR INLET GASKET</td> <td>1.000</td> <td>PC</td> </tr> <tr> <td>GN1584A0</td> <td>CORNER FITTING D30-D16</td> <td>1.000</td> <td>PC</td> </tr> <tr> <td>RC1042A0</td> <td>DOUBLE WIRE SPRING CLAMP D21.5-22.6</td> <td>1.000</td> <td>PC</td> </tr> <tr> <td>TB3019A1</td> <td>XEVC-2011 UPPER AIR INLET PIPE D3</td> <td>1.000</td> <td>PC</td> </tr> <tr> <td>VM1794A0</td> <td>250x4.8 PA66 BLACK CLAMP</td> <td>1.000</td> <td>PC</td> </tr> </tbody> </table>	Code	Description	Qty	UOM	GN1544A0	AIR INLET GASKET	1.000	PC	GN1584A0	CORNER FITTING D30-D16	1.000	PC	RC1042A0	DOUBLE WIRE SPRING CLAMP D21.5-22.6	1.000	PC	TB3019A1	XEVC-2011 UPPER AIR INLET PIPE D3	1.000	PC	VM1794A0	250x4.8 PA66 BLACK CLAMP	1.000	PC
					Code	Description	Qty	UOM																					
					GN1544A0	AIR INLET GASKET	1.000	PC																					
					GN1584A0	CORNER FITTING D30-D16	1.000	PC																					
			RC1042A0	DOUBLE WIRE SPRING CLAMP D21.5-22.6	1.000	PC																							
TB3019A1	XEVC-2011 UPPER AIR INLET PIPE D3	1.000	PC																										
VM1794A0	250x4.8 PA66 BLACK CLAMP	1.000	PC																										
KTB2979C	XEBC-10XX-E VENTURI COLLECTOR PIPE KI	<table border="1"> <thead> <tr> <th>Code</th> <th>Description</th> <th>Qty</th> <th>UOM</th> </tr> </thead> <tbody> <tr> <td>GN1544A0</td> <td>AIR INLET GASKET</td> <td>2.000</td> <td>PC</td> </tr> <tr> <td>GN1584A0</td> <td>CORNER FITTING D30-D16</td> <td>1.000</td> <td>PC</td> </tr> <tr> <td>RC1042A0</td> <td>DOUBLE WIRE SPRING CLAMP D21.5-22.6</td> <td>1.000</td> <td>PC</td> </tr> <tr> <td>TB2979C0</td> <td>XEBC-10 VENTURI AIR COLLECTOR PIPE D30</td> <td>1.000</td> <td>PC</td> </tr> <tr> <td>VM1794A0</td> <td>250x4.8 PA66 BLACK CLAMP</td> <td>1.000</td> <td>PC</td> </tr> </tbody> </table>	Code	Description	Qty	UOM	GN1544A0	AIR INLET GASKET	2.000	PC	GN1584A0	CORNER FITTING D30-D16	1.000	PC	RC1042A0	DOUBLE WIRE SPRING CLAMP D21.5-22.6	1.000	PC	TB2979C0	XEBC-10 VENTURI AIR COLLECTOR PIPE D30	1.000	PC	VM1794A0	250x4.8 PA66 BLACK CLAMP	1.000	PC			
		Code	Description	Qty	UOM																								
		GN1544A0	AIR INLET GASKET	2.000	PC																								
		GN1584A0	CORNER FITTING D30-D16	1.000	PC																								
RC1042A0	DOUBLE WIRE SPRING CLAMP D21.5-22.6	1.000	PC																										
TB2979C0	XEBC-10 VENTURI AIR COLLECTOR PIPE D30	1.000	PC																										
VM1794A0	250x4.8 PA66 BLACK CLAMP	1.000	PC																										
KTB2978B	XEBC-06 VENTURI COLLECTOR PIPE KI	<table border="1"> <thead> <tr> <th>Code</th> <th>Description</th> <th>Qty</th> <th>UOM</th> </tr> </thead> <tbody> <tr> <td>GN1544A0</td> <td>AIR INLET GASKET</td> <td>1.000</td> <td>PC</td> </tr> </tbody> </table>	Code	Description	Qty	UOM	GN1544A0	AIR INLET GASKET	1.000	PC																			
		Code	Description	Qty	UOM																								
GN1544A0	AIR INLET GASKET	1.000	PC																										

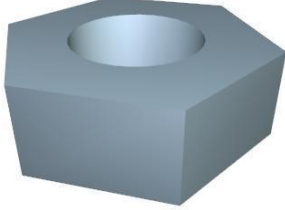

COMPONENT			SPARE PART										
Code	Description	Image	Code	Description	Kit components								
RC1042A	DOUBLE WIRE SPRING CLAMP D21.5-22.6		KTB2978B	XEBC-06 VENTURI COLLECTOR PIPE KI	<table border="1"> <thead> <tr> <th>Code</th> <th>Description</th> <th>Qty</th> <th>UOM</th> </tr> </thead> <tbody> <tr> <td>GN1584A0</td> <td>CORNER FITTING D30-D16</td> <td>1.000</td> <td>PC</td> </tr> </tbody> </table>	Code	Description	Qty	UOM	GN1584A0	CORNER FITTING D30-D16	1.000	PC
					Code	Description	Qty	UOM					
					GN1584A0	CORNER FITTING D30-D16	1.000	PC					
					<table border="1"> <thead> <tr> <th>Code</th> <th>Description</th> <th>Qty</th> <th>UOM</th> </tr> </thead> <tbody> <tr> <td>RC1042A0</td> <td>DOUBLE WIRE SPRING CLAMP D21.5-22.6</td> <td>1.000</td> <td>PC</td> </tr> </tbody> </table>	Code	Description	Qty	UOM	RC1042A0	DOUBLE WIRE SPRING CLAMP D21.5-22.6	1.000	PC
			Code	Description	Qty	UOM							
			RC1042A0	DOUBLE WIRE SPRING CLAMP D21.5-22.6	1.000	PC							
			<table border="1"> <thead> <tr> <th>Code</th> <th>Description</th> <th>Qty</th> <th>UOM</th> </tr> </thead> <tbody> <tr> <td>TB2978B0</td> <td>XEBC-06 VENTURI AIR COLLECTOR PIPE D30</td> <td>1.000</td> <td>PC</td> </tr> </tbody> </table>	Code	Description	Qty	UOM	TB2978B0	XEBC-06 VENTURI AIR COLLECTOR PIPE D30	1.000	PC		
			Code	Description	Qty	UOM							
			TB2978B0	XEBC-06 VENTURI AIR COLLECTOR PIPE D30	1.000	PC							
			<table border="1"> <thead> <tr> <th>Code</th> <th>Description</th> <th>Qty</th> <th>UOM</th> </tr> </thead> <tbody> <tr> <td>VM1794A0</td> <td>250x4.8 PA66 BLACK CLAMP</td> <td>1.000</td> <td>PC</td> </tr> </tbody> </table>	Code	Description	Qty	UOM	VM1794A0	250x4.8 PA66 BLACK CLAMP	1.000	PC		
			Code	Description	Qty	UOM							
			VM1794A0	250x4.8 PA66 BLACK CLAMP	1.000	PC							
KTB2959B	XEVC-1011-E VENTURI COLLECTOR PIPE KI	<table border="1"> <thead> <tr> <th>Code</th> <th>Description</th> <th>Qty</th> <th>UOM</th> </tr> </thead> <tbody> <tr> <td>GN1544A0</td> <td>AIR INLET GASKET</td> <td>2.000</td> <td>PC</td> </tr> </tbody> </table>	Code	Description	Qty	UOM	GN1544A0	AIR INLET GASKET	2.000	PC			
		Code	Description	Qty	UOM								
		GN1544A0	AIR INLET GASKET	2.000	PC								
		<table border="1"> <thead> <tr> <th>Code</th> <th>Description</th> <th>Qty</th> <th>UOM</th> </tr> </thead> <tbody> <tr> <td>GN1584A0</td> <td>CORNER FITTING D30-D16</td> <td>1.000</td> <td>PC</td> </tr> </tbody> </table>	Code	Description	Qty	UOM	GN1584A0	CORNER FITTING D30-D16	1.000	PC			
Code	Description	Qty	UOM										
GN1584A0	CORNER FITTING D30-D16	1.000	PC										
<table border="1"> <thead> <tr> <th>Code</th> <th>Description</th> <th>Qty</th> <th>UOM</th> </tr> </thead> <tbody> <tr> <td>RC1042A0</td> <td>DOUBLE WIRE SPRING CLAMP D21.5-22.6</td> <td>1.000</td> <td>PC</td> </tr> </tbody> </table>	Code	Description	Qty	UOM	RC1042A0	DOUBLE WIRE SPRING CLAMP D21.5-22.6	1.000	PC					
Code	Description	Qty	UOM										
RC1042A0	DOUBLE WIRE SPRING CLAMP D21.5-22.6	1.000	PC										
<table border="1"> <thead> <tr> <th>Code</th> <th>Description</th> <th>Qty</th> <th>UOM</th> </tr> </thead> <tbody> <tr> <td>TB2959B0</td> <td>XEVC-1011-E VENTURI PIPE</td> <td>1.000</td> <td>PC</td> </tr> </tbody> </table>	Code	Description	Qty	UOM	TB2959B0	XEVC-1011-E VENTURI PIPE	1.000	PC					
Code	Description	Qty	UOM										
TB2959B0	XEVC-1011-E VENTURI PIPE	1.000	PC										
KTB2958B	XEVC-0711-E VENTURI COLLECTOR PIPE KI	<table border="1"> <thead> <tr> <th>Code</th> <th>Description</th> <th>Qty</th> <th>UOM</th> </tr> </thead> <tbody> <tr> <td>GN1544A0</td> <td>AIR INLET GASKET</td> <td>1.000</td> <td>PC</td> </tr> </tbody> </table>	Code	Description	Qty	UOM	GN1544A0	AIR INLET GASKET	1.000	PC			
		Code	Description	Qty	UOM								
		GN1544A0	AIR INLET GASKET	1.000	PC								
		<table border="1"> <thead> <tr> <th>Code</th> <th>Description</th> <th>Qty</th> <th>UOM</th> </tr> </thead> <tbody> <tr> <td>GN1584A0</td> <td>CORNER FITTING D30-D16</td> <td>1.000</td> <td>PC</td> </tr> </tbody> </table>	Code	Description	Qty	UOM	GN1584A0	CORNER FITTING D30-D16	1.000	PC			
Code	Description	Qty	UOM										
GN1584A0	CORNER FITTING D30-D16	1.000	PC										
<table border="1"> <thead> <tr> <th>Code</th> <th>Description</th> <th>Qty</th> <th>UOM</th> </tr> </thead> <tbody> <tr> <td>RC1042A0</td> <td>DOUBLE WIRE SPRING CLAMP D21.5-22.6</td> <td>1.000</td> <td>PC</td> </tr> </tbody> </table>	Code	Description	Qty	UOM	RC1042A0	DOUBLE WIRE SPRING CLAMP D21.5-22.6	1.000	PC					
Code	Description	Qty	UOM										
RC1042A0	DOUBLE WIRE SPRING CLAMP D21.5-22.6	1.000	PC										
<table border="1"> <thead> <tr> <th>Code</th> <th>Description</th> <th>Qty</th> <th>UOM</th> </tr> </thead> <tbody> <tr> <td>TB2958B0</td> <td>XEVC-0711-E VENTURI PIPE</td> <td>1.000</td> <td>PC</td> </tr> </tbody> </table>	Code	Description	Qty	UOM	TB2958B0	XEVC-0711-E VENTURI PIPE	1.000	PC					
Code	Description	Qty	UOM										
TB2958B0	XEVC-0711-E VENTURI PIPE	1.000	PC										
KTB2957B	0511/04EU-E VENTURI COLLECTOR PIPE KI	<table border="1"> <thead> <tr> <th>Code</th> <th>Description</th> <th>Qty</th> <th>UOM</th> </tr> </thead> <tbody> <tr> <td>GN1544A0</td> <td>AIR INLET GASKET</td> <td>1.000</td> <td>PC</td> </tr> </tbody> </table>	Code	Description	Qty	UOM	GN1544A0	AIR INLET GASKET	1.000	PC			
		Code	Description	Qty	UOM								
		GN1544A0	AIR INLET GASKET	1.000	PC								
		<table border="1"> <thead> <tr> <th>Code</th> <th>Description</th> <th>Qty</th> <th>UOM</th> </tr> </thead> <tbody> <tr> <td>GN1584A0</td> <td>CORNER FITTING D30-D16</td> <td>1.000</td> <td>PC</td> </tr> </tbody> </table>	Code	Description	Qty	UOM	GN1584A0	CORNER FITTING D30-D16	1.000	PC			
		Code	Description	Qty	UOM								
GN1584A0	CORNER FITTING D30-D16	1.000	PC										
<table border="1"> <thead> <tr> <th>Code</th> <th>Description</th> <th>Qty</th> <th>UOM</th> </tr> </thead> <tbody> <tr> <td>RC1042A0</td> <td>DOUBLE WIRE SPRING CLAMP D21.5-22.6</td> <td>1.000</td> <td>PC</td> </tr> </tbody> </table>	Code	Description	Qty	UOM	RC1042A0	DOUBLE WIRE SPRING CLAMP D21.5-22.6	1.000	PC					
Code	Description	Qty	UOM										
RC1042A0	DOUBLE WIRE SPRING CLAMP D21.5-22.6	1.000	PC										
<table border="1"> <thead> <tr> <th>Code</th> <th>Description</th> <th>Qty</th> <th>UOM</th> </tr> </thead> <tbody> <tr> <td>TB2957B0</td> <td>XEVC-0511-E VENTURI PIPE</td> <td>1.000</td> <td>PC</td> </tr> </tbody> </table>	Code	Description	Qty	UOM	TB2957B0	XEVC-0511-E VENTURI PIPE	1.000	PC					
Code	Description	Qty	UOM										
TB2957B0	XEVC-0511-E VENTURI PIPE	1.000	PC										
<table border="1"> <thead> <tr> <th>Code</th> <th>Description</th> <th>Qty</th> <th>UOM</th> </tr> </thead> <tbody> <tr> <td>VM1794A0</td> <td>250x4.8 PA66 BLACK CLAMP</td> <td>1.000</td> <td>PC</td> </tr> </tbody> </table>	Code	Description	Qty	UOM	VM1794A0	250x4.8 PA66 BLACK CLAMP	1.000	PC					
Code	Description	Qty	UOM										
VM1794A0	250x4.8 PA66 BLACK CLAMP	1.000	PC										

COMPONENT			SPARE PART																							
Code	Description	Image	Code	Description	Kit components																					
RC1042A	DOUBLE WIRE SPRING CLAMP D21.5-22.6		KTB2956A	'EVC-0311-E VENTURI COLLECTOR PIPE KI	<table border="1"> <thead> <tr> <th>Code</th> <th>Description</th> <th>Qty</th> <th>UOM</th> </tr> </thead> <tbody> <tr> <td>GN1544A0</td> <td>AIR INLET GASKET</td> <td>1.000</td> <td>PC</td> </tr> <tr> <td>RC1042A0</td> <td>DOUBLE WIRE SPRING CLAMP D21.5-22.6</td> <td>1.000</td> <td>PC</td> </tr> <tr> <td>TB2956A0</td> <td>XEVC-0311-E VENTURI PIPE</td> <td>1.000</td> <td>PC</td> </tr> </tbody> </table>	Code	Description	Qty	UOM	GN1544A0	AIR INLET GASKET	1.000	PC	RC1042A0	DOUBLE WIRE SPRING CLAMP D21.5-22.6	1.000	PC	TB2956A0	XEVC-0311-E VENTURI PIPE	1.000	PC					
			Code	Description	Qty	UOM																				
			GN1544A0	AIR INLET GASKET	1.000	PC																				
RC1042A0	DOUBLE WIRE SPRING CLAMP D21.5-22.6	1.000	PC																							
TB2956A0	XEVC-0311-E VENTURI PIPE	1.000	PC																							
KTB2944A	20XX/16XX LOWER VENTURI COLLECT PIPE KIT	<table border="1"> <thead> <tr> <th>Code</th> <th>Description</th> <th>Qty</th> <th>UOM</th> </tr> </thead> <tbody> <tr> <td>GN1544A0</td> <td>AIR INLET GASKET</td> <td>2.000</td> <td>PC</td> </tr> <tr> <td>GN1584A0</td> <td>CORNER FITTING D30-D16</td> <td>1.000</td> <td>PC</td> </tr> <tr> <td>RC1042A0</td> <td>DOUBLE WIRE SPRING CLAMP D21.5-22.6</td> <td>1.000</td> <td>PC</td> </tr> <tr> <td>TB2944A1</td> <td>XEVC-2011 AIR INLET PIPE D3</td> <td>1.000</td> <td>PC</td> </tr> <tr> <td>VM1794A0</td> <td>250x4.8 PA66 BLACK CLAMP</td> <td>1.000</td> <td>PC</td> </tr> </tbody> </table>	Code	Description	Qty	UOM	GN1544A0	AIR INLET GASKET	2.000	PC	GN1584A0	CORNER FITTING D30-D16	1.000	PC	RC1042A0	DOUBLE WIRE SPRING CLAMP D21.5-22.6	1.000	PC	TB2944A1	XEVC-2011 AIR INLET PIPE D3	1.000	PC	VM1794A0	250x4.8 PA66 BLACK CLAMP	1.000	PC
Code	Description	Qty	UOM																							
GN1544A0	AIR INLET GASKET	2.000	PC																							
GN1584A0	CORNER FITTING D30-D16	1.000	PC																							
RC1042A0	DOUBLE WIRE SPRING CLAMP D21.5-22.6	1.000	PC																							
TB2944A1	XEVC-2011 AIR INLET PIPE D3	1.000	PC																							
VM1794A0	250x4.8 PA66 BLACK CLAMP	1.000	PC																							
KRC1042A	10PCS CLAMP BIFIL SPRING D21.5-22.6 KIT	<table border="1"> <thead> <tr> <th>Code</th> <th>Description</th> <th>Qty</th> <th>UOM</th> </tr> </thead> <tbody> <tr> <td>RC1042A0</td> <td>DOUBLE WIRE SPRING CLAMP D21.5-22.6</td> <td>10.000</td> <td>PC</td> </tr> </tbody> </table>	Code	Description	Qty	UOM	RC1042A0	DOUBLE WIRE SPRING CLAMP D21.5-22.6	10.000	PC																
Code	Description	Qty	UOM																							
RC1042A0	DOUBLE WIRE SPRING CLAMP D21.5-22.6	10.000	PC																							
RC1378A	HOSE CLAMP		KVM2379A	MM 200V VENTURI ACTUATOR SYSTEM KIT	<table border="1"> <thead> <tr> <th>Code</th> <th>Description</th> <th>Qty</th> <th>UOM</th> </tr> </thead> <tbody> <tr> <td>RC1378A0</td> <td>HOSE CLAMP</td> <td>3.000</td> <td>PC</td> </tr> <tr> <td>TB1520A0</td> <td>Int. Ø=38 TH=4 DRAIN BLACK RUBBER PIPE</td> <td>0.120</td> <td>M</td> </tr> <tr> <td>VM2379A1</td> <td></td> <td>1.000</td> <td>PC</td> </tr> </tbody> </table>	Code	Description	Qty	UOM	RC1378A0	HOSE CLAMP	3.000	PC	TB1520A0	Int. Ø=38 TH=4 DRAIN BLACK RUBBER PIPE	0.120	M	VM2379A1		1.000	PC					
			Code	Description	Qty	UOM																				
			RC1378A0	HOSE CLAMP	3.000	PC																				
			TB1520A0	Int. Ø=38 TH=4 DRAIN BLACK RUBBER PIPE	0.120	M																				
			VM2379A1		1.000	PC																				
			KVM2378A	MM 240V VENTURI ACTUATOR SYSTEM KIT	<table border="1"> <thead> <tr> <th>Code</th> <th>Description</th> <th>Qty</th> <th>UOM</th> </tr> </thead> <tbody> <tr> <td>RC1378A0</td> <td>HOSE CLAMP</td> <td>3.000</td> <td>PC</td> </tr> <tr> <td>TB1520A0</td> <td>Int. Ø=38 TH=4 DRAIN BLACK RUBBER PIPE</td> <td>0.120</td> <td>M</td> </tr> <tr> <td>VM2378A1</td> <td></td> <td>1.000</td> <td>PC</td> </tr> </tbody> </table>	Code	Description	Qty	UOM	RC1378A0	HOSE CLAMP	3.000	PC	TB1520A0	Int. Ø=38 TH=4 DRAIN BLACK RUBBER PIPE	0.120	M	VM2378A1		1.000	PC					
			Code	Description	Qty	UOM																				
			RC1378A0	HOSE CLAMP	3.000	PC																				
			TB1520A0	Int. Ø=38 TH=4 DRAIN BLACK RUBBER PIPE	0.120	M																				
VM2378A1		1.000	PC																							
KVM2377A	MM 220 V VENTURI ACTUATOR SYSTEM KIT	<table border="1"> <thead> <tr> <th>Code</th> <th>Description</th> <th>Qty</th> <th>UOM</th> </tr> </thead> <tbody> <tr> <td>RC1378A0</td> <td>HOSE CLAMP</td> <td>3.000</td> <td>PC</td> </tr> <tr> <td>TB1520A0</td> <td>Int. Ø=38 TH=4 DRAIN BLACK RUBBER PIPE</td> <td>0.120</td> <td>M</td> </tr> <tr> <td>VM2377A1</td> <td>220 V 50/60 HZ EUR VENTURI SET</td> <td>1.000</td> <td>PC</td> </tr> </tbody> </table>	Code	Description	Qty	UOM	RC1378A0	HOSE CLAMP	3.000	PC	TB1520A0	Int. Ø=38 TH=4 DRAIN BLACK RUBBER PIPE	0.120	M	VM2377A1	220 V 50/60 HZ EUR VENTURI SET	1.000	PC								
Code	Description	Qty	UOM																							
RC1378A0	HOSE CLAMP	3.000	PC																							
TB1520A0	Int. Ø=38 TH=4 DRAIN BLACK RUBBER PIPE	0.120	M																							
VM2377A1	220 V 50/60 HZ EUR VENTURI SET	1.000	PC																							

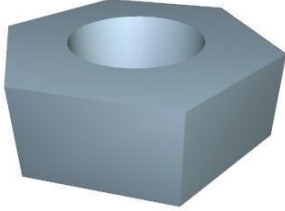
COMPONENT			SPARE PART																										
Code	Description	Image	Code	Description	Kit components																								
RC1378A	HOSE CLAMP		KVE1140A	S.5/5E JAPAN VERSION VENTURI COIL KIT	<table border="1"> <thead> <tr> <th>Code</th> <th>Description</th> <th>Qty</th> <th>UOM</th> </tr> </thead> <tbody> <tr> <td>RC1378A0</td> <td>HOSE CLAMP</td> <td>2.000</td> <td>PC</td> </tr> <tr> <td>TB1520A0</td> <td>Int. Ø=38 TH=4 DRAIN BLACK RUBBER PIPE</td> <td>0.050</td> <td>M</td> </tr> <tr> <td>V11220A1</td> <td>4,2x12 TCB SELF-TAPPIN G SCREW</td> <td>1.000</td> <td>PC</td> </tr> <tr> <td>VM2632A0</td> <td></td> <td>1.000</td> <td>PC</td> </tr> </tbody> </table>	Code	Description	Qty	UOM	RC1378A0	HOSE CLAMP	2.000	PC	TB1520A0	Int. Ø=38 TH=4 DRAIN BLACK RUBBER PIPE	0.050	M	V11220A1	4,2x12 TCB SELF-TAPPIN G SCREW	1.000	PC	VM2632A0		1.000	PC				
			Code	Description	Qty	UOM																							
			RC1378A0	HOSE CLAMP	2.000	PC																							
TB1520A0	Int. Ø=38 TH=4 DRAIN BLACK RUBBER PIPE	0.050	M																										
V11220A1	4,2x12 TCB SELF-TAPPIN G SCREW	1.000	PC																										
VM2632A0		1.000	PC																										
KVE1014A	US VERSION SERIES 5 VENTURI COIL KIT	<table border="1"> <thead> <tr> <th>Code</th> <th>Description</th> <th>Qty</th> <th>UOM</th> </tr> </thead> <tbody> <tr> <td>RC1378A0</td> <td>HOSE CLAMP</td> <td>2.000</td> <td>PC</td> </tr> <tr> <td>TB1520A0</td> <td>Int. Ø=38 TH=4 DRAIN BLACK RUBBER PIPE</td> <td>0.050</td> <td>M</td> </tr> <tr> <td>VM2633A0</td> <td></td> <td>1.000</td> <td>PC</td> </tr> </tbody> </table>	Code	Description	Qty	UOM	RC1378A0	HOSE CLAMP	2.000	PC	TB1520A0	Int. Ø=38 TH=4 DRAIN BLACK RUBBER PIPE	0.050	M	VM2633A0		1.000	PC											
Code	Description	Qty	UOM																										
RC1378A0	HOSE CLAMP	2.000	PC																										
TB1520A0	Int. Ø=38 TH=4 DRAIN BLACK RUBBER PIPE	0.050	M																										
VM2633A0		1.000	PC																										
KRC1378A	HOSE CLAMP 10 PCS KIT	<table border="1"> <thead> <tr> <th>Code</th> <th>Description</th> <th>Qty</th> <th>UOM</th> </tr> </thead> <tbody> <tr> <td>RC1378A0</td> <td>HOSE CLAMP</td> <td>10.000</td> <td>PC</td> </tr> </tbody> </table>	Code	Description	Qty	UOM	RC1378A0	HOSE CLAMP	10.000	PC																			
Code	Description	Qty	UOM																										
RC1378A0	HOSE CLAMP	10.000	PC																										
TB1956A	TB1520A-GREY SILICONE PIPE L=0,04M		KTB1002A	BLACK TUBE KIT EPDM 240MT TB1520A	<table border="1"> <thead> <tr> <th>Code</th> <th>Description</th> <th>Qty</th> <th>UOM</th> </tr> </thead> <tbody> <tr> <td>TB1520A0</td> <td>Int. Ø=38 TH=4 DRAIN BLACK RUBBER PIPE</td> <td>240.000</td> <td>M</td> </tr> </tbody> </table>	Code	Description	Qty	UOM	TB1520A0	Int. Ø=38 TH=4 DRAIN BLACK RUBBER PIPE	240.000	M																
			Code	Description	Qty	UOM																							
			TB1520A0	Int. Ø=38 TH=4 DRAIN BLACK RUBBER PIPE	240.000	M																							
KTB1001A	BLACK TUBE KIT EPDM 10MT TB1520	<table border="1"> <thead> <tr> <th>Code</th> <th>Description</th> <th>Qty</th> <th>UOM</th> </tr> </thead> <tbody> <tr> <td>TB1520A0</td> <td>Int. Ø=38 TH=4 DRAIN BLACK RUBBER PIPE</td> <td>10.000</td> <td>M</td> </tr> <tr> <td>VM1794A0</td> <td>250x4.8 PA66 BLACK CLAMP</td> <td>3.000</td> <td>PC</td> </tr> </tbody> </table>	Code	Description	Qty	UOM	TB1520A0	Int. Ø=38 TH=4 DRAIN BLACK RUBBER PIPE	10.000	M	VM1794A0	250x4.8 PA66 BLACK CLAMP	3.000	PC															
Code	Description	Qty	UOM																										
TB1520A0	Int. Ø=38 TH=4 DRAIN BLACK RUBBER PIPE	10.000	M																										
VM1794A0	250x4.8 PA66 BLACK CLAMP	3.000	PC																										
KTB1000A	EPDM BLACK TUBE TB1520A 2MT KIT	<table border="1"> <thead> <tr> <th>Code</th> <th>Description</th> <th>Qty</th> <th>UOM</th> </tr> </thead> <tbody> <tr> <td>RC1055A0</td> <td>Ø25-40 H12 STAINLESS STEEL PIPE CLIP</td> <td>2.000</td> <td>PC</td> </tr> <tr> <td>TB1520A0</td> <td>Int. Ø=38 TH=4 DRAIN BLACK RUBBER PIPE</td> <td>2.000</td> <td>M</td> </tr> </tbody> </table>	Code	Description	Qty	UOM	RC1055A0	Ø25-40 H12 STAINLESS STEEL PIPE CLIP	2.000	PC	TB1520A0	Int. Ø=38 TH=4 DRAIN BLACK RUBBER PIPE	2.000	M															
Code	Description	Qty	UOM																										
RC1055A0	Ø25-40 H12 STAINLESS STEEL PIPE CLIP	2.000	PC																										
TB1520A0	Int. Ø=38 TH=4 DRAIN BLACK RUBBER PIPE	2.000	M																										
TB2957B	XEVC-0511-E VENTURI PIPE		KTB2957B	0511/04EU-E VENTURI COLLECTOR PIPE KI	<table border="1"> <thead> <tr> <th>Code</th> <th>Description</th> <th>Qty</th> <th>UOM</th> </tr> </thead> <tbody> <tr> <td>GN1544A0</td> <td>AIR INLET GASKET</td> <td>1.000</td> <td>PC</td> </tr> <tr> <td>GN1584A0</td> <td>CORNER FITTING D30-D16</td> <td>1.000</td> <td>PC</td> </tr> <tr> <td>RC1042A0</td> <td>DOUBLE WIRE SPRING CLAMP D21.5-22.6</td> <td>1.000</td> <td>PC</td> </tr> <tr> <td>TB2957B0</td> <td>XEVC-0511-E VENTURI PIPE</td> <td>1.000</td> <td>PC</td> </tr> <tr> <td>VM1794A0</td> <td>250x4.8 PA66 BLACK CLAMP</td> <td>1.000</td> <td>PC</td> </tr> </tbody> </table>	Code	Description	Qty	UOM	GN1544A0	AIR INLET GASKET	1.000	PC	GN1584A0	CORNER FITTING D30-D16	1.000	PC	RC1042A0	DOUBLE WIRE SPRING CLAMP D21.5-22.6	1.000	PC	TB2957B0	XEVC-0511-E VENTURI PIPE	1.000	PC	VM1794A0	250x4.8 PA66 BLACK CLAMP	1.000	PC
Code	Description	Qty	UOM																										
GN1544A0	AIR INLET GASKET	1.000	PC																										
GN1584A0	CORNER FITTING D30-D16	1.000	PC																										
RC1042A0	DOUBLE WIRE SPRING CLAMP D21.5-22.6	1.000	PC																										
TB2957B0	XEVC-0511-E VENTURI PIPE	1.000	PC																										
VM1794A0	250x4.8 PA66 BLACK CLAMP	1.000	PC																										

COMPONENT			SPARE PART																		
Code	Description	Image	Code	Description	Kit components																
VM2377A	220 V 50/60 HZ EUR VENTURI SET		KVM2377A	MM 220 V VENTURI ACTUATOR SYSTEM KIT	<table border="1"> <thead> <tr> <th>Code</th> <th>Description</th> <th>Qty</th> <th>UOM</th> </tr> </thead> <tbody> <tr> <td>RC1378A0</td> <td>HOSE CLAMP</td> <td>3.000</td> <td>PC</td> </tr> <tr> <td>TB1520A0</td> <td>Int. Ø=38 TH=4 DRAIN BLACK RUBBER PIPE</td> <td>0.120</td> <td>M</td> </tr> <tr> <td>VM2377A1</td> <td>220 V 50/60 HZ EUR VENTURI SET</td> <td>1.000</td> <td>PC</td> </tr> </tbody> </table>	Code	Description	Qty	UOM	RC1378A0	HOSE CLAMP	3.000	PC	TB1520A0	Int. Ø=38 TH=4 DRAIN BLACK RUBBER PIPE	0.120	M	VM2377A1	220 V 50/60 HZ EUR VENTURI SET	1.000	PC
Code	Description	Qty	UOM																		
RC1378A0	HOSE CLAMP	3.000	PC																		
TB1520A0	Int. Ø=38 TH=4 DRAIN BLACK RUBBER PIPE	0.120	M																		
VM2377A1	220 V 50/60 HZ EUR VENTURI SET	1.000	PC																		
RC1170A	M14 H=7 CH=22 STAINLESS STEEL NUT		KRC1170A	M14 H8 CH22 NUT - 10 PCS. KIT	<table border="1"> <thead> <tr> <th>Code</th> <th>Description</th> <th>Qty</th> <th>UOM</th> </tr> </thead> <tbody> <tr> <td>RC1170A1</td> <td>M14 H=7 CH=22 STAINLESS STEEL NUT</td> <td>10.000</td> <td>PC</td> </tr> </tbody> </table>	Code	Description	Qty	UOM	RC1170A1	M14 H=7 CH=22 STAINLESS STEEL NUT	10.000	PC								
Code	Description	Qty	UOM																		
RC1170A1	M14 H=7 CH=22 STAINLESS STEEL NUT	10.000	PC																		
TB1379C	XEBC-04 LEFT EXTERNAL WATER PIPE+FITTING		TB1379C0	XEBC-04 LEFT EXTERNAL WATER PIPE+FITTING																	
RC1170A	M14 H=7 CH=22 STAINLESS STEEL NUT		KRC1170A	M14 H8 CH22 NUT - 10 PCS. KIT	<table border="1"> <thead> <tr> <th>Code</th> <th>Description</th> <th>Qty</th> <th>UOM</th> </tr> </thead> <tbody> <tr> <td>RC1170A1</td> <td>M14 H=7 CH=22 STAINLESS STEEL NUT</td> <td>10.000</td> <td>PC</td> </tr> </tbody> </table>	Code	Description	Qty	UOM	RC1170A1	M14 H=7 CH=22 STAINLESS STEEL NUT	10.000	PC								
Code	Description	Qty	UOM																		
RC1170A1	M14 H=7 CH=22 STAINLESS STEEL NUT	10.000	PC																		
TB1381C	XEBC-04 RIGHT EXT WATER PIPE+FITTIN		TB1381C0	XEBC-04 RIGHT EXT WATER PIPE+FITTING																	



COMPONENT			SPARE PART																										
Code	Description	Image	Code	Description	Kit components																								
VL1127A	6mm BARBED T-SHAPED FITTING		KVL1127A	6mm BARBED T-SHAPED FITTING 10 PCS KIT	<table border="1"> <thead> <tr> <th>Code</th> <th>Description</th> <th>Qty</th> <th>UOM</th> </tr> </thead> <tbody> <tr> <td>VL1127A1</td> <td>6mm BARBED T-SHAPED FITTING</td> <td>10.000</td> <td>PC</td> </tr> </tbody> </table>	Code	Description	Qty	UOM	VL1127A1	6mm BARBED T-SHAPED FITTING	10.000	PC																
Code	Description	Qty	UOM																										
VL1127A1	6mm BARBED T-SHAPED FITTING	10.000	PC																										
TB3256A	WHITE-BLUE EPDM 6x12 4cm HOSE-TB3132A		TB3256A0	WHITE-BLUE EPDM 6x12 4cm HOSE-TB3132A																									
0H8035A	MM CORE PROBE ACCESS COVER		0H8035A0	MM CORE PROBE ACCESS COVER																									
GN1632A	CORE PROBE INLET GASKET		KSN1050B	BIG-L L3200 SINGLE POINT CORE PROBE KIT	<table border="1"> <thead> <tr> <th>Code</th> <th>Description</th> <th>Qty</th> <th>UOM</th> </tr> </thead> <tbody> <tr> <td>0H7030A0</td> <td>THERMOSTAT BULB INLET COVER</td> <td>1.000</td> <td>PC</td> </tr> <tr> <td>GN1632A0</td> <td>CORE PROBE INLET GASKET</td> <td>1.000</td> <td>PC</td> </tr> <tr> <td>SL1045A0</td> <td>S57 BLACK SILICONE - 80ml CARTRIDGE</td> <td>1.000</td> <td>PC</td> </tr> <tr> <td>SN1050B0</td> <td>L3200 STRAIGHT MONO.POINT CORE PROBE</td> <td>1.000</td> <td>PC</td> </tr> <tr> <td>VI1220A1</td> <td>4,2x12 TCB SELF-TAPPIN G SCREW</td> <td>3.000</td> <td>PC</td> </tr> </tbody> </table>	Code	Description	Qty	UOM	0H7030A0	THERMOSTAT BULB INLET COVER	1.000	PC	GN1632A0	CORE PROBE INLET GASKET	1.000	PC	SL1045A0	S57 BLACK SILICONE - 80ml CARTRIDGE	1.000	PC	SN1050B0	L3200 STRAIGHT MONO.POINT CORE PROBE	1.000	PC	VI1220A1	4,2x12 TCB SELF-TAPPIN G SCREW	3.000	PC
Code	Description	Qty	UOM																										
0H7030A0	THERMOSTAT BULB INLET COVER	1.000	PC																										
GN1632A0	CORE PROBE INLET GASKET	1.000	PC																										
SL1045A0	S57 BLACK SILICONE - 80ml CARTRIDGE	1.000	PC																										
SN1050B0	L3200 STRAIGHT MONO.POINT CORE PROBE	1.000	PC																										
VI1220A1	4,2x12 TCB SELF-TAPPIN G SCREW	3.000	PC																										
			KSN1050A	SINGLE POINT CORE PROBE KIT L3200 BIG-L	<table border="1"> <thead> <tr> <th>Code</th> <th>Description</th> <th>Qty</th> <th>UOM</th> </tr> </thead> <tbody> <tr> <td>0H7030A0</td> <td>THERMOSTAT BULB INLET COVER</td> <td>1.000</td> <td>PC</td> </tr> <tr> <td>GN1632A0</td> <td>CORE PROBE INLET GASKET</td> <td>1.000</td> <td>PC</td> </tr> </tbody> </table>	Code	Description	Qty	UOM	0H7030A0	THERMOSTAT BULB INLET COVER	1.000	PC	GN1632A0	CORE PROBE INLET GASKET	1.000	PC												
Code	Description	Qty	UOM																										
0H7030A0	THERMOSTAT BULB INLET COVER	1.000	PC																										
GN1632A0	CORE PROBE INLET GASKET	1.000	PC																										



COMPONENT			SPARE PART																							
Code	Description	Image	Code	Description	Kit components																					
GN1632A	CORE PROBE INLET GASKET		KSN1050A	SINGLE POINT CORE PROBE KIT L3200 BIG-L	<table border="1"> <thead> <tr> <th>Code</th> <th>Description</th> <th>Qty</th> <th>UOM</th> </tr> </thead> <tbody> <tr> <td>SL1045A0</td> <td>S57 BLACK SILICONE - 80ml CARTRIDGE</td> <td>1.000</td> <td>PC</td> </tr> <tr> <td>SN1050A1</td> <td>L3200 PEEK MULTI.POINT CORE PROBE</td> <td>1.000</td> <td>PC</td> </tr> <tr> <td>VI1220A1</td> <td>4,2x12 TCB SELF-TAPPIN G SCREW</td> <td>3.000</td> <td>PC</td> </tr> </tbody> </table>	Code	Description	Qty	UOM	SL1045A0	S57 BLACK SILICONE - 80ml CARTRIDGE	1.000	PC	SN1050A1	L3200 PEEK MULTI.POINT CORE PROBE	1.000	PC	VI1220A1	4,2x12 TCB SELF-TAPPIN G SCREW	3.000	PC					
			Code	Description	Qty	UOM																				
			SL1045A0	S57 BLACK SILICONE - 80ml CARTRIDGE	1.000	PC																				
			SN1050A1	L3200 PEEK MULTI.POINT CORE PROBE	1.000	PC																				
VI1220A1	4,2x12 TCB SELF-TAPPIN G SCREW	3.000	PC																							
KSN1049B	MULTIPOINT CORE PROBE KIT L3200	<table border="1"> <thead> <tr> <th>Code</th> <th>Description</th> <th>Qty</th> <th>UOM</th> </tr> </thead> <tbody> <tr> <td>0H8035A0</td> <td>MM CORE PROBE ACCESS COVE</td> <td>1.000</td> <td>PC</td> </tr> <tr> <td>GN1632A0</td> <td>CORE PROBE INLET GASKET</td> <td>1.000</td> <td>PC</td> </tr> <tr> <td>SL1045A0</td> <td>S57 BLACK SILICONE - 80ml CARTRIDGE</td> <td>1.000</td> <td>PC</td> </tr> <tr> <td>SN1049B0</td> <td>L3200 STRAIGHT MULTI.POINT CORE PROBE</td> <td>1.000</td> <td>PC</td> </tr> <tr> <td>VI1220A1</td> <td>4,2x12 TCB SELF-TAPPIN G SCREW</td> <td>3.000</td> <td>PC</td> </tr> </tbody> </table>	Code	Description	Qty	UOM	0H8035A0	MM CORE PROBE ACCESS COVE	1.000	PC	GN1632A0	CORE PROBE INLET GASKET	1.000	PC	SL1045A0	S57 BLACK SILICONE - 80ml CARTRIDGE	1.000	PC	SN1049B0	L3200 STRAIGHT MULTI.POINT CORE PROBE	1.000	PC	VI1220A1	4,2x12 TCB SELF-TAPPIN G SCREW	3.000	PC
Code	Description	Qty	UOM																							
0H8035A0	MM CORE PROBE ACCESS COVE	1.000	PC																							
GN1632A0	CORE PROBE INLET GASKET	1.000	PC																							
SL1045A0	S57 BLACK SILICONE - 80ml CARTRIDGE	1.000	PC																							
SN1049B0	L3200 STRAIGHT MULTI.POINT CORE PROBE	1.000	PC																							
VI1220A1	4,2x12 TCB SELF-TAPPIN G SCREW	3.000	PC																							
KSN1032A	SINGLE POINT CORE PROBE KIT L2750	<table border="1"> <thead> <tr> <th>Code</th> <th>Description</th> <th>Qty</th> <th>UOM</th> </tr> </thead> <tbody> <tr> <td>0H7030A0</td> <td>THERMOSTAT BULB INLET COVER</td> <td>1.000</td> <td>PC</td> </tr> <tr> <td>GN1632A0</td> <td>CORE PROBE INLET GASKET</td> <td>1.000</td> <td>PC</td> </tr> <tr> <td>SL1045A0</td> <td>S57 BLACK SILICONE - 80ml CARTRIDGE</td> <td>1.000</td> <td>PC</td> </tr> <tr> <td>SN1032A0</td> <td>L2750 MULTI.Point CORE PROBE WITHOUT NUT</td> <td>1.000</td> <td>PC</td> </tr> <tr> <td>VI1220A1</td> <td>4,2x12 TCB SELF-TAPPIN G SCREW</td> <td>3.000</td> <td>PC</td> </tr> </tbody> </table>	Code	Description	Qty	UOM	0H7030A0	THERMOSTAT BULB INLET COVER	1.000	PC	GN1632A0	CORE PROBE INLET GASKET	1.000	PC	SL1045A0	S57 BLACK SILICONE - 80ml CARTRIDGE	1.000	PC	SN1032A0	L2750 MULTI.Point CORE PROBE WITHOUT NUT	1.000	PC	VI1220A1	4,2x12 TCB SELF-TAPPIN G SCREW	3.000	PC
Code	Description	Qty	UOM																							
0H7030A0	THERMOSTAT BULB INLET COVER	1.000	PC																							
GN1632A0	CORE PROBE INLET GASKET	1.000	PC																							
SL1045A0	S57 BLACK SILICONE - 80ml CARTRIDGE	1.000	PC																							
SN1032A0	L2750 MULTI.Point CORE PROBE WITHOUT NUT	1.000	PC																							
VI1220A1	4,2x12 TCB SELF-TAPPIN G SCREW	3.000	PC																							
KSN1031A	SINGLE POINT CORE PROBE KIT L2000	<table border="1"> <thead> <tr> <th>Code</th> <th>Description</th> <th>Qty</th> <th>UOM</th> </tr> </thead> <tbody> <tr> <td>0H7030A0</td> <td>THERMOSTAT BULB INLET COVER</td> <td>1.000</td> <td>PC</td> </tr> <tr> <td>GN1632A0</td> <td>CORE PROBE INLET GASKET</td> <td>1.000</td> <td>PC</td> </tr> </tbody> </table>	Code	Description	Qty	UOM	0H7030A0	THERMOSTAT BULB INLET COVER	1.000	PC	GN1632A0	CORE PROBE INLET GASKET	1.000	PC												
Code	Description	Qty	UOM																							
0H7030A0	THERMOSTAT BULB INLET COVER	1.000	PC																							
GN1632A0	CORE PROBE INLET GASKET	1.000	PC																							



COMPONENT			SPARE PART																																			
Code	Description	Image	Code	Description	Kit components																																	
GN1632A	CORE PROBE INLET GASKET		KSN1031A	SINGLE POINT CORE PROBE KIT L2000	<table border="1"> <thead> <tr> <th>Code</th> <th>Description</th> <th>Qty</th> <th>UOM</th> </tr> </thead> <tbody> <tr> <td>SL1045A0</td> <td>S57 BLACK SILICONE - 80ml CARTRIDGE</td> <td>1.000</td> <td>PC</td> </tr> <tr> <td>SN1031A1</td> <td></td> <td>1.000</td> <td>PC</td> </tr> <tr> <td>VI1220A1</td> <td>4,2x12 TCB SELF-TAPPIN G SCREW</td> <td>3.000</td> <td>PC</td> </tr> </tbody> </table>	Code	Description	Qty	UOM	SL1045A0	S57 BLACK SILICONE - 80ml CARTRIDGE	1.000	PC	SN1031A1		1.000	PC	VI1220A1	4,2x12 TCB SELF-TAPPIN G SCREW	3.000	PC																	
			Code	Description	Qty	UOM																																
			SL1045A0	S57 BLACK SILICONE - 80ml CARTRIDGE	1.000	PC																																
SN1031A1		1.000	PC																																			
VI1220A1	4,2x12 TCB SELF-TAPPIN G SCREW	3.000	PC																																			
KSN1030A	SINGLE POINT CORE PROBE KIT L1550	<table border="1"> <thead> <tr> <th>Code</th> <th>Description</th> <th>Qty</th> <th>UOM</th> </tr> </thead> <tbody> <tr> <td>0H7030A0</td> <td>THERMOSTAT BULB INLET COVER</td> <td>1.000</td> <td>PC</td> </tr> <tr> <td>GN1632A0</td> <td>CORE PROBE INLET GASKET</td> <td>1.000</td> <td>PC</td> </tr> <tr> <td>SL1045A0</td> <td>S57 BLACK SILICONE - 80ml CARTRIDGE</td> <td>1.000</td> <td>PC</td> </tr> <tr> <td>SN1030A1</td> <td>L1550 MONOPOINT CORE PROBE WITHOUT NUT</td> <td>1.000</td> <td>PC</td> </tr> <tr> <td>VI1220A1</td> <td>4,2x12 TCB SELF-TAPPIN G SCREW</td> <td>3.000</td> <td>PC</td> </tr> </tbody> </table>	Code	Description	Qty	UOM	0H7030A0	THERMOSTAT BULB INLET COVER	1.000	PC	GN1632A0	CORE PROBE INLET GASKET	1.000	PC	SL1045A0	S57 BLACK SILICONE - 80ml CARTRIDGE	1.000	PC	SN1030A1	L1550 MONOPOINT CORE PROBE WITHOUT NUT	1.000	PC	VI1220A1	4,2x12 TCB SELF-TAPPIN G SCREW	3.000	PC												
Code	Description	Qty	UOM																																			
0H7030A0	THERMOSTAT BULB INLET COVER	1.000	PC																																			
GN1632A0	CORE PROBE INLET GASKET	1.000	PC																																			
SL1045A0	S57 BLACK SILICONE - 80ml CARTRIDGE	1.000	PC																																			
SN1030A1	L1550 MONOPOINT CORE PROBE WITHOUT NUT	1.000	PC																																			
VI1220A1	4,2x12 TCB SELF-TAPPIN G SCREW	3.000	PC																																			
KSN1021B	US MULTI.POINT L2750 CORE PROBE KIT	<table border="1"> <thead> <tr> <th>Code</th> <th>Description</th> <th>Qty</th> <th>UOM</th> </tr> </thead> <tbody> <tr> <td>0H8035A0</td> <td>MM CORE PROBE ACCESS COVE</td> <td>1.000</td> <td>PC</td> </tr> <tr> <td>CE1037A0</td> <td>UL SILICONE GLASS FIBER SHEATH</td> <td>1.500</td> <td>M</td> </tr> <tr> <td>CE1685A0</td> <td>MRT8 P3,81 5 POLES FEMALE TERMINAL</td> <td>1.000</td> <td>PC</td> </tr> <tr> <td>GN1632A0</td> <td>CORE PROBE INLET GASKET</td> <td>1.000</td> <td>PC</td> </tr> <tr> <td>RC1130A0</td> <td>130x2,6 CLAM</td> <td>2.000</td> <td>PC</td> </tr> <tr> <td>SL1045A0</td> <td>S57 BLACK SILICONE - 80ml CARTRIDGE</td> <td>1.000</td> <td>PC</td> </tr> <tr> <td>SN1012B1</td> <td>L2750 MULTIPOINT CORE PROBE WITHOUT NUT</td> <td>1.000</td> <td>PC</td> </tr> <tr> <td>VI1220A1</td> <td>4,2x12 TCB SELF-TAPPIN G SCREW</td> <td>3.000</td> <td>PC</td> </tr> </tbody> </table>	Code	Description	Qty	UOM	0H8035A0	MM CORE PROBE ACCESS COVE	1.000	PC	CE1037A0	UL SILICONE GLASS FIBER SHEATH	1.500	M	CE1685A0	MRT8 P3,81 5 POLES FEMALE TERMINAL	1.000	PC	GN1632A0	CORE PROBE INLET GASKET	1.000	PC	RC1130A0	130x2,6 CLAM	2.000	PC	SL1045A0	S57 BLACK SILICONE - 80ml CARTRIDGE	1.000	PC	SN1012B1	L2750 MULTIPOINT CORE PROBE WITHOUT NUT	1.000	PC	VI1220A1	4,2x12 TCB SELF-TAPPIN G SCREW	3.000	PC
Code	Description	Qty	UOM																																			
0H8035A0	MM CORE PROBE ACCESS COVE	1.000	PC																																			
CE1037A0	UL SILICONE GLASS FIBER SHEATH	1.500	M																																			
CE1685A0	MRT8 P3,81 5 POLES FEMALE TERMINAL	1.000	PC																																			
GN1632A0	CORE PROBE INLET GASKET	1.000	PC																																			
RC1130A0	130x2,6 CLAM	2.000	PC																																			
SL1045A0	S57 BLACK SILICONE - 80ml CARTRIDGE	1.000	PC																																			
SN1012B1	L2750 MULTIPOINT CORE PROBE WITHOUT NUT	1.000	PC																																			
VI1220A1	4,2x12 TCB SELF-TAPPIN G SCREW	3.000	PC																																			







COMPONENT			SPARE PART																																						
Code	Description	Image	Code	Description	Kit components																																				
GN1632A	CORE PROBE INLET GASKET		KSN1020B	US MULTIPOINT L2050 CORE PROBE KIT	<table border="1"> <thead> <tr> <th>Code</th> <th>Description</th> <th>Qty</th> <th>UOM</th> </tr> </thead> <tbody> <tr> <td>0H8035A0</td> <td>MM CORE PROBE ACCESS COVE</td> <td>1.000</td> <td>PC</td> </tr> <tr> <td>CE1037A0</td> <td>UL SILICONE GLASS FIBER SHEATH</td> <td>0.700</td> <td>M</td> </tr> <tr> <td>CE1685A0</td> <td>MRT8 P3,81 5 POLES FEMALE TERMINAL</td> <td>1.000</td> <td>PC</td> </tr> <tr> <td>GN1632A0</td> <td>CORE PROBE INLET GASKET</td> <td>1.000</td> <td>PC</td> </tr> <tr> <td>RC1130A0</td> <td>130x2,6 CLAM</td> <td>2.000</td> <td>PC</td> </tr> <tr> <td>SL1045A0</td> <td>S57 BLACK SILICONE - 80ml CARTRIDGE</td> <td>1.000</td> <td>PC</td> </tr> <tr> <td>SN1002B1</td> <td>L2050 MULTIPOINT CORE PROBE WITHOUT NUT</td> <td>1.000</td> <td>PC</td> </tr> <tr> <td>VI1220A1</td> <td>4,2x12 TCB SELF-TAPPIN G SCREW</td> <td>3.000</td> <td>PC</td> </tr> </tbody> </table>	Code	Description	Qty	UOM	0H8035A0	MM CORE PROBE ACCESS COVE	1.000	PC	CE1037A0	UL SILICONE GLASS FIBER SHEATH	0.700	M	CE1685A0	MRT8 P3,81 5 POLES FEMALE TERMINAL	1.000	PC	GN1632A0	CORE PROBE INLET GASKET	1.000	PC	RC1130A0	130x2,6 CLAM	2.000	PC	SL1045A0	S57 BLACK SILICONE - 80ml CARTRIDGE	1.000	PC	SN1002B1	L2050 MULTIPOINT CORE PROBE WITHOUT NUT	1.000	PC	VI1220A1	4,2x12 TCB SELF-TAPPIN G SCREW	3.000	PC
			Code	Description	Qty	UOM																																			
			0H8035A0	MM CORE PROBE ACCESS COVE	1.000	PC																																			
CE1037A0	UL SILICONE GLASS FIBER SHEATH	0.700	M																																						
CE1685A0	MRT8 P3,81 5 POLES FEMALE TERMINAL	1.000	PC																																						
GN1632A0	CORE PROBE INLET GASKET	1.000	PC																																						
RC1130A0	130x2,6 CLAM	2.000	PC																																						
SL1045A0	S57 BLACK SILICONE - 80ml CARTRIDGE	1.000	PC																																						
SN1002B1	L2050 MULTIPOINT CORE PROBE WITHOUT NUT	1.000	PC																																						
VI1220A1	4,2x12 TCB SELF-TAPPIN G SCREW	3.000	PC																																						
KSN1019B	US MULTIPOINT L1550 CORE PROBE KIT	<table border="1"> <thead> <tr> <th>Code</th> <th>Description</th> <th>Qty</th> <th>UOM</th> </tr> </thead> <tbody> <tr> <td>0H8035A0</td> <td>MM CORE PROBE ACCESS COVE</td> <td>1.000</td> <td>PC</td> </tr> <tr> <td>CE1037A0</td> <td>UL SILICONE GLASS FIBER SHEATH</td> <td>0.600</td> <td>M</td> </tr> <tr> <td>CE1685A0</td> <td>MRT8 P3,81 5 POLES FEMALE TERMINAL</td> <td>1.000</td> <td>PC</td> </tr> <tr> <td>GN1632A0</td> <td>CORE PROBE INLET GASKET</td> <td>1.000</td> <td>PC</td> </tr> <tr> <td>RC1130A0</td> <td>130x2,6 CLAM</td> <td>2.000</td> <td>PC</td> </tr> <tr> <td>SL1045A0</td> <td>S57 BLACK SILICONE - 80ml CARTRIDGE</td> <td>1.000</td> <td>PC</td> </tr> <tr> <td>SN1000B1</td> <td>L1550 MULTIPOINT CORE PROBE WITHOUT NUT</td> <td>1.000</td> <td>PC</td> </tr> <tr> <td>VI1220A1</td> <td>4,2x12 TCB SELF-TAPPIN G SCREW</td> <td>3.000</td> <td>PC</td> </tr> </tbody> </table>	Code	Description	Qty	UOM	0H8035A0	MM CORE PROBE ACCESS COVE	1.000	PC	CE1037A0	UL SILICONE GLASS FIBER SHEATH	0.600	M	CE1685A0	MRT8 P3,81 5 POLES FEMALE TERMINAL	1.000	PC	GN1632A0	CORE PROBE INLET GASKET	1.000	PC	RC1130A0	130x2,6 CLAM	2.000	PC	SL1045A0	S57 BLACK SILICONE - 80ml CARTRIDGE	1.000	PC	SN1000B1	L1550 MULTIPOINT CORE PROBE WITHOUT NUT	1.000	PC	VI1220A1	4,2x12 TCB SELF-TAPPIN G SCREW	3.000	PC			
Code	Description	Qty	UOM																																						
0H8035A0	MM CORE PROBE ACCESS COVE	1.000	PC																																						
CE1037A0	UL SILICONE GLASS FIBER SHEATH	0.600	M																																						
CE1685A0	MRT8 P3,81 5 POLES FEMALE TERMINAL	1.000	PC																																						
GN1632A0	CORE PROBE INLET GASKET	1.000	PC																																						
RC1130A0	130x2,6 CLAM	2.000	PC																																						
SL1045A0	S57 BLACK SILICONE - 80ml CARTRIDGE	1.000	PC																																						
SN1000B1	L1550 MULTIPOINT CORE PROBE WITHOUT NUT	1.000	PC																																						
VI1220A1	4,2x12 TCB SELF-TAPPIN G SCREW	3.000	PC																																						
KSN1012B	MULTIPOINT CORE PROBE KIT L2750	<table border="1"> <thead> <tr> <th>Code</th> <th>Description</th> <th>Qty</th> <th>UOM</th> </tr> </thead> <tbody> <tr> <td>0H8035A0</td> <td>MM CORE PROBE ACCESS COVE</td> <td>1.000</td> <td>PC</td> </tr> </tbody> </table>	Code	Description	Qty	UOM	0H8035A0	MM CORE PROBE ACCESS COVE	1.000	PC																															
Code	Description	Qty	UOM																																						
0H8035A0	MM CORE PROBE ACCESS COVE	1.000	PC																																						



COMPONENT			SPARE PART																											
Code	Description	Image	Code	Description	Kit components																									
GN1632A	CORE PROBE INLET GASKET		KSN1012B	MULTIPOINT CORE PROBE KIT L2750	<table border="1"> <thead> <tr> <th>Code</th> <th>Description</th> <th>Qty</th> <th>UOM</th> </tr> </thead> <tbody> <tr> <td>CE1685A0</td> <td>MRT8 P3,81 5 POLES FEMALE TERMINAL</td> <td>1.000</td> <td>PC</td> </tr> <tr> <td>GN1632A0</td> <td>CORE PROBE INLET GASKET</td> <td>1.000</td> <td>PC</td> </tr> <tr> <td>SL1045A0</td> <td>S57 BLACK SILICONE - 80ml CARTRIDGE</td> <td>1.000</td> <td>PC</td> </tr> <tr> <td>SN1012B1</td> <td>L2750 MULTIPOINT CORE PROBE WITHOUT NUT</td> <td>1.000</td> <td>PC</td> </tr> <tr> <td>VI1220A1</td> <td>4,2x12 TCB SELF-TAPPIN G SCREW</td> <td>3.000</td> <td>PC</td> </tr> </tbody> </table>	Code	Description	Qty	UOM	CE1685A0	MRT8 P3,81 5 POLES FEMALE TERMINAL	1.000	PC	GN1632A0	CORE PROBE INLET GASKET	1.000	PC	SL1045A0	S57 BLACK SILICONE - 80ml CARTRIDGE	1.000	PC	SN1012B1	L2750 MULTIPOINT CORE PROBE WITHOUT NUT	1.000	PC	VI1220A1	4,2x12 TCB SELF-TAPPIN G SCREW	3.000	PC	
			Code	Description	Qty	UOM																								
			CE1685A0	MRT8 P3,81 5 POLES FEMALE TERMINAL	1.000	PC																								
GN1632A0	CORE PROBE INLET GASKET	1.000	PC																											
SL1045A0	S57 BLACK SILICONE - 80ml CARTRIDGE	1.000	PC																											
SN1012B1	L2750 MULTIPOINT CORE PROBE WITHOUT NUT	1.000	PC																											
VI1220A1	4,2x12 TCB SELF-TAPPIN G SCREW	3.000	PC																											
KSN1002B	MULTIPOINT CORE PROBE KIT L2050	<table border="1"> <thead> <tr> <th>Code</th> <th>Description</th> <th>Qty</th> <th>UOM</th> </tr> </thead> <tbody> <tr> <td>0H8035A0</td> <td>MM CORE PROBE ACCESS COVE</td> <td>1.000</td> <td>PC</td> </tr> <tr> <td>CE1685A0</td> <td>MRT8 P3,81 5 POLES FEMALE TERMINAL</td> <td>1.000</td> <td>PC</td> </tr> <tr> <td>GN1632A0</td> <td>CORE PROBE INLET GASKET</td> <td>1.000</td> <td>PC</td> </tr> <tr> <td>SL1045A0</td> <td>S57 BLACK SILICONE - 80ml CARTRIDGE</td> <td>1.000</td> <td>PC</td> </tr> <tr> <td>SN1002B1</td> <td>L2050 MULTIPOINT CORE PROBE WITHOUT NUT</td> <td>1.000</td> <td>PC</td> </tr> <tr> <td>VI1220A1</td> <td>4,2x12 TCB SELF-TAPPIN G SCREW</td> <td>3.000</td> <td>PC</td> </tr> </tbody> </table>	Code	Description	Qty	UOM	0H8035A0	MM CORE PROBE ACCESS COVE	1.000	PC	CE1685A0	MRT8 P3,81 5 POLES FEMALE TERMINAL	1.000	PC	GN1632A0	CORE PROBE INLET GASKET	1.000	PC	SL1045A0	S57 BLACK SILICONE - 80ml CARTRIDGE	1.000	PC	SN1002B1	L2050 MULTIPOINT CORE PROBE WITHOUT NUT	1.000	PC	VI1220A1	4,2x12 TCB SELF-TAPPIN G SCREW	3.000	PC
Code	Description	Qty	UOM																											
0H8035A0	MM CORE PROBE ACCESS COVE	1.000	PC																											
CE1685A0	MRT8 P3,81 5 POLES FEMALE TERMINAL	1.000	PC																											
GN1632A0	CORE PROBE INLET GASKET	1.000	PC																											
SL1045A0	S57 BLACK SILICONE - 80ml CARTRIDGE	1.000	PC																											
SN1002B1	L2050 MULTIPOINT CORE PROBE WITHOUT NUT	1.000	PC																											
VI1220A1	4,2x12 TCB SELF-TAPPIN G SCREW	3.000	PC																											
KSN1000B	MULTIPOINT CORE PROBE KIT L1550	<table border="1"> <thead> <tr> <th>Code</th> <th>Description</th> <th>Qty</th> <th>UOM</th> </tr> </thead> <tbody> <tr> <td>0H8035A0</td> <td>MM CORE PROBE ACCESS COVE</td> <td>1.000</td> <td>PC</td> </tr> <tr> <td>CE1685A0</td> <td>MRT8 P3,81 5 POLES FEMALE TERMINAL</td> <td>1.000</td> <td>PC</td> </tr> <tr> <td>GN1632A0</td> <td>CORE PROBE INLET GASKET</td> <td>1.000</td> <td>PC</td> </tr> <tr> <td>SL1045A0</td> <td>S57 BLACK SILICONE - 80ml CARTRIDGE</td> <td>1.000</td> <td>PC</td> </tr> </tbody> </table>	Code	Description	Qty	UOM	0H8035A0	MM CORE PROBE ACCESS COVE	1.000	PC	CE1685A0	MRT8 P3,81 5 POLES FEMALE TERMINAL	1.000	PC	GN1632A0	CORE PROBE INLET GASKET	1.000	PC	SL1045A0	S57 BLACK SILICONE - 80ml CARTRIDGE	1.000	PC								
Code	Description	Qty	UOM																											
0H8035A0	MM CORE PROBE ACCESS COVE	1.000	PC																											
CE1685A0	MRT8 P3,81 5 POLES FEMALE TERMINAL	1.000	PC																											
GN1632A0	CORE PROBE INLET GASKET	1.000	PC																											
SL1045A0	S57 BLACK SILICONE - 80ml CARTRIDGE	1.000	PC																											



COMPONENT			SPARE PART																																						
Code	Description	Image	Code	Description	Kit components																																				
GN1632A	CORE PROBE INLET GASKET		KSN1000B	MULTIPOINT CORE PROBE KIT L1550	<table border="1"> <thead> <tr> <th>Code</th> <th>Description</th> <th>Qty</th> <th>UOM</th> </tr> </thead> <tbody> <tr> <td>SN1000B1</td> <td>L1550 MULTIPOINT CORE PROBE WITHOUT NUT</td> <td>1.000</td> <td>PC</td> </tr> <tr> <td>V11220A1</td> <td>4,2x12 TCB SELF-TAPPIN G SCREW</td> <td>3.000</td> <td>PC</td> </tr> </tbody> </table>	Code	Description	Qty	UOM	SN1000B1	L1550 MULTIPOINT CORE PROBE WITHOUT NUT	1.000	PC	V11220A1	4,2x12 TCB SELF-TAPPIN G SCREW	3.000	PC																								
					Code	Description	Qty	UOM																																	
SN1000B1	L1550 MULTIPOINT CORE PROBE WITHOUT NUT	1.000	PC																																						
V11220A1	4,2x12 TCB SELF-TAPPIN G SCREW	3.000	PC																																						
<table border="1"> <thead> <tr> <th>Code</th> <th>Description</th> <th>Qty</th> <th>UOM</th> </tr> </thead> <tbody> <tr> <td>0H8035A0</td> <td>MM CORE PROBE ACCESS COVE</td> <td>1.000</td> <td>PC</td> </tr> <tr> <td>CE1037A0</td> <td>UL SILICONE GLASS FIBER SHEATH</td> <td>0.700</td> <td>M</td> </tr> <tr> <td>CE1685A0</td> <td>MRT8 P3,81 5 POLES FEMALE TERMINAL</td> <td>1.000</td> <td>PC</td> </tr> <tr> <td>GN1632A0</td> <td>CORE PROBE INLET GASKET</td> <td>1.000</td> <td>PC</td> </tr> <tr> <td>RC1130A0</td> <td>130x2,6 CLAM</td> <td>2.000</td> <td>PC</td> </tr> <tr> <td>SL1045A0</td> <td>S57 BLACK SILICONE - 80ml CARTRIDGE</td> <td>1.000</td> <td>PC</td> </tr> <tr> <td>SN1002B1</td> <td>L2050 MULTIPOINT CORE PROBE WITHOUT NUT</td> <td>1.000</td> <td>PC</td> </tr> <tr> <td>V11220A1</td> <td>4,2x12 TCB SELF-TAPPIN G SCREW</td> <td>3.000</td> <td>PC</td> </tr> </tbody> </table>	Code	Description	Qty	UOM	0H8035A0	MM CORE PROBE ACCESS COVE	1.000	PC	CE1037A0	UL SILICONE GLASS FIBER SHEATH	0.700	M	CE1685A0	MRT8 P3,81 5 POLES FEMALE TERMINAL	1.000	PC	GN1632A0	CORE PROBE INLET GASKET	1.000	PC	RC1130A0	130x2,6 CLAM	2.000	PC	SL1045A0	S57 BLACK SILICONE - 80ml CARTRIDGE	1.000	PC	SN1002B1	L2050 MULTIPOINT CORE PROBE WITHOUT NUT	1.000	PC	V11220A1	4,2x12 TCB SELF-TAPPIN G SCREW	3.000	PC					
Code	Description	Qty	UOM																																						
0H8035A0	MM CORE PROBE ACCESS COVE	1.000	PC																																						
CE1037A0	UL SILICONE GLASS FIBER SHEATH	0.700	M																																						
CE1685A0	MRT8 P3,81 5 POLES FEMALE TERMINAL	1.000	PC																																						
GN1632A0	CORE PROBE INLET GASKET	1.000	PC																																						
RC1130A0	130x2,6 CLAM	2.000	PC																																						
SL1045A0	S57 BLACK SILICONE - 80ml CARTRIDGE	1.000	PC																																						
SN1002B1	L2050 MULTIPOINT CORE PROBE WITHOUT NUT	1.000	PC																																						
V11220A1	4,2x12 TCB SELF-TAPPIN G SCREW	3.000	PC																																						
SN1002B	L2050 MULTIPOINT CORE PROBE WITHOUT NUT		KSN1020B	US MULTIPOINT L2050 CORE PROBE KIT	<table border="1"> <thead> <tr> <th>Code</th> <th>Description</th> <th>Qty</th> <th>UOM</th> </tr> </thead> <tbody> <tr> <td>0H8035A0</td> <td>MM CORE PROBE ACCESS COVE</td> <td>1.000</td> <td>PC</td> </tr> <tr> <td>CE1037A0</td> <td>UL SILICONE GLASS FIBER SHEATH</td> <td>0.700</td> <td>M</td> </tr> <tr> <td>CE1685A0</td> <td>MRT8 P3,81 5 POLES FEMALE TERMINAL</td> <td>1.000</td> <td>PC</td> </tr> <tr> <td>GN1632A0</td> <td>CORE PROBE INLET GASKET</td> <td>1.000</td> <td>PC</td> </tr> <tr> <td>RC1130A0</td> <td>130x2,6 CLAM</td> <td>2.000</td> <td>PC</td> </tr> <tr> <td>SL1045A0</td> <td>S57 BLACK SILICONE - 80ml CARTRIDGE</td> <td>1.000</td> <td>PC</td> </tr> <tr> <td>SN1002B1</td> <td>L2050 MULTIPOINT CORE PROBE WITHOUT NUT</td> <td>1.000</td> <td>PC</td> </tr> <tr> <td>V11220A1</td> <td>4,2x12 TCB SELF-TAPPIN G SCREW</td> <td>3.000</td> <td>PC</td> </tr> </tbody> </table>	Code	Description	Qty	UOM	0H8035A0	MM CORE PROBE ACCESS COVE	1.000	PC	CE1037A0	UL SILICONE GLASS FIBER SHEATH	0.700	M	CE1685A0	MRT8 P3,81 5 POLES FEMALE TERMINAL	1.000	PC	GN1632A0	CORE PROBE INLET GASKET	1.000	PC	RC1130A0	130x2,6 CLAM	2.000	PC	SL1045A0	S57 BLACK SILICONE - 80ml CARTRIDGE	1.000	PC	SN1002B1	L2050 MULTIPOINT CORE PROBE WITHOUT NUT	1.000	PC	V11220A1	4,2x12 TCB SELF-TAPPIN G SCREW	3.000	PC
			Code	Description	Qty	UOM																																			
0H8035A0	MM CORE PROBE ACCESS COVE	1.000	PC																																						
CE1037A0	UL SILICONE GLASS FIBER SHEATH	0.700	M																																						
CE1685A0	MRT8 P3,81 5 POLES FEMALE TERMINAL	1.000	PC																																						
GN1632A0	CORE PROBE INLET GASKET	1.000	PC																																						
RC1130A0	130x2,6 CLAM	2.000	PC																																						
SL1045A0	S57 BLACK SILICONE - 80ml CARTRIDGE	1.000	PC																																						
SN1002B1	L2050 MULTIPOINT CORE PROBE WITHOUT NUT	1.000	PC																																						
V11220A1	4,2x12 TCB SELF-TAPPIN G SCREW	3.000	PC																																						
<table border="1"> <thead> <tr> <th>Code</th> <th>Description</th> <th>Qty</th> <th>UOM</th> </tr> </thead> <tbody> <tr> <td>0H8035A0</td> <td>MM CORE PROBE ACCESS COVE</td> <td>1.000</td> <td>PC</td> </tr> <tr> <td>CE1685A0</td> <td>MRT8 P3,81 5 POLES FEMALE TERMINAL</td> <td>1.000</td> <td>PC</td> </tr> <tr> <td>GN1632A0</td> <td>CORE PROBE INLET GASKET</td> <td>1.000</td> <td>PC</td> </tr> <tr> <td>SL1045A0</td> <td>S57 BLACK SILICONE - 80ml CARTRIDGE</td> <td>1.000</td> <td>PC</td> </tr> <tr> <td>SN1002B1</td> <td>L2050 MULTIPOINT CORE PROBE WITHOUT NUT</td> <td>1.000</td> <td>PC</td> </tr> <tr> <td>V11220A1</td> <td>4,2x12 TCB SELF-TAPPIN G SCREW</td> <td>3.000</td> <td>PC</td> </tr> </tbody> </table>	Code	Description	Qty	UOM	0H8035A0	MM CORE PROBE ACCESS COVE	1.000	PC	CE1685A0	MRT8 P3,81 5 POLES FEMALE TERMINAL	1.000	PC	GN1632A0	CORE PROBE INLET GASKET	1.000	PC	SL1045A0	S57 BLACK SILICONE - 80ml CARTRIDGE	1.000	PC	SN1002B1	L2050 MULTIPOINT CORE PROBE WITHOUT NUT	1.000	PC	V11220A1	4,2x12 TCB SELF-TAPPIN G SCREW	3.000	PC													
Code	Description	Qty	UOM																																						
0H8035A0	MM CORE PROBE ACCESS COVE	1.000	PC																																						
CE1685A0	MRT8 P3,81 5 POLES FEMALE TERMINAL	1.000	PC																																						
GN1632A0	CORE PROBE INLET GASKET	1.000	PC																																						
SL1045A0	S57 BLACK SILICONE - 80ml CARTRIDGE	1.000	PC																																						
SN1002B1	L2050 MULTIPOINT CORE PROBE WITHOUT NUT	1.000	PC																																						
V11220A1	4,2x12 TCB SELF-TAPPIN G SCREW	3.000	PC																																						

COMPONENT			SPARE PART																					
Code	Description	Image	Code	Description	Kit components																			
GN1658A	GN1626A- XEBC-04EU GASKET MM		KGN1658A	XEBC-04XX DOOR GASKET KIT	<table border="1"> <thead> <tr> <th>Code</th> <th>Description</th> <th>Qty</th> <th>UOM</th> </tr> </thead> <tbody> <tr> <td>GN1626A0</td> <td>DOUBLE LIP-TYPE FRONT GASKE</td> <td>2.210</td> <td>M</td> </tr> <tr> <td>SL1025A0</td> <td>CLEAR SILICON DOW CORNING 734</td> <td>0.012</td> <td>PC</td> </tr> <tr> <td>VM2277A0</td> <td>DOOR SEAL KIT INTERNAL CONNECTION</td> <td>1.000</td> <td>PC</td> </tr> </tbody> </table>	Code	Description	Qty	UOM	GN1626A0	DOUBLE LIP-TYPE FRONT GASKE	2.210	M	SL1025A0	CLEAR SILICON DOW CORNING 734	0.012	PC	VM2277A0	DOOR SEAL KIT INTERNAL CONNECTION	1.000	PC			
Code	Description	Qty	UOM																					
GN1626A0	DOUBLE LIP-TYPE FRONT GASKE	2.210	M																					
SL1025A0	CLEAR SILICON DOW CORNING 734	0.012	PC																					
VM2277A0	DOOR SEAL KIT INTERNAL CONNECTION	1.000	PC																					
RC1378A	HOSE CLAMP		KVM2379A	MM 200V VENTURI ACTUATOR SYSTEM KIT	<table border="1"> <thead> <tr> <th>Code</th> <th>Description</th> <th>Qty</th> <th>UOM</th> </tr> </thead> <tbody> <tr> <td>RC1378A0</td> <td>HOSE CLAMP</td> <td>3.000</td> <td>PC</td> </tr> <tr> <td>TB1520A0</td> <td>Int. Ø=38 TH=4 DRAIN BLACK RUBBER PIPE</td> <td>0.120</td> <td>M</td> </tr> <tr> <td>VM2379A1</td> <td></td> <td>1.000</td> <td>PC</td> </tr> </tbody> </table>	Code	Description	Qty	UOM	RC1378A0	HOSE CLAMP	3.000	PC	TB1520A0	Int. Ø=38 TH=4 DRAIN BLACK RUBBER PIPE	0.120	M	VM2379A1		1.000	PC			
Code	Description	Qty	UOM																					
RC1378A0	HOSE CLAMP	3.000	PC																					
TB1520A0	Int. Ø=38 TH=4 DRAIN BLACK RUBBER PIPE	0.120	M																					
VM2379A1		1.000	PC																					
KVM2378A	MM 240V VENTURI ACTUATOR SYSTEM KIT	KVE1140A	S.5/5E JAPAN VERSION VENTURI COIL KIT	<table border="1"> <thead> <tr> <th>Code</th> <th>Description</th> <th>Qty</th> <th>UOM</th> </tr> </thead> <tbody> <tr> <td>RC1378A0</td> <td>HOSE CLAMP</td> <td>3.000</td> <td>PC</td> </tr> <tr> <td>TB1520A0</td> <td>Int. Ø=38 TH=4 DRAIN BLACK RUBBER PIPE</td> <td>0.120</td> <td>M</td> </tr> <tr> <td>VM2378A1</td> <td></td> <td>1.000</td> <td>PC</td> </tr> </tbody> </table>	Code	Description	Qty	UOM	RC1378A0	HOSE CLAMP	3.000	PC	TB1520A0	Int. Ø=38 TH=4 DRAIN BLACK RUBBER PIPE	0.120	M	VM2378A1		1.000	PC				
Code	Description	Qty	UOM																					
RC1378A0	HOSE CLAMP	3.000	PC																					
TB1520A0	Int. Ø=38 TH=4 DRAIN BLACK RUBBER PIPE	0.120	M																					
VM2378A1		1.000	PC																					
KVM2377A	MM 220 V VENTURI ACTUATOR SYSTEM KIT	KVE1014A	US VERSION SERIES 5 VENTURI COIL KIT	<table border="1"> <thead> <tr> <th>Code</th> <th>Description</th> <th>Qty</th> <th>UOM</th> </tr> </thead> <tbody> <tr> <td>RC1378A0</td> <td>HOSE CLAMP</td> <td>3.000</td> <td>PC</td> </tr> <tr> <td>TB1520A0</td> <td>Int. Ø=38 TH=4 DRAIN BLACK RUBBER PIPE</td> <td>0.120</td> <td>M</td> </tr> <tr> <td>VM2377A1</td> <td>220 V 50/60 HZ EUR VENTURI SET</td> <td>1.000</td> <td>PC</td> </tr> </tbody> </table>	Code	Description	Qty	UOM	RC1378A0	HOSE CLAMP	3.000	PC	TB1520A0	Int. Ø=38 TH=4 DRAIN BLACK RUBBER PIPE	0.120	M	VM2377A1	220 V 50/60 HZ EUR VENTURI SET	1.000	PC				
Code	Description	Qty	UOM																					
RC1378A0	HOSE CLAMP	3.000	PC																					
TB1520A0	Int. Ø=38 TH=4 DRAIN BLACK RUBBER PIPE	0.120	M																					
VM2377A1	220 V 50/60 HZ EUR VENTURI SET	1.000	PC																					
KRC1378A	HOSE CLAMP 10 PCS KIT			<table border="1"> <thead> <tr> <th>Code</th> <th>Description</th> <th>Qty</th> <th>UOM</th> </tr> </thead> <tbody> <tr> <td>RC1378A0</td> <td>HOSE CLAMP</td> <td>2.000</td> <td>PC</td> </tr> <tr> <td>TB1520A0</td> <td>Int. Ø=38 TH=4 DRAIN BLACK RUBBER PIPE</td> <td>0.050</td> <td>M</td> </tr> <tr> <td>VM2632A0</td> <td></td> <td>1.000</td> <td>PC</td> </tr> <tr> <td>VM2633A0</td> <td></td> <td>1.000</td> <td>PC</td> </tr> </tbody> </table>	Code	Description	Qty	UOM	RC1378A0	HOSE CLAMP	2.000	PC	TB1520A0	Int. Ø=38 TH=4 DRAIN BLACK RUBBER PIPE	0.050	M	VM2632A0		1.000	PC	VM2633A0		1.000	PC
Code	Description	Qty	UOM																					
RC1378A0	HOSE CLAMP	2.000	PC																					
TB1520A0	Int. Ø=38 TH=4 DRAIN BLACK RUBBER PIPE	0.050	M																					
VM2632A0		1.000	PC																					
VM2633A0		1.000	PC																					
KRC1378A	HOSE CLAMP 10 PCS KIT			<table border="1"> <thead> <tr> <th>Code</th> <th>Description</th> <th>Qty</th> <th>UOM</th> </tr> </thead> <tbody> <tr> <td>RC1378A0</td> <td>HOSE CLAMP</td> <td>10.000</td> <td>PC</td> </tr> </tbody> </table>	Code	Description	Qty	UOM	RC1378A0	HOSE CLAMP	10.000	PC												
Code	Description	Qty	UOM																					
RC1378A0	HOSE CLAMP	10.000	PC																					



COMPONENT			SPARE PART										
Code	Description	Image	Code	Description	Kit components								
TB1389A	TB1520A-VENTURI PIPE FAN XEBC-04		TB1389A0	TB1520A-VENTURI PIPE FAN XEBC-04									
TB3033A	XEBC-10 CHAMBER CHIMNEY PIPE D50		TB3033A0	XEBC-10 CHAMBER CHIMNEY PIPE D50									
VL1037A	WASHING SYSTEM ROTOR ARM		KVL1037A	WASHING SYSTEM ROTOR ARM KIT	<table border="1"> <thead> <tr> <th>Code</th> <th>Description</th> <th>Qty</th> <th>UOM</th> </tr> </thead> <tbody> <tr> <td>VL1037A3</td> <td>WASHING SYSTEM ROTOR ARM</td> <td>1.000</td> <td>PC</td> </tr> </tbody> </table>	Code	Description	Qty	UOM	VL1037A3	WASHING SYSTEM ROTOR ARM	1.000	PC
Code	Description	Qty	UOM										
VL1037A3	WASHING SYSTEM ROTOR ARM	1.000	PC										
VM1820A	LATERAL SUPPORTS M6 FIXING BOLT		KVM1820A	THUMB SCREW 10PCS KIT	<table border="1"> <thead> <tr> <th>Code</th> <th>Description</th> <th>Qty</th> <th>UOM</th> </tr> </thead> <tbody> <tr> <td>VM1820A0</td> <td>LATERAL SUPPORTS M6 FIXING BOLT</td> <td>10.000</td> <td>PC</td> </tr> </tbody> </table>	Code	Description	Qty	UOM	VM1820A0	LATERAL SUPPORTS M6 FIXING BOLT	10.000	PC
Code	Description	Qty	UOM										
VM1820A0	LATERAL SUPPORTS M6 FIXING BOLT	10.000	PC										
VM2331A	FAN GUARD-TRAYS HOLDER PIN		KVM2331A	FAN GUARD-TRAYS HOLDER PIN 4 PCS KIT	<table border="1"> <thead> <tr> <th>Code</th> <th>Description</th> <th>Qty</th> <th>UOM</th> </tr> </thead> <tbody> <tr> <td>VM2331A0</td> <td>FAN GUARD-TRAY S HOLDER PIN</td> <td>4.000</td> <td>PC</td> </tr> </tbody> </table>	Code	Description	Qty	UOM	VM2331A0	FAN GUARD-TRAY S HOLDER PIN	4.000	PC
Code	Description	Qty	UOM										
VM2331A0	FAN GUARD-TRAY S HOLDER PIN	4.000	PC										



ASM1770C/0.D02 - External cover - FRONT

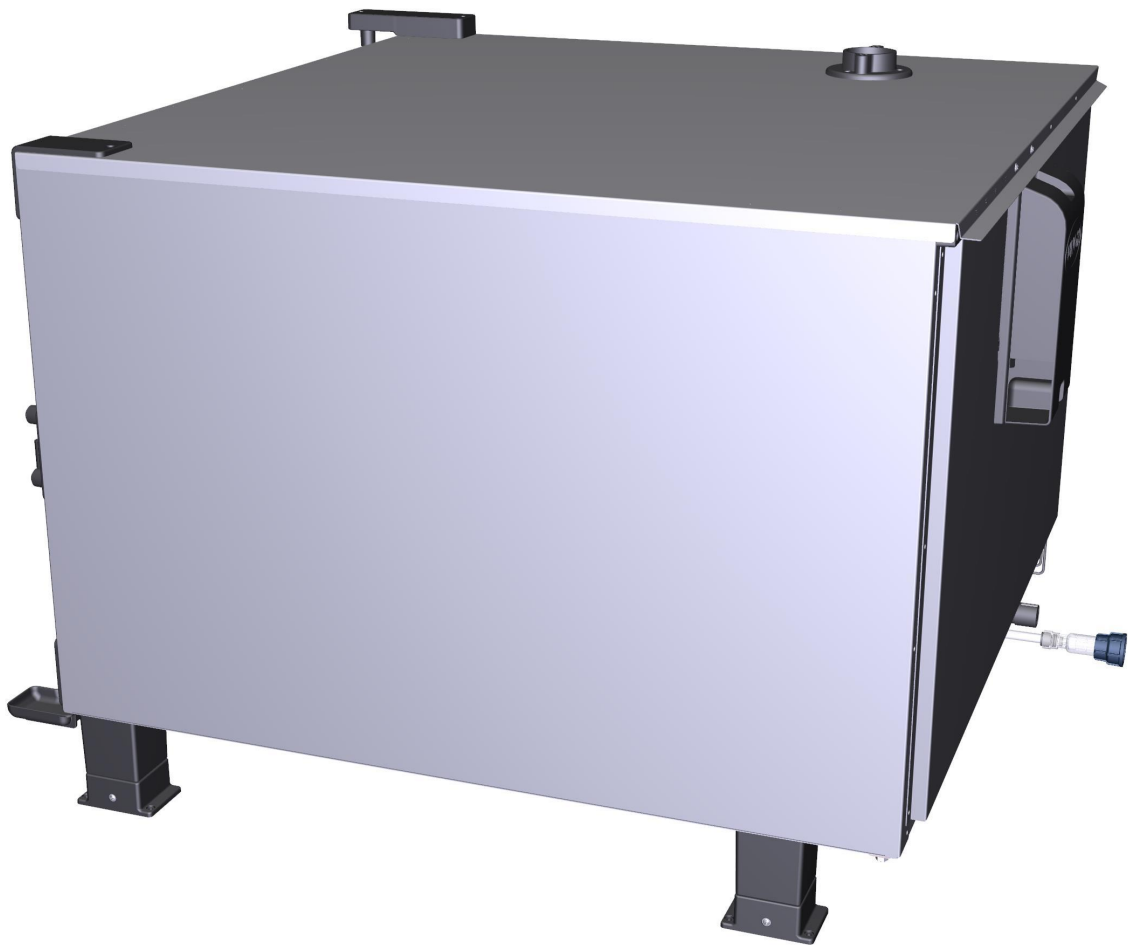





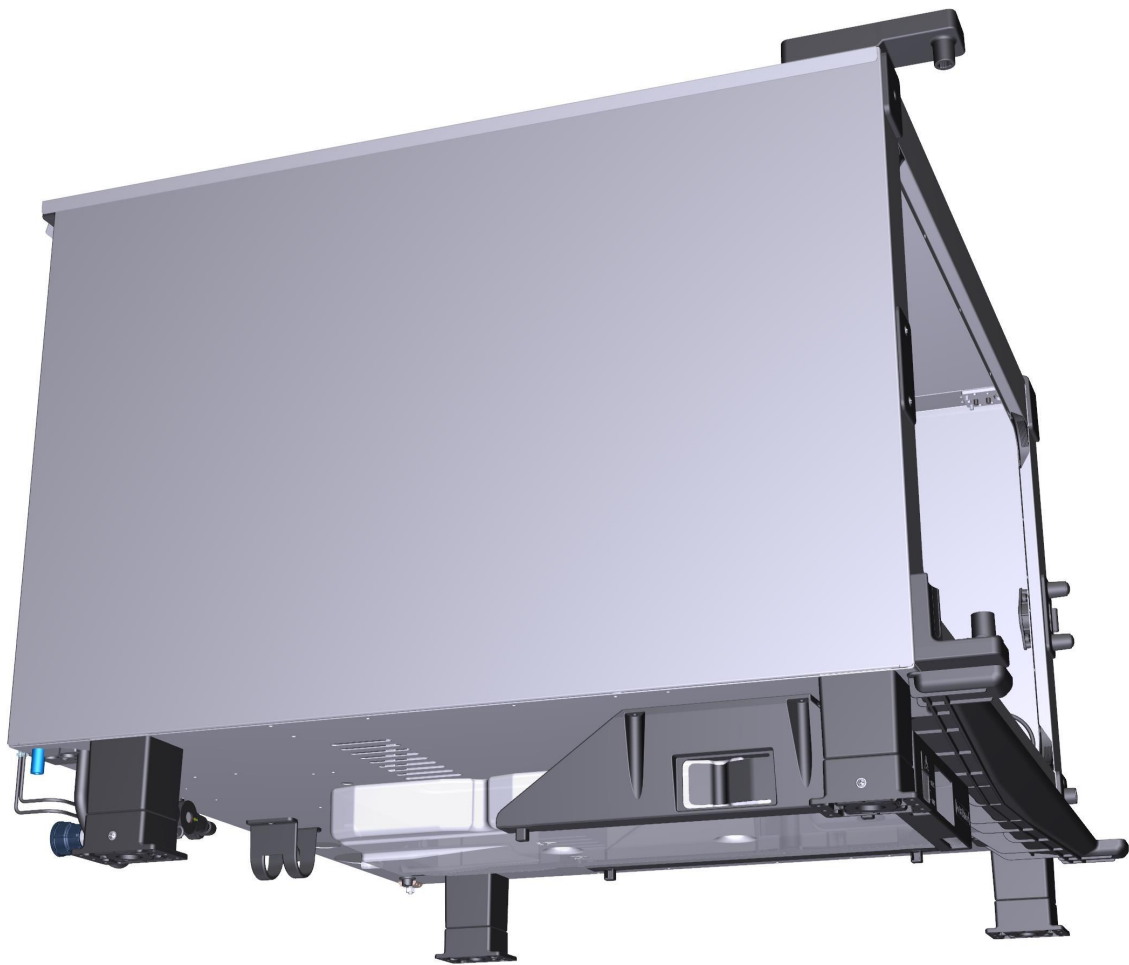



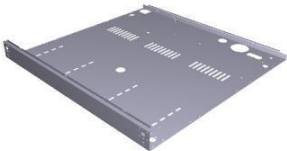

ASM1770C/0.D02 - External cover - REAR



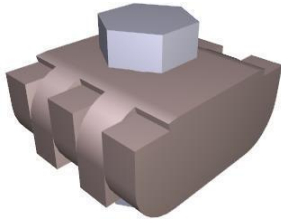

COMPONENT			SPARE PART		
Code	Description	Image	Code	Description	Kit components
0D2305B	XEBC-04EU-E EXTERNAL TOP COVER		0D2305B1	XEBC-04EU-E EXTERNAL TOP COVER	
0D2306A	XEBC-04EU-E LEFT SIDE PANEL		0D2306A1	XEBC-04EU-E LEFT SIDE PANEL	
0D2307A	XEBC-04EU-E RIGHT SIDE PANEL		0D2307A1	XEBC-04EU-E RIGHT SIDE PANEL	
0E1351C	XEBC EXTERNAL BOTTOM PANEL		0E1351C1	XEBC EXTERNAL BOTTOM PANEL	
0F1503A	XEBC-04EU-E BACK PANEL		0F1503A0	XEBC-04EU-E BACK PANEL	







COMPONENT			SPARE PART																						
Code	Description	Image	Code	Description	Kit components																				
VM1750A	BRASS COMB CLAM		KVM1750A	COMB TERMINAL BLOCK KIT	<table border="1"> <thead> <tr> <th>Code</th> <th>Description</th> <th>Qty</th> <th>UOM</th> </tr> </thead> <tbody> <tr> <td>VI1040A0</td> <td>INDENTED INTERNAL WASHER D=6 ZN</td> <td>2.000</td> <td>PC</td> </tr> <tr> <td>VM1750A0</td> <td>BRASS COMB CLAMP</td> <td>1.000</td> <td>PC</td> </tr> </tbody> </table>	Code	Description	Qty	UOM	VI1040A0	INDENTED INTERNAL WASHER D=6 ZN	2.000	PC	VM1750A0	BRASS COMB CLAMP	1.000	PC								
Code	Description	Qty	UOM																						
VI1040A0	INDENTED INTERNAL WASHER D=6 ZN	2.000	PC																						
VM1750A0	BRASS COMB CLAMP	1.000	PC																						
VM1630A	INTERNAL GLASS PUSHING CAP		KVM1630A	CAP FOR INTERNAL GLASS 10 PCS KIT	<table border="1"> <thead> <tr> <th>Code</th> <th>Description</th> <th>Qty</th> <th>UOM</th> </tr> </thead> <tbody> <tr> <td>VM1630A1</td> <td>INTERNAL GLASS PUSHING CAP</td> <td>10.000</td> <td>PC</td> </tr> </tbody> </table>	Code	Description	Qty	UOM	VM1630A1	INTERNAL GLASS PUSHING CAP	10.000	PC												
Code	Description	Qty	UOM																						
VM1630A1	INTERNAL GLASS PUSHING CAP	10.000	PC																						
VM2280B	HANDLE LATCH PLATE COVER		KVM2280B	VM2280B -M HANDLE LATCH PLATE COVER KIT	<table border="1"> <thead> <tr> <th>Code</th> <th>Description</th> <th>Qty</th> <th>UOM</th> </tr> </thead> <tbody> <tr> <td>VI1074A0</td> <td>4X16 SCREW FOR PLASTIC</td> <td>2.000</td> <td>PC</td> </tr> <tr> <td>VM1630A1</td> <td>INTERNAL GLASS PUSHING CAP</td> <td>2.000</td> <td>PC</td> </tr> <tr> <td>VM2280B0</td> <td>HANDLE LATCH PLATE COVER</td> <td>1.000</td> <td>PC</td> </tr> </tbody> </table>	Code	Description	Qty	UOM	VI1074A0	4X16 SCREW FOR PLASTIC	2.000	PC	VM1630A1	INTERNAL GLASS PUSHING CAP	2.000	PC	VM2280B0	HANDLE LATCH PLATE COVER	1.000	PC				
Code	Description	Qty	UOM																						
VI1074A0	4X16 SCREW FOR PLASTIC	2.000	PC																						
VM1630A1	INTERNAL GLASS PUSHING CAP	2.000	PC																						
VM2280B0	HANDLE LATCH PLATE COVER	1.000	PC																						
VP1530A	BT CT RIGHT HANDLE LATCH		KVM1190A	CHEFTOP/BAKERTO P DOOR RIGHT LATCH KIT	<table border="1"> <thead> <tr> <th>Code</th> <th>Description</th> <th>Qty</th> <th>UOM</th> </tr> </thead> <tbody> <tr> <td>VI0239A1</td> <td>SELF-TAPPIN G SCREW 4.2X25 TCB+ INOX</td> <td>2.000</td> <td>PC</td> </tr> <tr> <td>VI1220A1</td> <td>4,2x12 TCB SELF-TAPPIN G SCREW</td> <td>2.000</td> <td>PC</td> </tr> <tr> <td>VM1460A0</td> <td>XBC/XVC RIGHT DOOR LATCH CAP</td> <td>1.000</td> <td>PC</td> </tr> <tr> <td>VP1530A0</td> <td>BT CT RIGHT HANDLE LATC</td> <td>1.000</td> <td>PC</td> </tr> </tbody> </table>	Code	Description	Qty	UOM	VI0239A1	SELF-TAPPIN G SCREW 4.2X25 TCB+ INOX	2.000	PC	VI1220A1	4,2x12 TCB SELF-TAPPIN G SCREW	2.000	PC	VM1460A0	XBC/XVC RIGHT DOOR LATCH CAP	1.000	PC	VP1530A0	BT CT RIGHT HANDLE LATC	1.000	PC
Code	Description	Qty	UOM																						
VI0239A1	SELF-TAPPIN G SCREW 4.2X25 TCB+ INOX	2.000	PC																						
VI1220A1	4,2x12 TCB SELF-TAPPIN G SCREW	2.000	PC																						
VM1460A0	XBC/XVC RIGHT DOOR LATCH CAP	1.000	PC																						
VP1530A0	BT CT RIGHT HANDLE LATC	1.000	PC																						
VM1190A	CT BT RIGHT DOOR SPRING LATCH		KVM1190A	CHEFTOP/BAKERTO P DOOR RIGHT LATCH KIT	<table border="1"> <thead> <tr> <th>Code</th> <th>Description</th> <th>Qty</th> <th>UOM</th> </tr> </thead> <tbody> <tr> <td>VI0239A1</td> <td>SELF-TAPPIN G SCREW 4.2X25 TCB+ INOX</td> <td>2.000</td> <td>PC</td> </tr> <tr> <td>VI1220A1</td> <td>4,2x12 TCB SELF-TAPPIN G SCREW</td> <td>2.000</td> <td>PC</td> </tr> <tr> <td>VM1460A0</td> <td>XBC/XVC RIGHT DOOR LATCH CAP</td> <td>1.000</td> <td>PC</td> </tr> <tr> <td>VP1530A0</td> <td>BT CT RIGHT HANDLE LATC</td> <td>1.000</td> <td>PC</td> </tr> </tbody> </table>	Code	Description	Qty	UOM	VI0239A1	SELF-TAPPIN G SCREW 4.2X25 TCB+ INOX	2.000	PC	VI1220A1	4,2x12 TCB SELF-TAPPIN G SCREW	2.000	PC	VM1460A0	XBC/XVC RIGHT DOOR LATCH CAP	1.000	PC	VP1530A0	BT CT RIGHT HANDLE LATC	1.000	PC
Code	Description	Qty	UOM																						
VI0239A1	SELF-TAPPIN G SCREW 4.2X25 TCB+ INOX	2.000	PC																						
VI1220A1	4,2x12 TCB SELF-TAPPIN G SCREW	2.000	PC																						
VM1460A0	XBC/XVC RIGHT DOOR LATCH CAP	1.000	PC																						
VP1530A0	BT CT RIGHT HANDLE LATC	1.000	PC																						

COMPONENT			SPARE PART																						
Code	Description	Image	Code	Description	Kit components																				
VM1192A	CT BT DOOR SPRING LATCH BACK COVER		KVM1191A	CHEFTOP/BAKERTO P DOOR LEFT LATCH KIT	<table border="1"> <thead> <tr> <th>Code</th> <th>Description</th> <th>Qty</th> <th>UOM</th> </tr> </thead> <tbody> <tr> <td>VI0239A1</td> <td>SELF-TAPPIN G SCREW 4.2X25 TCB+ INOX</td> <td>2.000</td> <td>PC</td> </tr> <tr> <td>VI1220A1</td> <td>4.2x12 TCB SELF-TAPPIN G SCREW</td> <td>2.000</td> <td>PC</td> </tr> <tr> <td>VM1460A0</td> <td>XBC/XVC RIGHT DOOR LATCH CAP</td> <td>1.000</td> <td>PC</td> </tr> <tr> <td>VP1531A0</td> <td>BT CT LEFT HANDLE LATC</td> <td>1.000</td> <td>PC</td> </tr> </tbody> </table>	Code	Description	Qty	UOM	VI0239A1	SELF-TAPPIN G SCREW 4.2X25 TCB+ INOX	2.000	PC	VI1220A1	4.2x12 TCB SELF-TAPPIN G SCREW	2.000	PC	VM1460A0	XBC/XVC RIGHT DOOR LATCH CAP	1.000	PC	VP1531A0	BT CT LEFT HANDLE LATC	1.000	PC
			Code	Description	Qty	UOM																			
VI0239A1	SELF-TAPPIN G SCREW 4.2X25 TCB+ INOX	2.000	PC																						
VI1220A1	4.2x12 TCB SELF-TAPPIN G SCREW	2.000	PC																						
VM1460A0	XBC/XVC RIGHT DOOR LATCH CAP	1.000	PC																						
VP1531A0	BT CT LEFT HANDLE LATC	1.000	PC																						
KVM1190A	CHEFTOP/BAKERTO P DOOR RIGHT LATCH KIT	<table border="1"> <thead> <tr> <th>Code</th> <th>Description</th> <th>Qty</th> <th>UOM</th> </tr> </thead> <tbody> <tr> <td>VI0239A1</td> <td>SELF-TAPPIN G SCREW 4.2X25 TCB+ INOX</td> <td>2.000</td> <td>PC</td> </tr> <tr> <td>VI1220A1</td> <td>4.2x12 TCB SELF-TAPPIN G SCREW</td> <td>2.000</td> <td>PC</td> </tr> <tr> <td>VM1460A0</td> <td>XBC/XVC RIGHT DOOR LATCH CAP</td> <td>1.000</td> <td>PC</td> </tr> <tr> <td>VP1530A0</td> <td>BT CT RIGHT HANDLE LATC</td> <td>1.000</td> <td>PC</td> </tr> </tbody> </table>	Code	Description	Qty	UOM	VI0239A1	SELF-TAPPIN G SCREW 4.2X25 TCB+ INOX	2.000	PC	VI1220A1	4.2x12 TCB SELF-TAPPIN G SCREW	2.000	PC	VM1460A0	XBC/XVC RIGHT DOOR LATCH CAP	1.000	PC	VP1530A0	BT CT RIGHT HANDLE LATC	1.000	PC			
Code	Description	Qty	UOM																						
VI0239A1	SELF-TAPPIN G SCREW 4.2X25 TCB+ INOX	2.000	PC																						
VI1220A1	4.2x12 TCB SELF-TAPPIN G SCREW	2.000	PC																						
VM1460A0	XBC/XVC RIGHT DOOR LATCH CAP	1.000	PC																						
VP1530A0	BT CT RIGHT HANDLE LATC	1.000	PC																						
VM2281A	DOOR LATCH HOLES COVER		KVM2281A	HOLE PLATE COVER KIT	<table border="1"> <thead> <tr> <th>Code</th> <th>Description</th> <th>Qty</th> <th>UOM</th> </tr> </thead> <tbody> <tr> <td>VM2281A0</td> <td>DOOR LATCH HOLES COVER</td> <td>1.000</td> <td>PC</td> </tr> </tbody> </table>	Code	Description	Qty	UOM	VM2281A0	DOOR LATCH HOLES COVER	1.000	PC												
Code	Description	Qty	UOM																						
VM2281A0	DOOR LATCH HOLES COVER	1.000	PC																						
VP1531A	BT CT LEFT HANDLE LATCH		KVM1191A	CHEFTOP/BAKERTO P DOOR LEFT LATCH KIT	<table border="1"> <thead> <tr> <th>Code</th> <th>Description</th> <th>Qty</th> <th>UOM</th> </tr> </thead> <tbody> <tr> <td>VI0239A1</td> <td>SELF-TAPPIN G SCREW 4.2X25 TCB+ INOX</td> <td>2.000</td> <td>PC</td> </tr> <tr> <td>VI1220A1</td> <td>4,2x12 TCB SELF-TAPPIN G SCREW</td> <td>2.000</td> <td>PC</td> </tr> <tr> <td>VM1460A0</td> <td>XBC/XVC RIGHT DOOR LATCH CAP</td> <td>1.000</td> <td>PC</td> </tr> <tr> <td>VP1531A0</td> <td>BT CT LEFT HANDLE LATC</td> <td>1.000</td> <td>PC</td> </tr> </tbody> </table>	Code	Description	Qty	UOM	VI0239A1	SELF-TAPPIN G SCREW 4.2X25 TCB+ INOX	2.000	PC	VI1220A1	4,2x12 TCB SELF-TAPPIN G SCREW	2.000	PC	VM1460A0	XBC/XVC RIGHT DOOR LATCH CAP	1.000	PC	VP1531A0	BT CT LEFT HANDLE LATC	1.000	PC
					Code	Description	Qty	UOM																	
					VI0239A1	SELF-TAPPIN G SCREW 4.2X25 TCB+ INOX	2.000	PC																	
					VI1220A1	4,2x12 TCB SELF-TAPPIN G SCREW	2.000	PC																	
VM1460A0	XBC/XVC RIGHT DOOR LATCH CAP	1.000	PC																						
VP1531A0	BT CT LEFT HANDLE LATC	1.000	PC																						

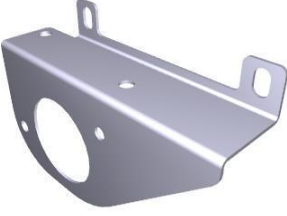



COMPONENT			SPARE PART																						
Code	Description	Image	Code	Description	Kit components																				
VM1191A	CT BT LEFT DOOR SPRING LATCH		KVM1191A	CHEFTOP/BAKERTO P DOOR LEFT LATCH KIT	<table border="1"> <thead> <tr> <th>Code</th> <th>Description</th> <th>Qty</th> <th>UOM</th> </tr> </thead> <tbody> <tr> <td>VI0239A1</td> <td>SELF-TAPPIN G SCREW 4.2X25 TCB+ INOX</td> <td>2.000</td> <td>PC</td> </tr> <tr> <td>VI1220A1</td> <td>4.2x12 TCB SELF-TAPPIN G SCREW</td> <td>2.000</td> <td>PC</td> </tr> <tr> <td>VM1460A0</td> <td>XBC/XVC RIGHT DOOR LATCH CAP</td> <td>1.000</td> <td>PC</td> </tr> <tr> <td>VP1531A0</td> <td>BT CT LEFT HANDLE LATC</td> <td>1.000</td> <td>PC</td> </tr> </tbody> </table>	Code	Description	Qty	UOM	VI0239A1	SELF-TAPPIN G SCREW 4.2X25 TCB+ INOX	2.000	PC	VI1220A1	4.2x12 TCB SELF-TAPPIN G SCREW	2.000	PC	VM1460A0	XBC/XVC RIGHT DOOR LATCH CAP	1.000	PC	VP1531A0	BT CT LEFT HANDLE LATC	1.000	PC
					Code	Description	Qty	UOM																	
					VI0239A1	SELF-TAPPIN G SCREW 4.2X25 TCB+ INOX	2.000	PC																	
					VI1220A1	4.2x12 TCB SELF-TAPPIN G SCREW	2.000	PC																	
VM1460A0	XBC/XVC RIGHT DOOR LATCH CAP	1.000	PC																						
VP1531A0	BT CT LEFT HANDLE LATC	1.000	PC																						
<table border="1"> <thead> <tr> <th>Code</th> <th>Description</th> <th>Qty</th> <th>UOM</th> </tr> </thead> <tbody> <tr> <td>VI0239A1</td> <td>SELF-TAPPIN G SCREW 4.2X25 TCB+ INOX</td> <td>2.000</td> <td>PC</td> </tr> <tr> <td>VI1220A1</td> <td>4.2x12 TCB SELF-TAPPIN G SCREW</td> <td>2.000</td> <td>PC</td> </tr> <tr> <td>VM1460A0</td> <td>XBC/XVC RIGHT DOOR LATCH CAP</td> <td>1.000</td> <td>PC</td> </tr> <tr> <td>VP1531A0</td> <td>BT CT LEFT HANDLE LATC</td> <td>1.000</td> <td>PC</td> </tr> </tbody> </table>	Code	Description	Qty	UOM	VI0239A1	SELF-TAPPIN G SCREW 4.2X25 TCB+ INOX	2.000	PC	VI1220A1	4.2x12 TCB SELF-TAPPIN G SCREW	2.000	PC	VM1460A0	XBC/XVC RIGHT DOOR LATCH CAP	1.000	PC	VP1531A0	BT CT LEFT HANDLE LATC	1.000	PC					
Code	Description	Qty	UOM																						
VI0239A1	SELF-TAPPIN G SCREW 4.2X25 TCB+ INOX	2.000	PC																						
VI1220A1	4.2x12 TCB SELF-TAPPIN G SCREW	2.000	PC																						
VM1460A0	XBC/XVC RIGHT DOOR LATCH CAP	1.000	PC																						
VP1531A0	BT CT LEFT HANDLE LATC	1.000	PC																						
<table border="1"> <thead> <tr> <th>Code</th> <th>Description</th> <th>Qty</th> <th>UOM</th> </tr> </thead> <tbody> <tr> <td>VI0239A1</td> <td>SELF-TAPPIN G SCREW 4.2X25 TCB+ INOX</td> <td>2.000</td> <td>PC</td> </tr> <tr> <td>VI1220A1</td> <td>4.2x12 TCB SELF-TAPPIN G SCREW</td> <td>2.000</td> <td>PC</td> </tr> <tr> <td>VM1460A0</td> <td>XBC/XVC RIGHT DOOR LATCH CAP</td> <td>1.000</td> <td>PC</td> </tr> <tr> <td>VP1531A0</td> <td>BT CT LEFT HANDLE LATC</td> <td>1.000</td> <td>PC</td> </tr> </tbody> </table>	Code	Description	Qty	UOM	VI0239A1	SELF-TAPPIN G SCREW 4.2X25 TCB+ INOX	2.000	PC	VI1220A1	4.2x12 TCB SELF-TAPPIN G SCREW	2.000	PC	VM1460A0	XBC/XVC RIGHT DOOR LATCH CAP	1.000	PC	VP1531A0	BT CT LEFT HANDLE LATC	1.000	PC					
Code	Description	Qty	UOM																						
VI0239A1	SELF-TAPPIN G SCREW 4.2X25 TCB+ INOX	2.000	PC																						
VI1220A1	4.2x12 TCB SELF-TAPPIN G SCREW	2.000	PC																						
VM1460A0	XBC/XVC RIGHT DOOR LATCH CAP	1.000	PC																						
VP1531A0	BT CT LEFT HANDLE LATC	1.000	PC																						
<table border="1"> <thead> <tr> <th>Code</th> <th>Description</th> <th>Qty</th> <th>UOM</th> </tr> </thead> <tbody> <tr> <td>VI0239A1</td> <td>SELF-TAPPIN G SCREW 4.2X25 TCB+ INOX</td> <td>2.000</td> <td>PC</td> </tr> <tr> <td>VI1220A1</td> <td>4.2x12 TCB SELF-TAPPIN G SCREW</td> <td>2.000</td> <td>PC</td> </tr> <tr> <td>VM1460A0</td> <td>XBC/XVC RIGHT DOOR LATCH CAP</td> <td>1.000</td> <td>PC</td> </tr> <tr> <td>VP1530A0</td> <td>BT CT RIGHT HANDLE LATC</td> <td>1.000</td> <td>PC</td> </tr> </tbody> </table>	Code	Description	Qty	UOM	VI0239A1	SELF-TAPPIN G SCREW 4.2X25 TCB+ INOX	2.000	PC	VI1220A1	4.2x12 TCB SELF-TAPPIN G SCREW	2.000	PC	VM1460A0	XBC/XVC RIGHT DOOR LATCH CAP	1.000	PC	VP1530A0	BT CT RIGHT HANDLE LATC	1.000	PC					
Code	Description	Qty	UOM																						
VI0239A1	SELF-TAPPIN G SCREW 4.2X25 TCB+ INOX	2.000	PC																						
VI1220A1	4.2x12 TCB SELF-TAPPIN G SCREW	2.000	PC																						
VM1460A0	XBC/XVC RIGHT DOOR LATCH CAP	1.000	PC																						
VP1530A0	BT CT RIGHT HANDLE LATC	1.000	PC																						
VM1192A	CT BT DOOR SPRING LATCH BACK COVER		KVM1191A	CHEFTOP/BAKERTO P DOOR LEFT LATCH KIT	<table border="1"> <thead> <tr> <th>Code</th> <th>Description</th> <th>Qty</th> <th>UOM</th> </tr> </thead> <tbody> <tr> <td>VI0239A1</td> <td>SELF-TAPPIN G SCREW 4.2X25 TCB+ INOX</td> <td>2.000</td> <td>PC</td> </tr> <tr> <td>VI1220A1</td> <td>4.2x12 TCB SELF-TAPPIN G SCREW</td> <td>2.000</td> <td>PC</td> </tr> <tr> <td>VM1460A0</td> <td>XBC/XVC RIGHT DOOR LATCH CAP</td> <td>1.000</td> <td>PC</td> </tr> <tr> <td>VP1531A0</td> <td>BT CT LEFT HANDLE LATC</td> <td>1.000</td> <td>PC</td> </tr> </tbody> </table>	Code	Description	Qty	UOM	VI0239A1	SELF-TAPPIN G SCREW 4.2X25 TCB+ INOX	2.000	PC	VI1220A1	4.2x12 TCB SELF-TAPPIN G SCREW	2.000	PC	VM1460A0	XBC/XVC RIGHT DOOR LATCH CAP	1.000	PC	VP1531A0	BT CT LEFT HANDLE LATC	1.000	PC
					Code	Description	Qty	UOM																	
					VI0239A1	SELF-TAPPIN G SCREW 4.2X25 TCB+ INOX	2.000	PC																	
					VI1220A1	4.2x12 TCB SELF-TAPPIN G SCREW	2.000	PC																	
VM1460A0	XBC/XVC RIGHT DOOR LATCH CAP	1.000	PC																						
VP1531A0	BT CT LEFT HANDLE LATC	1.000	PC																						
<table border="1"> <thead> <tr> <th>Code</th> <th>Description</th> <th>Qty</th> <th>UOM</th> </tr> </thead> <tbody> <tr> <td>VI0239A1</td> <td>SELF-TAPPIN G SCREW 4.2X25 TCB+ INOX</td> <td>2.000</td> <td>PC</td> </tr> <tr> <td>VI1220A1</td> <td>4.2x12 TCB SELF-TAPPIN G SCREW</td> <td>2.000</td> <td>PC</td> </tr> <tr> <td>VM1460A0</td> <td>XBC/XVC RIGHT DOOR LATCH CAP</td> <td>1.000</td> <td>PC</td> </tr> <tr> <td>VP1531A0</td> <td>BT CT LEFT HANDLE LATC</td> <td>1.000</td> <td>PC</td> </tr> </tbody> </table>	Code	Description	Qty	UOM	VI0239A1	SELF-TAPPIN G SCREW 4.2X25 TCB+ INOX	2.000	PC	VI1220A1	4.2x12 TCB SELF-TAPPIN G SCREW	2.000	PC	VM1460A0	XBC/XVC RIGHT DOOR LATCH CAP	1.000	PC	VP1531A0	BT CT LEFT HANDLE LATC	1.000	PC					
Code	Description	Qty	UOM																						
VI0239A1	SELF-TAPPIN G SCREW 4.2X25 TCB+ INOX	2.000	PC																						
VI1220A1	4.2x12 TCB SELF-TAPPIN G SCREW	2.000	PC																						
VM1460A0	XBC/XVC RIGHT DOOR LATCH CAP	1.000	PC																						
VP1531A0	BT CT LEFT HANDLE LATC	1.000	PC																						
<table border="1"> <thead> <tr> <th>Code</th> <th>Description</th> <th>Qty</th> <th>UOM</th> </tr> </thead> <tbody> <tr> <td>VI0239A1</td> <td>SELF-TAPPIN G SCREW 4.2X25 TCB+ INOX</td> <td>2.000</td> <td>PC</td> </tr> <tr> <td>VI1220A1</td> <td>4.2x12 TCB SELF-TAPPIN G SCREW</td> <td>2.000</td> <td>PC</td> </tr> <tr> <td>VM1460A0</td> <td>XBC/XVC RIGHT DOOR LATCH CAP</td> <td>1.000</td> <td>PC</td> </tr> <tr> <td>VP1530A0</td> <td>BT CT RIGHT HANDLE LATC</td> <td>1.000</td> <td>PC</td> </tr> </tbody> </table>	Code	Description	Qty	UOM	VI0239A1	SELF-TAPPIN G SCREW 4.2X25 TCB+ INOX	2.000	PC	VI1220A1	4.2x12 TCB SELF-TAPPIN G SCREW	2.000	PC	VM1460A0	XBC/XVC RIGHT DOOR LATCH CAP	1.000	PC	VP1530A0	BT CT RIGHT HANDLE LATC	1.000	PC					
Code	Description	Qty	UOM																						
VI0239A1	SELF-TAPPIN G SCREW 4.2X25 TCB+ INOX	2.000	PC																						
VI1220A1	4.2x12 TCB SELF-TAPPIN G SCREW	2.000	PC																						
VM1460A0	XBC/XVC RIGHT DOOR LATCH CAP	1.000	PC																						
VP1530A0	BT CT RIGHT HANDLE LATC	1.000	PC																						
<table border="1"> <thead> <tr> <th>Code</th> <th>Description</th> <th>Qty</th> <th>UOM</th> </tr> </thead> <tbody> <tr> <td>VI0239A1</td> <td>SELF-TAPPIN G SCREW 4.2X25 TCB+ INOX</td> <td>2.000</td> <td>PC</td> </tr> <tr> <td>VI1220A1</td> <td>4.2x12 TCB SELF-TAPPIN G SCREW</td> <td>2.000</td> <td>PC</td> </tr> <tr> <td>VM1460A0</td> <td>XBC/XVC RIGHT DOOR LATCH CAP</td> <td>1.000</td> <td>PC</td> </tr> <tr> <td>VP1530A0</td> <td>BT CT RIGHT HANDLE LATC</td> <td>1.000</td> <td>PC</td> </tr> </tbody> </table>	Code	Description	Qty	UOM	VI0239A1	SELF-TAPPIN G SCREW 4.2X25 TCB+ INOX	2.000	PC	VI1220A1	4.2x12 TCB SELF-TAPPIN G SCREW	2.000	PC	VM1460A0	XBC/XVC RIGHT DOOR LATCH CAP	1.000	PC	VP1530A0	BT CT RIGHT HANDLE LATC	1.000	PC					
Code	Description	Qty	UOM																						
VI0239A1	SELF-TAPPIN G SCREW 4.2X25 TCB+ INOX	2.000	PC																						
VI1220A1	4.2x12 TCB SELF-TAPPIN G SCREW	2.000	PC																						
VM1460A0	XBC/XVC RIGHT DOOR LATCH CAP	1.000	PC																						
VP1530A0	BT CT RIGHT HANDLE LATC	1.000	PC																						
SB1015A	4L COMPLETE DETERGENT TANK		KSB1015A	4L DETERGENT TANK KIT	<table border="1"> <thead> <tr> <th>Code</th> <th>Description</th> <th>Qty</th> <th>UOM</th> </tr> </thead> <tbody> <tr> <td>SB1015A3</td> <td>4L COMPLETE DETERGENT TANK</td> <td>1.000</td> <td>PC</td> </tr> </tbody> </table>	Code	Description	Qty	UOM	SB1015A3	4L COMPLETE DETERGENT TANK	1.000	PC												
					Code	Description	Qty	UOM																	
SB1015A3	4L COMPLETE DETERGENT TANK	1.000	PC																						
<table border="1"> <thead> <tr> <th>Code</th> <th>Description</th> <th>Qty</th> <th>UOM</th> </tr> </thead> <tbody> <tr> <td>SB1015A3</td> <td>4L COMPLETE DETERGENT TANK</td> <td>1.000</td> <td>PC</td> </tr> </tbody> </table>	Code	Description	Qty	UOM	SB1015A3	4L COMPLETE DETERGENT TANK	1.000	PC																	
Code	Description	Qty	UOM																						
SB1015A3	4L COMPLETE DETERGENT TANK	1.000	PC																						

COMPONENT			SPARE PART																						
Code	Description	Image	Code	Description	Kit components																				
VM1118A	DET&Rinse PLUS TANK LEFT GUIDE		KVM1118A	DET&RINSE TANK LEFT GUIDE KIT FOR MM	<table border="1"> <thead> <tr> <th>Code</th> <th>Description</th> <th>Qty</th> <th>UOM</th> </tr> </thead> <tbody> <tr> <td>VI1220A1</td> <td>4,2x12 TCB SELF-TAPPIN G SCREW</td> <td>2.000</td> <td>PC</td> </tr> <tr> <td>VM1118A0</td> <td>DET&Rinse PLUS TANK LEFT GUIDE</td> <td>1.000</td> <td>PC</td> </tr> </tbody> </table>	Code	Description	Qty	UOM	VI1220A1	4,2x12 TCB SELF-TAPPIN G SCREW	2.000	PC	VM1118A0	DET&Rinse PLUS TANK LEFT GUIDE	1.000	PC								
Code	Description	Qty	UOM																						
VI1220A1	4,2x12 TCB SELF-TAPPIN G SCREW	2.000	PC																						
VM1118A0	DET&Rinse PLUS TANK LEFT GUIDE	1.000	PC																						
VM1119A	DET&Rinse PLUS TANK RIGHT GUIDE		KVM1119A	DET&RINSE TANK RIGHT GUIDE KIT FOR MM	<table border="1"> <thead> <tr> <th>Code</th> <th>Description</th> <th>Qty</th> <th>UOM</th> </tr> </thead> <tbody> <tr> <td>VI1220A1</td> <td>4,2x12 TCB SELF-TAPPIN G SCREW</td> <td>2.000</td> <td>PC</td> </tr> <tr> <td>VM1119A0</td> <td>DET&Rinse PLUS TANK RIGHT GUIDE</td> <td>1.000</td> <td>PC</td> </tr> </tbody> </table>	Code	Description	Qty	UOM	VI1220A1	4,2x12 TCB SELF-TAPPIN G SCREW	2.000	PC	VM1119A0	DET&Rinse PLUS TANK RIGHT GUIDE	1.000	PC								
Code	Description	Qty	UOM																						
VI1220A1	4,2x12 TCB SELF-TAPPIN G SCREW	2.000	PC																						
VM1119A0	DET&Rinse PLUS TANK RIGHT GUIDE	1.000	PC																						
OH8038A	MM REDUCER SUPPORT PLATE		OH8038A0	MM REDUCER SUPPORT PLATE																					
RC1396A	JG D10-1/4 STRAIGHT END FITTING		KVL0014B	≥2017 MIND.MAPS PRESSURE REDUCER KIT	<table border="1"> <thead> <tr> <th>Code</th> <th>Description</th> <th>Qty</th> <th>UOM</th> </tr> </thead> <tbody> <tr> <td>RC1372A0</td> <td>Ø10M-1/4 M CIL. STRAIGHT FITTING</td> <td>1.000</td> <td>PC</td> </tr> <tr> <td>RC1396A0</td> <td>JG D10-1/4 STRAIGHT END FITTING</td> <td>1.000</td> <td>PC</td> </tr> <tr> <td>VL1014B3</td> <td>VL1014B3</td> <td>1.000</td> <td>PC</td> </tr> <tr> <td>VM1054A0</td> <td>H7.8 PRESSURE REDUCER RING NUT</td> <td>1.000</td> <td>PC</td> </tr> </tbody> </table>	Code	Description	Qty	UOM	RC1372A0	Ø10M-1/4 M CIL. STRAIGHT FITTING	1.000	PC	RC1396A0	JG D10-1/4 STRAIGHT END FITTING	1.000	PC	VL1014B3	VL1014B3	1.000	PC	VM1054A0	H7.8 PRESSURE REDUCER RING NUT	1.000	PC
Code	Description	Qty	UOM																						
RC1372A0	Ø10M-1/4 M CIL. STRAIGHT FITTING	1.000	PC																						
RC1396A0	JG D10-1/4 STRAIGHT END FITTING	1.000	PC																						
VL1014B3	VL1014B3	1.000	PC																						
VM1054A0	H7.8 PRESSURE REDUCER RING NUT	1.000	PC																						
VL1014B	VL1014B3		KVL0020A	PRESS.REDUCER 03-05XX≥OCT18/MM -LUX≥MAR19	<table border="1"> <thead> <tr> <th>Code</th> <th>Description</th> <th>Qty</th> <th>UOM</th> </tr> </thead> <tbody> <tr> <td>RC1396A0</td> <td>JG D10-1/4 STRAIGHT END FITTING</td> <td>2.000</td> <td>PC</td> </tr> <tr> <td>VL1014B3</td> <td>VL1014B3</td> <td>1.000</td> <td>PC</td> </tr> <tr> <td>VM1054A0</td> <td>H7.8 PRESSURE REDUCER RING NUT</td> <td>1.000</td> <td>PC</td> </tr> </tbody> </table>	Code	Description	Qty	UOM	RC1396A0	JG D10-1/4 STRAIGHT END FITTING	2.000	PC	VL1014B3	VL1014B3	1.000	PC	VM1054A0	H7.8 PRESSURE REDUCER RING NUT	1.000	PC				
Code	Description	Qty	UOM																						
RC1396A0	JG D10-1/4 STRAIGHT END FITTING	2.000	PC																						
VL1014B3	VL1014B3	1.000	PC																						
VM1054A0	H7.8 PRESSURE REDUCER RING NUT	1.000	PC																						

COMPONENT			SPARE PART																											
Code	Description	Image	Code	Description	Kit components																									
VL1014B	VL1014B3		KVL0014B	≥2017 MIND.MAPS PRESSURE REDUCER KIT	<table border="1"> <thead> <tr> <th>Code</th> <th>Description</th> <th>Qty</th> <th>UOM</th> </tr> </thead> <tbody> <tr> <td>RC1372A0</td> <td>Ø10M-1/4 M CIL. STRAIGHT FITTING</td> <td>1.000</td> <td>PC</td> </tr> <tr> <td>RC1396A0</td> <td>JG D10-1/4 STRAIGHT END FITTING</td> <td>1.000</td> <td>PC</td> </tr> <tr> <td>VL1014B3</td> <td>VL1014B3</td> <td>1.000</td> <td>PC</td> </tr> <tr> <td>VM1054A0</td> <td>H7.8 PRESSURE REDUCER RING NUT</td> <td>1.000</td> <td>PC</td> </tr> </tbody> </table>	Code	Description	Qty	UOM	RC1372A0	Ø10M-1/4 M CIL. STRAIGHT FITTING	1.000	PC	RC1396A0	JG D10-1/4 STRAIGHT END FITTING	1.000	PC	VL1014B3	VL1014B3	1.000	PC	VM1054A0	H7.8 PRESSURE REDUCER RING NUT	1.000	PC					
			Code	Description	Qty	UOM																								
			RC1372A0	Ø10M-1/4 M CIL. STRAIGHT FITTING	1.000	PC																								
RC1396A0	JG D10-1/4 STRAIGHT END FITTING	1.000	PC																											
VL1014B3	VL1014B3	1.000	PC																											
VM1054A0	H7.8 PRESSURE REDUCER RING NUT	1.000	PC																											
KVL0014A	MM ≤2016 / LUX<2019 PRESSURE REDUCER KIT	<table border="1"> <thead> <tr> <th>Code</th> <th>Description</th> <th>Qty</th> <th>UOM</th> </tr> </thead> <tbody> <tr> <td>RC1372A0</td> <td>Ø10M-1/4 M CIL. STRAIGHT FITTING</td> <td>2.000</td> <td>PC</td> </tr> <tr> <td>VL1014B3</td> <td>VL1014B3</td> <td>1.000</td> <td>PC</td> </tr> <tr> <td>VM1054A0</td> <td>H7.8 PRESSURE REDUCER RING NUT</td> <td>1.000</td> <td>PC</td> </tr> </tbody> </table>	Code	Description	Qty	UOM	RC1372A0	Ø10M-1/4 M CIL. STRAIGHT FITTING	2.000	PC	VL1014B3	VL1014B3	1.000	PC	VM1054A0	H7.8 PRESSURE REDUCER RING NUT	1.000	PC												
Code	Description	Qty	UOM																											
RC1372A0	Ø10M-1/4 M CIL. STRAIGHT FITTING	2.000	PC																											
VL1014B3	VL1014B3	1.000	PC																											
VM1054A0	H7.8 PRESSURE REDUCER RING NUT	1.000	PC																											
KVL0010A	S.4 - 5 WATER PRESSURE REDUCER KIT	<table border="1"> <thead> <tr> <th>Code</th> <th>Description</th> <th>Qty</th> <th>UOM</th> </tr> </thead> <tbody> <tr> <td>EL1210A0</td> <td>D8-BSP1/4 JG STRAIGHT END CONNECTION</td> <td>2.000</td> <td>PC</td> </tr> <tr> <td>VL1014B3</td> <td>VL1014B3</td> <td>1.000</td> <td>PC</td> </tr> </tbody> </table>	Code	Description	Qty	UOM	EL1210A0	D8-BSP1/4 JG STRAIGHT END CONNECTION	2.000	PC	VL1014B3	VL1014B3	1.000	PC																
Code	Description	Qty	UOM																											
EL1210A0	D8-BSP1/4 JG STRAIGHT END CONNECTION	2.000	PC																											
VL1014B3	VL1014B3	1.000	PC																											
VM1054A	H7.8 PRESSURE REDUCER RING NUT		KVM1054A	H7.8 PRESSURE REDUCER DIAL KIT	<table border="1"> <thead> <tr> <th>Code</th> <th>Description</th> <th>Qty</th> <th>UOM</th> </tr> </thead> <tbody> <tr> <td>VM1054A0</td> <td>H7.8 PRESSURE REDUCER RING NUT</td> <td>1.000</td> <td>PC</td> </tr> </tbody> </table>	Code	Description	Qty	UOM	VM1054A0	H7.8 PRESSURE REDUCER RING NUT	1.000	PC																	
			Code	Description	Qty	UOM																								
VM1054A0	H7.8 PRESSURE REDUCER RING NUT	1.000	PC																											
KVL1117A	EUR MM 2016+LMT FILTER+PRESS. RED. KIT	<table border="1"> <thead> <tr> <th>Code</th> <th>Description</th> <th>Qty</th> <th>UOM</th> </tr> </thead> <tbody> <tr> <td>0H7472A1</td> <td>DISTRIBUTOR SUPPORT PLATE</td> <td>1.000</td> <td>PC</td> </tr> <tr> <td>RC1004A0</td> <td>Ø10-Ø8-8 Y CONNECTION</td> <td>1.000</td> <td>PC</td> </tr> <tr> <td>RC1243A0</td> <td>Ø10F-Ø10M ELBOW CONNECTION + JG END KIT</td> <td>1.000</td> <td>PC</td> </tr> <tr> <td>RC1372A0</td> <td>Ø10M-1/4 M CIL. STRAIGHT FITTING</td> <td>2.000</td> <td>PC</td> </tr> <tr> <td>VH1220A1</td> <td>4,2x12 TCB SELF-TAPPIN G SCREW</td> <td>4.000</td> <td>PC</td> </tr> <tr> <td>VL1014B3</td> <td>VL1014B3</td> <td>1.000</td> <td>PC</td> </tr> </tbody> </table>	Code	Description	Qty	UOM	0H7472A1	DISTRIBUTOR SUPPORT PLATE	1.000	PC	RC1004A0	Ø10-Ø8-8 Y CONNECTION	1.000	PC	RC1243A0	Ø10F-Ø10M ELBOW CONNECTION + JG END KIT	1.000	PC	RC1372A0	Ø10M-1/4 M CIL. STRAIGHT FITTING	2.000	PC	VH1220A1	4,2x12 TCB SELF-TAPPIN G SCREW	4.000	PC	VL1014B3	VL1014B3	1.000	PC
Code	Description	Qty	UOM																											
0H7472A1	DISTRIBUTOR SUPPORT PLATE	1.000	PC																											
RC1004A0	Ø10-Ø8-8 Y CONNECTION	1.000	PC																											
RC1243A0	Ø10F-Ø10M ELBOW CONNECTION + JG END KIT	1.000	PC																											
RC1372A0	Ø10M-1/4 M CIL. STRAIGHT FITTING	2.000	PC																											
VH1220A1	4,2x12 TCB SELF-TAPPIN G SCREW	4.000	PC																											
VL1014B3	VL1014B3	1.000	PC																											

COMPONENT			SPARE PART																																																		
Code	Description	Image	Code	Description	Kit components																																																
VM1054A	H7.8 PRESSURE REDUCER RING NUT		KVL1117A	EUR MM 2016+LMT FILTER+PRESS. RED. KIT	<table border="1"> <thead> <tr> <th>Code</th> <th>Description</th> <th>Qty</th> <th>UOM</th> </tr> </thead> <tbody> <tr> <td>VL1034C0</td> <td>MESH WATER FILTER D10</td> <td>1.000</td> <td>PC</td> </tr> <tr> <td>VL1062C0</td> <td>PRESSURE REDUCER-FILTER LOCKING FORK</td> <td>1.000</td> <td>PC</td> </tr> <tr> <td>VM1054A0</td> <td>H7.8 PRESSURE REDUCER RING NUT</td> <td>1.000</td> <td>PC</td> </tr> </tbody> </table>	Code	Description	Qty	UOM	VL1034C0	MESH WATER FILTER D10	1.000	PC	VL1062C0	PRESSURE REDUCER-FILTER LOCKING FORK	1.000	PC	VM1054A0	H7.8 PRESSURE REDUCER RING NUT	1.000	PC																																
					Code	Description	Qty	UOM																																													
VL1034C0	MESH WATER FILTER D10	1.000	PC																																																		
VL1062C0	PRESSURE REDUCER-FILTER LOCKING FORK	1.000	PC																																																		
VM1054A0	H7.8 PRESSURE REDUCER RING NUT	1.000	PC																																																		
RC1243A	Ø10F-Ø10M ELBOW CONNECTION + JG END KIT		KVL1163A	MINDMAPS INLET CONNECTING PIPE KIT	<table border="1"> <thead> <tr> <th>Code</th> <th>Description</th> <th>Qty</th> <th>UOM</th> </tr> </thead> <tbody> <tr> <td>0H8038A0</td> <td>MM REDUCER SUPPORT PLATE</td> <td>1.000</td> <td>PC</td> </tr> <tr> <td>0H8039A0</td> <td>MM COMPACT REDUCER SUPPORT PLATE</td> <td>1.000</td> <td>PC</td> </tr> <tr> <td>CH1026A0</td> <td>UNOX JOHN GUEST SPANNER D8-D10</td> <td>1.000</td> <td>PC</td> </tr> <tr> <td>RC1243A0</td> <td>Ø10F-Ø10M ELBOW CONNECTION + JG END KIT</td> <td>2.000</td> <td>PC</td> </tr> <tr> <td>RC1396A0</td> <td>JG D10-1/4 STRAIGHT END FITTING</td> <td>2.000</td> <td>PC</td> </tr> <tr> <td>TB2243A0</td> <td>D10 PE TRANSPARENT PIPE</td> <td>1.500</td> <td>M</td> </tr> <tr> <td>VI1220A1</td> <td>4,2x12 TCB SELF-TAPPING SCREW</td> <td>2.000</td> <td>PC</td> </tr> <tr> <td>VI1950A0</td> <td>ST. STEEL 4,2X13 TCB SELF-DRILLING SCREW</td> <td>1.000</td> <td>PC</td> </tr> <tr> <td>VL1014B3</td> <td>VL1014B3</td> <td>1.000</td> <td>PC</td> </tr> <tr> <td>VL1135A1</td> <td>3/4-JG10 CONNECTOR + FILTER AND NRV</td> <td>1.000</td> <td>PC</td> </tr> <tr> <td>VM1054A0</td> <td>H7.8 PRESSURE REDUCER RING NUT</td> <td>1.000</td> <td>PC</td> </tr> </tbody> </table>	Code	Description	Qty	UOM	0H8038A0	MM REDUCER SUPPORT PLATE	1.000	PC	0H8039A0	MM COMPACT REDUCER SUPPORT PLATE	1.000	PC	CH1026A0	UNOX JOHN GUEST SPANNER D8-D10	1.000	PC	RC1243A0	Ø10F-Ø10M ELBOW CONNECTION + JG END KIT	2.000	PC	RC1396A0	JG D10-1/4 STRAIGHT END FITTING	2.000	PC	TB2243A0	D10 PE TRANSPARENT PIPE	1.500	M	VI1220A1	4,2x12 TCB SELF-TAPPING SCREW	2.000	PC	VI1950A0	ST. STEEL 4,2X13 TCB SELF-DRILLING SCREW	1.000	PC	VL1014B3	VL1014B3	1.000	PC	VL1135A1	3/4-JG10 CONNECTOR + FILTER AND NRV	1.000	PC	VM1054A0	H7.8 PRESSURE REDUCER RING NUT	1.000	PC
Code	Description	Qty	UOM																																																		
0H8038A0	MM REDUCER SUPPORT PLATE	1.000	PC																																																		
0H8039A0	MM COMPACT REDUCER SUPPORT PLATE	1.000	PC																																																		
CH1026A0	UNOX JOHN GUEST SPANNER D8-D10	1.000	PC																																																		
RC1243A0	Ø10F-Ø10M ELBOW CONNECTION + JG END KIT	2.000	PC																																																		
RC1396A0	JG D10-1/4 STRAIGHT END FITTING	2.000	PC																																																		
TB2243A0	D10 PE TRANSPARENT PIPE	1.500	M																																																		
VI1220A1	4,2x12 TCB SELF-TAPPING SCREW	2.000	PC																																																		
VI1950A0	ST. STEEL 4,2X13 TCB SELF-DRILLING SCREW	1.000	PC																																																		
VL1014B3	VL1014B3	1.000	PC																																																		
VL1135A1	3/4-JG10 CONNECTOR + FILTER AND NRV	1.000	PC																																																		
VM1054A0	H7.8 PRESSURE REDUCER RING NUT	1.000	PC																																																		
			KRC1243A	Ø10F-Ø10M ELBOW CONN + JG END 10 PCS KIT	<table border="1"> <thead> <tr> <th>Code</th> <th>Description</th> <th>Qty</th> <th>UOM</th> </tr> </thead> <tbody> <tr> <td>RC1243A0</td> <td>Ø10F-Ø10M ELBOW CONNECTION + JG END KIT</td> <td>10.000</td> <td>PC</td> </tr> </tbody> </table>	Code	Description	Qty	UOM	RC1243A0	Ø10F-Ø10M ELBOW CONNECTION + JG END KIT	10.000	PC																																								
Code	Description	Qty	UOM																																																		
RC1243A0	Ø10F-Ø10M ELBOW CONNECTION + JG END KIT	10.000	PC																																																		

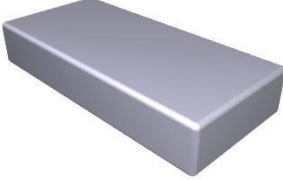

COMPONENT			SPARE PART										
Code	Description	Image	Code	Description	Kit components								
TB1099A	TB3130A-D10 WATER CONNECTING PIPE		KTB2599A	Ø10 PET WATER PIPE TB2243A0 100M KIT	<table border="1"> <thead> <tr> <th>Code</th> <th>Description</th> <th>Qty</th> <th>UOM</th> </tr> </thead> <tbody> <tr> <td>TB2243A0</td> <td>D10 PE TRANSPAREN T PIPE</td> <td>100.000</td> <td>M</td> </tr> </tbody> </table>	Code	Description	Qty	UOM	TB2243A0	D10 PE TRANSPAREN T PIPE	100.000	M
					Code	Description	Qty	UOM					
TB2243A0	D10 PE TRANSPAREN T PIPE	100.000	M										
<table border="1"> <thead> <tr> <th>Code</th> <th>Description</th> <th>Qty</th> <th>UOM</th> </tr> </thead> <tbody> <tr> <td>TB2243A0</td> <td>D10 PE TRANSPAREN T PIPE</td> <td>3.000</td> <td>M</td> </tr> </tbody> </table>	Code	Description	Qty	UOM	TB2243A0	D10 PE TRANSPAREN T PIPE	3.000	M					
Code	Description	Qty	UOM										
TB2243A0	D10 PE TRANSPAREN T PIPE	3.000	M										
VL1135A	3/4-JG10 CONNECTOR + FILTER AND NRV		KVL1135A	3/4-JG10 FITTING WITH FILTER AND VNR KIT	<table border="1"> <thead> <tr> <th>Code</th> <th>Description</th> <th>Qty</th> <th>UOM</th> </tr> </thead> <tbody> <tr> <td>RC1360A0</td> <td>10 - 10 JG ELBOW FITTING</td> <td>1.000</td> <td>PC</td> </tr> </tbody> </table>	Code	Description	Qty	UOM	RC1360A0	10 - 10 JG ELBOW FITTING	1.000	PC
					Code	Description	Qty	UOM					
RC1360A0	10 - 10 JG ELBOW FITTING	1.000	PC										
<table border="1"> <thead> <tr> <th>Code</th> <th>Description</th> <th>Qty</th> <th>UOM</th> </tr> </thead> <tbody> <tr> <td>VL1135A1</td> <td>3/4-JG10 CONNECTOR + FILTER AND NRV</td> <td>1.000</td> <td>PC</td> </tr> </tbody> </table>	Code	Description	Qty	UOM	VL1135A1	3/4-JG10 CONNECTOR + FILTER AND NRV	1.000	PC					
Code	Description	Qty	UOM										
VL1135A1	3/4-JG10 CONNECTOR + FILTER AND NRV	1.000	PC										
RC1414A	D12 HOSE CLAMP		KRC1414A	D11-12 HOSE SNAP CLAMP 10 PCS KIT	<table border="1"> <thead> <tr> <th>Code</th> <th>Description</th> <th>Qty</th> <th>UOM</th> </tr> </thead> <tbody> <tr> <td>RC1414A0</td> <td>D12 HOSE CLAMP</td> <td>50.000</td> <td>PC</td> </tr> </tbody> </table>	Code	Description	Qty	UOM	RC1414A0	D12 HOSE CLAMP	50.000	PC
					Code	Description	Qty	UOM					
RC1414A0	D12 HOSE CLAMP	50.000	PC										
<table border="1"> <thead> <tr> <th>Code</th> <th>Description</th> <th>Qty</th> <th>UOM</th> </tr> </thead> <tbody> <tr> <td>VM1794A0</td> <td>250x4.8 PA66 BLACK CLAMP</td> <td>1.000</td> <td>PC</td> </tr> </tbody> </table>	Code	Description	Qty	UOM	VM1794A0	250x4.8 PA66 BLACK CLAMP	1.000	PC					
Code	Description	Qty	UOM										
VM1794A0	250x4.8 PA66 BLACK CLAMP	1.000	PC										
TB3251A	TB3131A-H2O STEAM INLET PIPE		KTB3131A	WHITE-BLACK 6X12 STEAM PIPE 3M KIT	<table border="1"> <thead> <tr> <th>Code</th> <th>Description</th> <th>Qty</th> <th>UOM</th> </tr> </thead> <tbody> <tr> <td>TB3131A0</td> <td>WHITE-BLACK EPDM TEXTILE BRAID HOSE 6x12</td> <td>3.000</td> <td>M</td> </tr> </tbody> </table>	Code	Description	Qty	UOM	TB3131A0	WHITE-BLACK EPDM TEXTILE BRAID HOSE 6x12	3.000	M
					Code	Description	Qty	UOM					
TB3131A0	WHITE-BLACK EPDM TEXTILE BRAID HOSE 6x12	3.000	M										
<table border="1"> <thead> <tr> <th>Code</th> <th>Description</th> <th>Qty</th> <th>UOM</th> </tr> </thead> <tbody> <tr> <td>VM1794A0</td> <td>250x4.8 PA66 BLACK CLAMP</td> <td>1.000</td> <td>PC</td> </tr> </tbody> </table>	Code	Description	Qty	UOM	VM1794A0	250x4.8 PA66 BLACK CLAMP	1.000	PC					
Code	Description	Qty	UOM										
VM1794A0	250x4.8 PA66 BLACK CLAMP	1.000	PC										
VL1086A	LIMESCALE REMOVER NEODYMIUM MAGNET		KVL1086A	NEODYMIUM MAGNET ANTI-LIMESCALE KI	<table border="1"> <thead> <tr> <th>Code</th> <th>Description</th> <th>Qty</th> <th>UOM</th> </tr> </thead> <tbody> <tr> <td>VL1086A0</td> <td>LIMESCALE REMOVER NEODYMIUM MAGNET</td> <td>2.000</td> <td>PC</td> </tr> </tbody> </table>	Code	Description	Qty	UOM	VL1086A0	LIMESCALE REMOVER NEODYMIUM MAGNET	2.000	PC
					Code	Description	Qty	UOM					
VL1086A0	LIMESCALE REMOVER NEODYMIUM MAGNET	2.000	PC										
<table border="1"> <thead> <tr> <th>Code</th> <th>Description</th> <th>Qty</th> <th>UOM</th> </tr> </thead> <tbody> <tr> <td>VM1794A0</td> <td>250x4.8 PA66 BLACK CLAMP</td> <td>1.000</td> <td>PC</td> </tr> </tbody> </table>	Code	Description	Qty	UOM	VM1794A0	250x4.8 PA66 BLACK CLAMP	1.000	PC					
Code	Description	Qty	UOM										
VM1794A0	250x4.8 PA66 BLACK CLAMP	1.000	PC										





COMPONENT			SPARE PART																																																																						
Code	Description	Image	Code	Description	Kit components																																																																				
VL1096A	2PCS T-SHAPED FIT-D6-D10 HOLD-MAGNET		KVL1096A	T - SHAPED FIT-D6-D10 HOLD-2 MAGNETS KIT	<table border="1"> <thead> <tr> <th>Code</th> <th>Description</th> <th>Qty</th> <th>UOM</th> </tr> </thead> <tbody> <tr> <td>RC1414A0</td> <td>D12 HOSE CLAMP</td> <td>2.000</td> <td>PC</td> </tr> <tr> <td>VL1086A0</td> <td>LIMESCALE REMOVER NEODYMIUM MAGNET</td> <td>2.000</td> <td>PC</td> </tr> <tr> <td>VL1096A1</td> <td>2PCS T-SHAPED FIT-D6-D10 HOLD-MAGNE</td> <td>1.000</td> <td>PC</td> </tr> </tbody> </table>	Code	Description	Qty	UOM	RC1414A0	D12 HOSE CLAMP	2.000	PC	VL1086A0	LIMESCALE REMOVER NEODYMIUM MAGNET	2.000	PC	VL1096A1	2PCS T-SHAPED FIT-D6-D10 HOLD-MAGNE	1.000	PC																																																				
					Code	Description	Qty	UOM																																																																	
RC1414A0	D12 HOSE CLAMP	2.000	PC																																																																						
VL1086A0	LIMESCALE REMOVER NEODYMIUM MAGNET	2.000	PC																																																																						
VL1096A1	2PCS T-SHAPED FIT-D6-D10 HOLD-MAGNE	1.000	PC																																																																						
<table border="1"> <thead> <tr> <th>Code</th> <th>Description</th> <th>Qty</th> <th>UOM</th> </tr> </thead> <tbody> <tr> <td>GN1400A0</td> <td>U-TRAP SEAL</td> <td>1.000</td> <td>PC</td> </tr> <tr> <td>VL1026A0</td> <td>BEND FOR DRAIN PIPE</td> <td>1.000</td> <td>PC</td> </tr> <tr> <td>VM2039A0</td> <td>DRAIN BEND FIXING RING</td> <td>1.000</td> <td>PC</td> </tr> </tbody> </table>	Code	Description	Qty	UOM	GN1400A0	U-TRAP SEAL	1.000	PC	VL1026A0	BEND FOR DRAIN PIPE	1.000	PC	VM2039A0	DRAIN BEND FIXING RING	1.000	PC																																																									
Code	Description	Qty	UOM																																																																						
GN1400A0	U-TRAP SEAL	1.000	PC																																																																						
VL1026A0	BEND FOR DRAIN PIPE	1.000	PC																																																																						
VM2039A0	DRAIN BEND FIXING RING	1.000	PC																																																																						
VL1026A	BEND FOR DRAIN PIPE		KVL1026A	DRAIN PIPE BEND KI	<table border="1"> <thead> <tr> <th>Code</th> <th>Description</th> <th>Qty</th> <th>UOM</th> </tr> </thead> <tbody> <tr> <td>GN1400A0</td> <td>U-TRAP SEAL</td> <td>1.000</td> <td>PC</td> </tr> <tr> <td>VL1026A0</td> <td>BEND FOR DRAIN PIPE</td> <td>1.000</td> <td>PC</td> </tr> <tr> <td>VM2039A0</td> <td>DRAIN BEND FIXING RING</td> <td>1.000</td> <td>PC</td> </tr> </tbody> </table>	Code	Description	Qty	UOM	GN1400A0	U-TRAP SEAL	1.000	PC	VL1026A0	BEND FOR DRAIN PIPE	1.000	PC	VM2039A0	DRAIN BEND FIXING RING	1.000	PC																																																				
Code	Description	Qty	UOM																																																																						
GN1400A0	U-TRAP SEAL	1.000	PC																																																																						
VL1026A0	BEND FOR DRAIN PIPE	1.000	PC																																																																						
VM2039A0	DRAIN BEND FIXING RING	1.000	PC																																																																						
VM2039A	DRAIN BEND FIXING RING		KVL1315A	CBX RECIRCULATION TANK KIT (NO PUMPS)	<table border="1"> <thead> <tr> <th>Code</th> <th>Description</th> <th>Qty</th> <th>UOM</th> </tr> </thead> <tbody> <tr> <td>0H6686A0</td> <td></td> <td>1.000</td> <td>PC</td> </tr> <tr> <td>GN1400A0</td> <td>U-TRAP SEAL</td> <td>1.000</td> <td>PC</td> </tr> <tr> <td>RC1019A0</td> <td>D=10 ELASTIC CLAMP</td> <td>2.000</td> <td>PC</td> </tr> <tr> <td>RC1243A0</td> <td>Ø10F-Ø10M ELBOW CONNECTION + JG END KIT</td> <td>1.000</td> <td>PC</td> </tr> <tr> <td>RC1360A0</td> <td>10 - 10 JG ELBOW FITTIN</td> <td>2.000</td> <td>PC</td> </tr> <tr> <td>RC1378A0</td> <td>HOSE CLAMP</td> <td>1.000</td> <td>PC</td> </tr> <tr> <td>RC1410A0</td> <td>ST STEEL HOSE CLAMP D16-27</td> <td>2.000</td> <td>PC</td> </tr> <tr> <td>SN1053A0</td> <td></td> <td>1.000</td> <td>PC</td> </tr> <tr> <td>SN1061A0</td> <td>D4x175MM NTC PROBE</td> <td>1.000</td> <td>PC</td> </tr> <tr> <td>TB3822A0</td> <td></td> <td>1.000</td> <td>PC</td> </tr> <tr> <td>TB4135A0</td> <td></td> <td>1.000</td> <td>PC</td> </tr> <tr> <td>TB4160A0</td> <td></td> <td>1.000</td> <td>PC</td> </tr> <tr> <td>VI1103A0</td> <td>40X12 TBSP SCREW FOR PLASTIC</td> <td>6.000</td> <td>PC</td> </tr> <tr> <td>VL1315A1</td> <td>ASM TANK BLOCK PUMPS DID</td> <td>1.000</td> <td>PC</td> </tr> <tr> <td>VL1340A0</td> <td>DID JG 10 M-M BYPASS CONNECTION</td> <td>1.000</td> <td>PC</td> </tr> <tr> <td>VL1400A0</td> <td>PARTIAL EDGE BENT DRAIN</td> <td>1.000</td> <td>PC</td> </tr> </tbody> </table>	Code	Description	Qty	UOM	0H6686A0		1.000	PC	GN1400A0	U-TRAP SEAL	1.000	PC	RC1019A0	D=10 ELASTIC CLAMP	2.000	PC	RC1243A0	Ø10F-Ø10M ELBOW CONNECTION + JG END KIT	1.000	PC	RC1360A0	10 - 10 JG ELBOW FITTIN	2.000	PC	RC1378A0	HOSE CLAMP	1.000	PC	RC1410A0	ST STEEL HOSE CLAMP D16-27	2.000	PC	SN1053A0		1.000	PC	SN1061A0	D4x175MM NTC PROBE	1.000	PC	TB3822A0		1.000	PC	TB4135A0		1.000	PC	TB4160A0		1.000	PC	VI1103A0	40X12 TBSP SCREW FOR PLASTIC	6.000	PC	VL1315A1	ASM TANK BLOCK PUMPS DID	1.000	PC	VL1340A0	DID JG 10 M-M BYPASS CONNECTION	1.000	PC	VL1400A0	PARTIAL EDGE BENT DRAIN	1.000	PC
					Code	Description	Qty	UOM																																																																	
0H6686A0		1.000	PC																																																																						
GN1400A0	U-TRAP SEAL	1.000	PC																																																																						
RC1019A0	D=10 ELASTIC CLAMP	2.000	PC																																																																						
RC1243A0	Ø10F-Ø10M ELBOW CONNECTION + JG END KIT	1.000	PC																																																																						
RC1360A0	10 - 10 JG ELBOW FITTIN	2.000	PC																																																																						
RC1378A0	HOSE CLAMP	1.000	PC																																																																						
RC1410A0	ST STEEL HOSE CLAMP D16-27	2.000	PC																																																																						
SN1053A0		1.000	PC																																																																						
SN1061A0	D4x175MM NTC PROBE	1.000	PC																																																																						
TB3822A0		1.000	PC																																																																						
TB4135A0		1.000	PC																																																																						
TB4160A0		1.000	PC																																																																						
VI1103A0	40X12 TBSP SCREW FOR PLASTIC	6.000	PC																																																																						
VL1315A1	ASM TANK BLOCK PUMPS DID	1.000	PC																																																																						
VL1340A0	DID JG 10 M-M BYPASS CONNECTION	1.000	PC																																																																						
VL1400A0	PARTIAL EDGE BENT DRAIN	1.000	PC																																																																						







COMPONENT			SPARE PART																																																																																							
Code	Description	Image	Code	Description	Kit components																																																																																					
VM2039A	DRAIN BEND FIXING RING		KVL1315A	CBX RECIRCULATION TANK KIT (NO PUMPS)	<table border="1"> <thead> <tr> <th>Code</th> <th>Description</th> <th>Qty</th> <th>UOM</th> </tr> </thead> <tbody> <tr> <td>VL1407A0</td> <td>DID PRESSURE REDUCER SET</td> <td>1.000</td> <td>PC</td> </tr> <tr> <td>VM1802A0</td> <td>DID TANKS FLAP PIN</td> <td>1.000</td> <td>PC</td> </tr> <tr> <td>VM2039A0</td> <td>DRAIN BEND FIXING RING</td> <td>1.000</td> <td>PC</td> </tr> <tr> <td>VM2640A0</td> <td>DRAIN PUMP PROTECTION</td> <td>1.000</td> <td>PC</td> </tr> </tbody> </table>	Code	Description	Qty	UOM	VL1407A0	DID PRESSURE REDUCER SET	1.000	PC	VM1802A0	DID TANKS FLAP PIN	1.000	PC	VM2039A0	DRAIN BEND FIXING RING	1.000	PC	VM2640A0	DRAIN PUMP PROTECTION	1.000	PC																																																																	
			Code		Description	Qty	UOM																																																																																			
VL1407A0	DID PRESSURE REDUCER SET	1.000	PC																																																																																							
VM1802A0	DID TANKS FLAP PIN	1.000	PC																																																																																							
VM2039A0	DRAIN BEND FIXING RING	1.000	PC																																																																																							
VM2640A0	DRAIN PUMP PROTECTION	1.000	PC																																																																																							
KVL1310A	COMPLETE CBX RECIRC TANK GROUP KIT	<table border="1"> <thead> <tr> <th>Code</th> <th>Description</th> <th>Qty</th> <th>UOM</th> </tr> </thead> <tbody> <tr> <td>0H5760A0</td> <td>CN1016 CAPACITOR COVER</td> <td>1.000</td> <td>PC</td> </tr> <tr> <td>0H6686A0</td> <td></td> <td>1.000</td> <td>PC</td> </tr> <tr> <td>CN1016A0</td> <td>CE/UL 500V 2.5 µF CAPACITO</td> <td>1.000</td> <td>PC</td> </tr> <tr> <td>GN1400A0</td> <td>U-TRAP SEAL</td> <td>1.000</td> <td>PC</td> </tr> <tr> <td>PM1013A0</td> <td>240V 32W DRAIN PUMP</td> <td>1.000</td> <td>PC</td> </tr> <tr> <td>PM1018A0</td> <td>240V 100W RECYCLING PUMP</td> <td>1.000</td> <td>PC</td> </tr> <tr> <td>RC1019A0</td> <td>D=10 ELASTIC CLAMP</td> <td>2.000</td> <td>PC</td> </tr> <tr> <td>RC1046A0</td> <td>D10-16 H9 ST STEEL HOSE CLAMP</td> <td>1.000</td> <td>PC</td> </tr> <tr> <td>RC1243A0</td> <td>Ø10F-Ø10M ELBOW CONNECTION + JG END KIT</td> <td>1.000</td> <td>PC</td> </tr> <tr> <td>RC1360A0</td> <td>10 - 10 JG ELBOW FITTIN</td> <td>2.000</td> <td>PC</td> </tr> <tr> <td>RC1378A0</td> <td>HOSE CLAMP</td> <td>1.000</td> <td>PC</td> </tr> <tr> <td>RC1410A0</td> <td>ST STEEL HOSE CLAMP D16-27</td> <td>6.000</td> <td>PC</td> </tr> <tr> <td>SN1053A0</td> <td></td> <td>1.000</td> <td>PC</td> </tr> <tr> <td>SN1061A0</td> <td>D4x175MM NTC PROBE</td> <td>1.000</td> <td>PC</td> </tr> <tr> <td>TB3822A0</td> <td></td> <td>2.000</td> <td>PC</td> </tr> <tr> <td>TB4135A0</td> <td></td> <td>1.000</td> <td>PC</td> </tr> <tr> <td>TB4160A0</td> <td></td> <td>1.000</td> <td>PC</td> </tr> <tr> <td>VI1103A0</td> <td>40X12 TBSP SCREW FOR PLASTIC</td> <td>9.000</td> <td>PC</td> </tr> <tr> <td>VI1220A1</td> <td>4,2x12 TCB SELF-TAPPIN G SCREW</td> <td>2.000</td> <td>PC</td> </tr> <tr> <td>VL1178A0</td> <td>EPDM O-RIN INNER D 10.8 STRING 1.78</td> <td>2.000</td> <td>PC</td> </tr> <tr> <td>VL1315A1</td> <td>ASM TANK BLOCK PUMPS DID</td> <td>1.000</td> <td>PC</td> </tr> </tbody> </table>	Code	Description	Qty	UOM	0H5760A0	CN1016 CAPACITOR COVER	1.000	PC	0H6686A0		1.000	PC	CN1016A0	CE/UL 500V 2.5 µF CAPACITO	1.000	PC	GN1400A0	U-TRAP SEAL	1.000	PC	PM1013A0	240V 32W DRAIN PUMP	1.000	PC	PM1018A0	240V 100W RECYCLING PUMP	1.000	PC	RC1019A0	D=10 ELASTIC CLAMP	2.000	PC	RC1046A0	D10-16 H9 ST STEEL HOSE CLAMP	1.000	PC	RC1243A0	Ø10F-Ø10M ELBOW CONNECTION + JG END KIT	1.000	PC	RC1360A0	10 - 10 JG ELBOW FITTIN	2.000	PC	RC1378A0	HOSE CLAMP	1.000	PC	RC1410A0	ST STEEL HOSE CLAMP D16-27	6.000	PC	SN1053A0		1.000	PC	SN1061A0	D4x175MM NTC PROBE	1.000	PC	TB3822A0		2.000	PC	TB4135A0		1.000	PC	TB4160A0		1.000	PC	VI1103A0	40X12 TBSP SCREW FOR PLASTIC	9.000	PC	VI1220A1	4,2x12 TCB SELF-TAPPIN G SCREW	2.000	PC	VL1178A0	EPDM O-RIN INNER D 10.8 STRING 1.78	2.000	PC	VL1315A1	ASM TANK BLOCK PUMPS DID	1.000	PC
Code	Description	Qty	UOM																																																																																							
0H5760A0	CN1016 CAPACITOR COVER	1.000	PC																																																																																							
0H6686A0		1.000	PC																																																																																							
CN1016A0	CE/UL 500V 2.5 µF CAPACITO	1.000	PC																																																																																							
GN1400A0	U-TRAP SEAL	1.000	PC																																																																																							
PM1013A0	240V 32W DRAIN PUMP	1.000	PC																																																																																							
PM1018A0	240V 100W RECYCLING PUMP	1.000	PC																																																																																							
RC1019A0	D=10 ELASTIC CLAMP	2.000	PC																																																																																							
RC1046A0	D10-16 H9 ST STEEL HOSE CLAMP	1.000	PC																																																																																							
RC1243A0	Ø10F-Ø10M ELBOW CONNECTION + JG END KIT	1.000	PC																																																																																							
RC1360A0	10 - 10 JG ELBOW FITTIN	2.000	PC																																																																																							
RC1378A0	HOSE CLAMP	1.000	PC																																																																																							
RC1410A0	ST STEEL HOSE CLAMP D16-27	6.000	PC																																																																																							
SN1053A0		1.000	PC																																																																																							
SN1061A0	D4x175MM NTC PROBE	1.000	PC																																																																																							
TB3822A0		2.000	PC																																																																																							
TB4135A0		1.000	PC																																																																																							
TB4160A0		1.000	PC																																																																																							
VI1103A0	40X12 TBSP SCREW FOR PLASTIC	9.000	PC																																																																																							
VI1220A1	4,2x12 TCB SELF-TAPPIN G SCREW	2.000	PC																																																																																							
VL1178A0	EPDM O-RIN INNER D 10.8 STRING 1.78	2.000	PC																																																																																							
VL1315A1	ASM TANK BLOCK PUMPS DID	1.000	PC																																																																																							



COMPONENT			SPARE PART																																														
Code	Description	Image	Code	Description	Kit components																																												
VM2039A	DRAIN BEND FIXING RING		KVL1310A	COMPLETE CBX RECIRC TANK GROUP KIT	<table border="1"> <thead> <tr> <th>Code</th> <th>Description</th> <th>Qty</th> <th>UOM</th> </tr> </thead> <tbody> <tr> <td>VL1318A0</td> <td>SUPPORTO POMPA RICIRCOLO DI</td> <td>1.000</td> <td>PC</td> </tr> <tr> <td>VL1329A0</td> <td>D24-D16 FITTING</td> <td>1.000</td> <td>PC</td> </tr> <tr> <td>VL1332A0</td> <td>DID TANK CAP</td> <td>1.000</td> <td>PC</td> </tr> <tr> <td>VL1340A0</td> <td>DID JG 10 M-M BYPASS CONNECTION</td> <td>1.000</td> <td>PC</td> </tr> <tr> <td>VL1400A0</td> <td>PARTIAL EDGE BENT DRAIN</td> <td>1.000</td> <td>PC</td> </tr> <tr> <td>VL1407A0</td> <td>DID PRESSURE REDUCER SET</td> <td>1.000</td> <td>PC</td> </tr> <tr> <td>VM1794A0</td> <td>250x4.8 PA66 BLACK CLAMP</td> <td>1.000</td> <td>PC</td> </tr> <tr> <td>VM1802A0</td> <td>DID TANKS FLAP PIN</td> <td>1.000</td> <td>PC</td> </tr> <tr> <td>VM2039A0</td> <td>DRAIN BEND FIXING RING</td> <td>1.000</td> <td>PC</td> </tr> <tr> <td>VM2640A0</td> <td>DRAIN PUMP PROTECTION</td> <td>1.000</td> <td>PC</td> </tr> </tbody> </table>	Code	Description	Qty	UOM	VL1318A0	SUPPORTO POMPA RICIRCOLO DI	1.000	PC	VL1329A0	D24-D16 FITTING	1.000	PC	VL1332A0	DID TANK CAP	1.000	PC	VL1340A0	DID JG 10 M-M BYPASS CONNECTION	1.000	PC	VL1400A0	PARTIAL EDGE BENT DRAIN	1.000	PC	VL1407A0	DID PRESSURE REDUCER SET	1.000	PC	VM1794A0	250x4.8 PA66 BLACK CLAMP	1.000	PC	VM1802A0	DID TANKS FLAP PIN	1.000	PC	VM2039A0	DRAIN BEND FIXING RING	1.000	PC	VM2640A0	DRAIN PUMP PROTECTION	1.000	PC
			Code	Description	Qty	UOM																																											
VL1318A0	SUPPORTO POMPA RICIRCOLO DI	1.000	PC																																														
VL1329A0	D24-D16 FITTING	1.000	PC																																														
VL1332A0	DID TANK CAP	1.000	PC																																														
VL1340A0	DID JG 10 M-M BYPASS CONNECTION	1.000	PC																																														
VL1400A0	PARTIAL EDGE BENT DRAIN	1.000	PC																																														
VL1407A0	DID PRESSURE REDUCER SET	1.000	PC																																														
VM1794A0	250x4.8 PA66 BLACK CLAMP	1.000	PC																																														
VM1802A0	DID TANKS FLAP PIN	1.000	PC																																														
VM2039A0	DRAIN BEND FIXING RING	1.000	PC																																														
VM2640A0	DRAIN PUMP PROTECTION	1.000	PC																																														
KVL1026A	DRAIN PIPE BEND KI	<table border="1"> <thead> <tr> <th>Code</th> <th>Description</th> <th>Qty</th> <th>UOM</th> </tr> </thead> <tbody> <tr> <td>GN1400A0</td> <td>U-TRAP SEAL</td> <td>1.000</td> <td>PC</td> </tr> <tr> <td>VL1026A0</td> <td>BEND FOR DRAIN PIPE</td> <td>1.000</td> <td>PC</td> </tr> <tr> <td>VM2039A0</td> <td>DRAIN BEND FIXING RING</td> <td>1.000</td> <td>PC</td> </tr> </tbody> </table>	Code	Description	Qty	UOM	GN1400A0	U-TRAP SEAL	1.000	PC	VL1026A0	BEND FOR DRAIN PIPE	1.000	PC	VM2039A0	DRAIN BEND FIXING RING	1.000	PC																															
Code	Description	Qty	UOM																																														
GN1400A0	U-TRAP SEAL	1.000	PC																																														
VL1026A0	BEND FOR DRAIN PIPE	1.000	PC																																														
VM2039A0	DRAIN BEND FIXING RING	1.000	PC																																														
VM1555A	CT BT COOLING FAN SUPPORT		KVN1165A	S.5E ADVANCE/MM 230V COOLING FAN KIT	<table border="1"> <thead> <tr> <th>Code</th> <th>Description</th> <th>Qty</th> <th>UOM</th> </tr> </thead> <tbody> <tr> <td>VI1099A0</td> <td>SELF-DRILLIN G SCREW 4.8X13 TCB+ Z</td> <td>4.000</td> <td>PC</td> </tr> <tr> <td>VM1555A2</td> <td>CT BT COOLING FAN SUPPORT</td> <td>1.000</td> <td>PC</td> </tr> <tr> <td>VN1165A0</td> <td>230Vac 50/60Hz COOLING DOWN FAN</td> <td>1.000</td> <td>PC</td> </tr> </tbody> </table>	Code	Description	Qty	UOM	VI1099A0	SELF-DRILLIN G SCREW 4.8X13 TCB+ Z	4.000	PC	VM1555A2	CT BT COOLING FAN SUPPORT	1.000	PC	VN1165A0	230Vac 50/60Hz COOLING DOWN FAN	1.000	PC																												
			Code	Description	Qty	UOM																																											
VI1099A0	SELF-DRILLIN G SCREW 4.8X13 TCB+ Z	4.000	PC																																														
VM1555A2	CT BT COOLING FAN SUPPORT	1.000	PC																																														
VN1165A0	230Vac 50/60Hz COOLING DOWN FAN	1.000	PC																																														
KVN1164A	S.5/5E 12VDC COOLING DOWN FAN KIT	<table border="1"> <thead> <tr> <th>Code</th> <th>Description</th> <th>Qty</th> <th>UOM</th> </tr> </thead> <tbody> <tr> <td>VI1099A0</td> <td>SELF-DRILLIN G SCREW 4.8X13 TCB+ Z</td> <td>4.000</td> <td>PC</td> </tr> <tr> <td>VM1555A2</td> <td>CT BT COOLING FAN SUPPORT</td> <td>1.000</td> <td>PC</td> </tr> <tr> <td>VN1164A0</td> <td>12VDC COOLING DOWN FAN</td> <td>1.000</td> <td>PC</td> </tr> </tbody> </table>	Code	Description	Qty	UOM	VI1099A0	SELF-DRILLIN G SCREW 4.8X13 TCB+ Z	4.000	PC	VM1555A2	CT BT COOLING FAN SUPPORT	1.000	PC	VN1164A0	12VDC COOLING DOWN FAN	1.000	PC																															
Code	Description	Qty	UOM																																														
VI1099A0	SELF-DRILLIN G SCREW 4.8X13 TCB+ Z	4.000	PC																																														
VM1555A2	CT BT COOLING FAN SUPPORT	1.000	PC																																														
VN1164A0	12VDC COOLING DOWN FAN	1.000	PC																																														

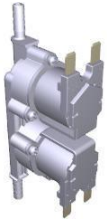
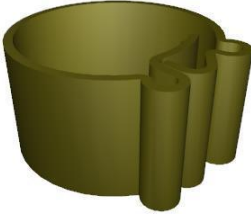



COMPONENT			SPARE PART																		
Code	Description	Image	Code	Description	Kit components																
VM1556A	XBC-XVC COOLING FAN GUARD		KVM1556A	XBC-XVC COOLING FAN GUARD KIT	<table border="1"> <thead> <tr> <th>Code</th> <th>Description</th> <th>Qty</th> <th>UOM</th> </tr> </thead> <tbody> <tr> <td>VM1556A0</td> <td>XBC-XVC COOLING FAN GUARD</td> <td>1.000</td> <td>PC</td> </tr> </tbody> </table>	Code	Description	Qty	UOM	VM1556A0	XBC-XVC COOLING FAN GUARD	1.000	PC								
Code	Description	Qty	UOM																		
VM1556A0	XBC-XVC COOLING FAN GUARD	1.000	PC																		
VN1165A	230Vac 50/60Hz COOLING DOWN FA		KVN1165A	S.5E ADVANCE/MM 230V COOLING FAN KIT	<table border="1"> <thead> <tr> <th>Code</th> <th>Description</th> <th>Qty</th> <th>UOM</th> </tr> </thead> <tbody> <tr> <td>V11099A0</td> <td>SELF-DRILLIN G SCREW 4.8X13 TCB+ Z</td> <td>4.000</td> <td>PC</td> </tr> <tr> <td>VM1555A2</td> <td>CT BT COOLING FAN SUPPORT</td> <td>1.000</td> <td>PC</td> </tr> <tr> <td>VN1165A0</td> <td>230Vac 50/60Hz COOLING DOWN FAN</td> <td>1.000</td> <td>PC</td> </tr> </tbody> </table>	Code	Description	Qty	UOM	V11099A0	SELF-DRILLIN G SCREW 4.8X13 TCB+ Z	4.000	PC	VM1555A2	CT BT COOLING FAN SUPPORT	1.000	PC	VN1165A0	230Vac 50/60Hz COOLING DOWN FAN	1.000	PC
Code	Description	Qty	UOM																		
V11099A0	SELF-DRILLIN G SCREW 4.8X13 TCB+ Z	4.000	PC																		
VM1555A2	CT BT COOLING FAN SUPPORT	1.000	PC																		
VN1165A0	230Vac 50/60Hz COOLING DOWN FAN	1.000	PC																		
EL1438A	BARBED STEAM SOLENOID VALVE 5+9		KEL1438A	5+9 BARBED 6 STEAM SOLENOID VALVE KIT	<table border="1"> <thead> <tr> <th>Code</th> <th>Description</th> <th>Qty</th> <th>UOM</th> </tr> </thead> <tbody> <tr> <td>EL1438A0</td> <td>BARBED STEAM SOLENOID VALVE 5+9</td> <td>1.000</td> <td>PC</td> </tr> <tr> <td>RC1414A0</td> <td>D12 HOSE CLAMP</td> <td>2.000</td> <td>PC</td> </tr> </tbody> </table>	Code	Description	Qty	UOM	EL1438A0	BARBED STEAM SOLENOID VALVE 5+9	1.000	PC	RC1414A0	D12 HOSE CLAMP	2.000	PC				
Code	Description	Qty	UOM																		
EL1438A0	BARBED STEAM SOLENOID VALVE 5+9	1.000	PC																		
RC1414A0	D12 HOSE CLAMP	2.000	PC																		
RC1414A	D12 HOSE CLAMP		KRC1414A	D11-12 HOSE SNAP CLAMP 10 PCS KIT	<table border="1"> <thead> <tr> <th>Code</th> <th>Description</th> <th>Qty</th> <th>UOM</th> </tr> </thead> <tbody> <tr> <td>RC1414A0</td> <td>D12 HOSE CLAMP</td> <td>50.000</td> <td>PC</td> </tr> </tbody> </table>	Code	Description	Qty	UOM	RC1414A0	D12 HOSE CLAMP	50.000	PC								
Code	Description	Qty	UOM																		
RC1414A0	D12 HOSE CLAMP	50.000	PC																		
TB3284A	TB3131A-830MM 6x12 WHITE-BLACK EPDM HOSE		TB3284A0	TB3131A-830MM 6x12 WHITE-BLACK EPDM HOSE																	



COMPONENT			SPARE PART																																																																																		
Code	Description	Image	Code	Description	Kit components																																																																																
VL1183A	EU PLUS 1 ROTOR ARM WASHING CIRCUIT		KVL1183A	1 ROTOR ARM PLUS CLEANING SYSTEM KIT	<table border="1"> <thead> <tr> <th>Code</th> <th>Description</th> <th>Qty</th> <th>UOM</th> </tr> </thead> <tbody> <tr> <td>0H2354A1</td> <td>XEVC-XEVL PLUS WASHING CIRCUIT PLAT</td> <td>1.000</td> <td>PC</td> </tr> <tr> <td>EL1440A0</td> <td>WATER SELF CLEANING VALVE</td> <td>3.000</td> <td>PC</td> </tr> <tr> <td>GN1526A0</td> <td>INT. D.=6.9 TH=1.8 O-RIN</td> <td>7.000</td> <td>PC</td> </tr> <tr> <td>RC1018A0</td> <td>ZINC PLATED D12 ELASTIC CLAMP</td> <td>2.000</td> <td>PC</td> </tr> <tr> <td>RC1019A0</td> <td>D=10 ELASTIC CLAMP</td> <td>14.000</td> <td>PC</td> </tr> <tr> <td>RC1130A0</td> <td>130x2.6 CLAM</td> <td>1.000</td> <td>PC</td> </tr> <tr> <td>RC1131A0</td> <td>200x2.6 BLACK CLAMP</td> <td>2.000</td> <td>PC</td> </tr> <tr> <td>RC1242A0</td> <td>D=10 CLOSED CAP</td> <td>2.000</td> <td>PC</td> </tr> <tr> <td>RC1356A0</td> <td>"STRAIGHT THREADED FEMALE END 8x1/4" BS</td> <td>1.000</td> <td>PC</td> </tr> <tr> <td>TB2821A0</td> <td>EPDM 6X10 L=40MM PIPE</td> <td>6.000</td> <td>PC</td> </tr> <tr> <td>TB3004A0</td> <td>TB2820A L=550mm EPDM BLACK PIPE</td> <td>1.000</td> <td>PC</td> </tr> <tr> <td>TB3005B0</td> <td>TB3132A L=550mm EPDM WHITE-BLUE PIPE</td> <td>1.000</td> <td>PC</td> </tr> <tr> <td>TB3225B0</td> <td>TB2820A-TAN K-WASHYNG SYS CONNECTION</td> <td>1.000</td> <td>PC</td> </tr> <tr> <td>TB3252A0</td> <td>TB3252A0</td> <td>1.000</td> <td>PC</td> </tr> <tr> <td>VL1019A0</td> <td>VIBRATION DETERGENT PUMP</td> <td>1.000</td> <td>PC</td> </tr> <tr> <td>VL1047A1</td> <td>D6 PIPE HOLDER - D8 J.G. TERMINAL</td> <td>1.000</td> <td>PC</td> </tr> <tr> <td>VL1065A1</td> <td>1/4 MALE N.O. PRESSURE SWITCH</td> <td>1.000</td> <td>PC</td> </tr> <tr> <td>VL1102A1</td> <td>DETERGENT LINE FILTER + BARBED VNR 6 MM</td> <td>1.000</td> <td>PC</td> </tr> <tr> <td>VL1128A1</td> <td>D6 BARBED CHECK VALVE</td> <td>2.000</td> <td>PC</td> </tr> </tbody> </table>	Code	Description	Qty	UOM	0H2354A1	XEVC-XEVL PLUS WASHING CIRCUIT PLAT	1.000	PC	EL1440A0	WATER SELF CLEANING VALVE	3.000	PC	GN1526A0	INT. D.=6.9 TH=1.8 O-RIN	7.000	PC	RC1018A0	ZINC PLATED D12 ELASTIC CLAMP	2.000	PC	RC1019A0	D=10 ELASTIC CLAMP	14.000	PC	RC1130A0	130x2.6 CLAM	1.000	PC	RC1131A0	200x2.6 BLACK CLAMP	2.000	PC	RC1242A0	D=10 CLOSED CAP	2.000	PC	RC1356A0	"STRAIGHT THREADED FEMALE END 8x1/4" BS	1.000	PC	TB2821A0	EPDM 6X10 L=40MM PIPE	6.000	PC	TB3004A0	TB2820A L=550mm EPDM BLACK PIPE	1.000	PC	TB3005B0	TB3132A L=550mm EPDM WHITE-BLUE PIPE	1.000	PC	TB3225B0	TB2820A-TAN K-WASHYNG SYS CONNECTION	1.000	PC	TB3252A0	TB3252A0	1.000	PC	VL1019A0	VIBRATION DETERGENT PUMP	1.000	PC	VL1047A1	D6 PIPE HOLDER - D8 J.G. TERMINAL	1.000	PC	VL1065A1	1/4 MALE N.O. PRESSURE SWITCH	1.000	PC	VL1102A1	DETERGENT LINE FILTER + BARBED VNR 6 MM	1.000	PC	VL1128A1	D6 BARBED CHECK VALVE	2.000	PC
Code	Description	Qty	UOM																																																																																		
0H2354A1	XEVC-XEVL PLUS WASHING CIRCUIT PLAT	1.000	PC																																																																																		
EL1440A0	WATER SELF CLEANING VALVE	3.000	PC																																																																																		
GN1526A0	INT. D.=6.9 TH=1.8 O-RIN	7.000	PC																																																																																		
RC1018A0	ZINC PLATED D12 ELASTIC CLAMP	2.000	PC																																																																																		
RC1019A0	D=10 ELASTIC CLAMP	14.000	PC																																																																																		
RC1130A0	130x2.6 CLAM	1.000	PC																																																																																		
RC1131A0	200x2.6 BLACK CLAMP	2.000	PC																																																																																		
RC1242A0	D=10 CLOSED CAP	2.000	PC																																																																																		
RC1356A0	"STRAIGHT THREADED FEMALE END 8x1/4" BS	1.000	PC																																																																																		
TB2821A0	EPDM 6X10 L=40MM PIPE	6.000	PC																																																																																		
TB3004A0	TB2820A L=550mm EPDM BLACK PIPE	1.000	PC																																																																																		
TB3005B0	TB3132A L=550mm EPDM WHITE-BLUE PIPE	1.000	PC																																																																																		
TB3225B0	TB2820A-TAN K-WASHYNG SYS CONNECTION	1.000	PC																																																																																		
TB3252A0	TB3252A0	1.000	PC																																																																																		
VL1019A0	VIBRATION DETERGENT PUMP	1.000	PC																																																																																		
VL1047A1	D6 PIPE HOLDER - D8 J.G. TERMINAL	1.000	PC																																																																																		
VL1065A1	1/4 MALE N.O. PRESSURE SWITCH	1.000	PC																																																																																		
VL1102A1	DETERGENT LINE FILTER + BARBED VNR 6 MM	1.000	PC																																																																																		
VL1128A1	D6 BARBED CHECK VALVE	2.000	PC																																																																																		



COMPONENT			SPARE PART																																																										
Code	Description	Image	Code	Description	Kit components																																																								
VL1183A	EU PLUS 1 ROTOR ARM WASHING CIRCUIT		KVL1183A	1 ROTOR ARM PLUS CLEANING SYSTEM KIT	<table border="1"> <thead> <tr> <th>Code</th> <th>Description</th> <th>Qty</th> <th>UOM</th> </tr> </thead> <tbody> <tr> <td>VL1166A0</td> <td>BB6-AR6 L FITTING</td> <td>3.000</td> <td>PC</td> </tr> <tr> <td>VL1174C0</td> <td>D1.2 MM CALIBRATED D1.2 MM</td> <td>1.000</td> <td>PC</td> </tr> <tr> <td>VL1185A0</td> <td>2 WAYS PLUS WASHING DISTRIBUTOR</td> <td>1.000</td> <td>PC</td> </tr> <tr> <td>VL1190A0</td> <td>PLUS WASHING SYSTEM INLET DISTRIBUTOR</td> <td>1.000</td> <td>PC</td> </tr> <tr> <td>VL1214A0</td> <td>BAYONET - 6mm BARBED NRV VALVE</td> <td>1.000</td> <td>PC</td> </tr> <tr> <td>VM1605A0</td> <td>CLIP TWIST LOCK DIAM. 10,2-12,7 MM</td> <td>3.000</td> <td>PC</td> </tr> <tr> <td>VM2172A0</td> <td>LOCKING CLIP FOR PUMP WITH CIRCUIT</td> <td>4.000</td> <td>PC</td> </tr> </tbody> </table>	Code	Description	Qty	UOM	VL1166A0	BB6-AR6 L FITTING	3.000	PC	VL1174C0	D1.2 MM CALIBRATED D1.2 MM	1.000	PC	VL1185A0	2 WAYS PLUS WASHING DISTRIBUTOR	1.000	PC	VL1190A0	PLUS WASHING SYSTEM INLET DISTRIBUTOR	1.000	PC	VL1214A0	BAYONET - 6mm BARBED NRV VALVE	1.000	PC	VM1605A0	CLIP TWIST LOCK DIAM. 10,2-12,7 MM	3.000	PC	VM2172A0	LOCKING CLIP FOR PUMP WITH CIRCUIT	4.000	PC																								
					Code	Description	Qty	UOM																																																					
					VL1166A0	BB6-AR6 L FITTING	3.000	PC																																																					
					VL1174C0	D1.2 MM CALIBRATED D1.2 MM	1.000	PC																																																					
					VL1185A0	2 WAYS PLUS WASHING DISTRIBUTOR	1.000	PC																																																					
					VL1190A0	PLUS WASHING SYSTEM INLET DISTRIBUTOR	1.000	PC																																																					
					VL1214A0	BAYONET - 6mm BARBED NRV VALVE	1.000	PC																																																					
					VM1605A0	CLIP TWIST LOCK DIAM. 10,2-12,7 MM	3.000	PC																																																					
VM2172A0	LOCKING CLIP FOR PUMP WITH CIRCUIT	4.000	PC																																																										
0H2354A	XEVC-XEVL PLUS WASHING CIRCUIT PLATE		KVL1209A	US PLUS 3 ROTOR ARMS WASHING SYSTEM KIT	<table border="1"> <thead> <tr> <th>Code</th> <th>Description</th> <th>Qty</th> <th>UOM</th> </tr> </thead> <tbody> <tr> <td>0H2354A1</td> <td>XEVC-XEVL PLUS WASHING CIRCUIT PLAT</td> <td>1.000</td> <td>PC</td> </tr> <tr> <td>EL1450A0</td> <td>US SELF-CLEANING WATER SOLENOID</td> <td>4.000</td> <td>PC</td> </tr> <tr> <td>GN1526A0</td> <td>INT. D.=6.9 TH=1.8 O-RING</td> <td>9.000</td> <td>PC</td> </tr> <tr> <td>RC1018A0</td> <td>ZINC PLATED D12 ELASTIC CLAMP</td> <td>12.000</td> <td>PC</td> </tr> <tr> <td>RC1019A0</td> <td>D=10 ELASTIC CLAMP</td> <td>15.000</td> <td>PC</td> </tr> <tr> <td>RC1130A0</td> <td>130x2.6 CLAMP</td> <td>1.000</td> <td>PC</td> </tr> <tr> <td>RC1131A0</td> <td>200x2.6 BLACK CLAMP</td> <td>3.000</td> <td>PC</td> </tr> <tr> <td>RC1242A0</td> <td>D=10 CLOSED CAP</td> <td>2.000</td> <td>PC</td> </tr> <tr> <td>RC1356A0</td> <td>"STRAIGHT THREADED FEMALE END 8x1/4" BS</td> <td>1.000</td> <td>PC</td> </tr> <tr> <td>TB2652A0</td> <td></td> <td>1.000</td> <td>PC</td> </tr> <tr> <td>TB2677A0</td> <td></td> <td>1.000</td> <td>PC</td> </tr> <tr> <td>TB2821A0</td> <td>EPDM 6X10 L=40MM PIPE</td> <td>6.000</td> <td>PC</td> </tr> <tr> <td>TB3004A0</td> <td>TB2820A L=550mm EPDM BLACK PIPE</td> <td>2.000</td> <td>PC</td> </tr> </tbody> </table>	Code	Description	Qty	UOM	0H2354A1	XEVC-XEVL PLUS WASHING CIRCUIT PLAT	1.000	PC	EL1450A0	US SELF-CLEANING WATER SOLENOID	4.000	PC	GN1526A0	INT. D.=6.9 TH=1.8 O-RING	9.000	PC	RC1018A0	ZINC PLATED D12 ELASTIC CLAMP	12.000	PC	RC1019A0	D=10 ELASTIC CLAMP	15.000	PC	RC1130A0	130x2.6 CLAMP	1.000	PC	RC1131A0	200x2.6 BLACK CLAMP	3.000	PC	RC1242A0	D=10 CLOSED CAP	2.000	PC	RC1356A0	"STRAIGHT THREADED FEMALE END 8x1/4" BS	1.000	PC	TB2652A0		1.000	PC	TB2677A0		1.000	PC	TB2821A0	EPDM 6X10 L=40MM PIPE	6.000	PC	TB3004A0	TB2820A L=550mm EPDM BLACK PIPE	2.000	PC
					Code	Description	Qty	UOM																																																					
					0H2354A1	XEVC-XEVL PLUS WASHING CIRCUIT PLAT	1.000	PC																																																					
					EL1450A0	US SELF-CLEANING WATER SOLENOID	4.000	PC																																																					
					GN1526A0	INT. D.=6.9 TH=1.8 O-RING	9.000	PC																																																					
					RC1018A0	ZINC PLATED D12 ELASTIC CLAMP	12.000	PC																																																					
					RC1019A0	D=10 ELASTIC CLAMP	15.000	PC																																																					
					RC1130A0	130x2.6 CLAMP	1.000	PC																																																					
					RC1131A0	200x2.6 BLACK CLAMP	3.000	PC																																																					
					RC1242A0	D=10 CLOSED CAP	2.000	PC																																																					
					RC1356A0	"STRAIGHT THREADED FEMALE END 8x1/4" BS	1.000	PC																																																					
					TB2652A0		1.000	PC																																																					
					TB2677A0		1.000	PC																																																					
					TB2821A0	EPDM 6X10 L=40MM PIPE	6.000	PC																																																					
					TB3004A0	TB2820A L=550mm EPDM BLACK PIPE	2.000	PC																																																					



COMPONENT			SPARE PART					
Code	Description	Image	Code	Description	Kit components			
0H2354A	XEVC-XEVL PLUS WASHING CIRCUIT PLATE		KVL1209A	US PLUS 3 ROTOR ARMS WASHING SYSTEM KIT	Code	Description	Qty	UOM
					TB3024C0		3.000	PC
					TB3226A0		1.000	PC
					TB3440A0	TB3132A L=1050mm EPDM WHITE-BLUE PIPE	1.000	PC
					VL1019A0	VIBRATION DETERGENT PUMP	1.000	PC
					VL1065A1	1/4 MALE N.O. PRESSURE SWITCH	1.000	PC
					VL1102A1	DETERGENT LINE FILTER + BARBED VNR 6 MM	1.000	PC
					VL1127A1	6mm BARBED T-SHAPED FITTING	2.000	PC
					VL1128A1	D6 BARBED CHECK VALVE	3.000	PC
					VL1166A0	BB6-AR6 L FITTING	4.000	PC
					VL1167A2	GN21 3 ROTOR ARMS B-B FLOW RESTRICTOR	1.000	PC
					VL1174C0	D1.2 MM CALIBRATED D1.2 MM	1.000	PC
					VL1185A0	2 WAYS PLUS WASHING DISTRIBUTOR	1.000	PC
					VL1186A0	3 WAYS PLUS WASHING DISTRIBUTOR	1.000	PC
					VL1190A0	PLUS WASHING SYSTEM INLET DISTRIBUTOR	1.000	PC
					VL1214A0	BAYONET - 6mm BARBED NRV VALVE	1.000	PC
					VM1605A0	CLIP TWIST LOCK DIAM. 10,2-12,7 MM	3.000	PC
					VM2172A0	LOCKING CLIP FOR PUMP WITH CIRCUIT	9.000	PC



COMPONENT			SPARE PART					
Code	Description	Image	Code	Description	Kit components			
0H2354A	XEVC-XEVL PLUS WASHING CIRCUIT PLATE		KVL1208A	US PLUS 2 ROTOR ARMS WASHING SYSTEM KIT	Code	Description	Qty	UOM
					0H2354A1	XEVC-XEVL PLUS WASHING CIRCUIT PLAT	1.000	PC
					EL1450A0	US SELF-CLEANIN G WATER SOLENOID	4.000	PC
					GN1526A0	INT. D.=6.9 TH=1.8 O-RIN	9.000	PC
					RC1018A0	ZINC PLATED D12 ELASTIC CLAMP	3.000	PC
					RC1019A0	D=10 ELASTIC CLAMP	2.000	PC
					RC1130A0	130x2.6 CLAM	1.000	PC
					RC1131A0	200x2.6 BLACK CLAMP	3.000	PC
					RC1242A0	D=10 CLOSED CAP	2.000	PC
					RC1356A0	*STRAIGHT THREADED FEMALE END 8x1/4" BS	1.000	PC
					TB2821A0	EPDM 6X10 L=40MM PIPE	6.000	PC
					TB2994A0	HOOD DETERGENT PIPE	1.000	PC
					TB3004A0	TB2820A L=550mm EPDM BLACK PIPE	1.000	PC
					TB3005B0	TB3132A L=550mm EPDM WHITE-BLUE PIPE	1.000	PC
					TB3440A0	TB3132A L=1050mm EPDM WHITE-BLUE PIPE	1.000	PC
					VL1019A0	VIBRATION DETERGENT PUMP	1.000	PC
					VL1047A1	D6 PIPE HOLDER - D8 J.G. TERMINAL	1.000	PC
					VL1065A1	1/4 MALE N.O. PRESSURE SWITCH	1.000	PC



COMPONENT			SPARE PART																																														
Code	Description	Image	Code	Description	Kit components																																												
0H2354A	XEVC-XEVL PLUS WASHING CIRCUIT PLATE		KVL1208A	US PLUS 2 ROTOR ARMS WASHING SYSTEM KIT	<table border="1"> <thead> <tr> <th>Code</th> <th>Description</th> <th>Qty</th> <th>UOM</th> </tr> </thead> <tbody> <tr> <td>VL1102A1</td> <td>DETERGENT LINE FILTER + BARBED VNR 6 MM</td> <td>1.000</td> <td>PC</td> </tr> <tr> <td>VL1128A1</td> <td>D6 BARBED CHECK VALVE</td> <td>2.000</td> <td>PC</td> </tr> <tr> <td>VL1141A1</td> <td>BB6-BB6 STRAIGHT CONNECTION</td> <td>1.000</td> <td>PC</td> </tr> <tr> <td>VL1166A0</td> <td>BB6-AR6 L FITTING</td> <td>4.000</td> <td>PC</td> </tr> <tr> <td>VL1174C0</td> <td>D1.2 MM CALIBRATED D1.2 MM</td> <td>1.000</td> <td>PC</td> </tr> <tr> <td>VL1186A0</td> <td>3 WAYS PLUS WASHING DISTRIBUTOR</td> <td>1.000</td> <td>PC</td> </tr> <tr> <td>VL1190A0</td> <td>PLUS WASHING SYSTEM INLET DISTRIBUTOR</td> <td>1.000</td> <td>PC</td> </tr> <tr> <td>VL1214A0</td> <td>BAYONET - 6mm BARBED NRV VALVE</td> <td>1.000</td> <td>PC</td> </tr> <tr> <td>VM1605A0</td> <td>CLIP TWIST LOCK DIAM. 10,2-12,7 MM</td> <td>3.000</td> <td>PC</td> </tr> <tr> <td>VM2172A0</td> <td>LOCKING CLIP FOR PUMP WITH CIRCUIT</td> <td>5.000</td> <td>PC</td> </tr> </tbody> </table>	Code	Description	Qty	UOM	VL1102A1	DETERGENT LINE FILTER + BARBED VNR 6 MM	1.000	PC	VL1128A1	D6 BARBED CHECK VALVE	2.000	PC	VL1141A1	BB6-BB6 STRAIGHT CONNECTION	1.000	PC	VL1166A0	BB6-AR6 L FITTING	4.000	PC	VL1174C0	D1.2 MM CALIBRATED D1.2 MM	1.000	PC	VL1186A0	3 WAYS PLUS WASHING DISTRIBUTOR	1.000	PC	VL1190A0	PLUS WASHING SYSTEM INLET DISTRIBUTOR	1.000	PC	VL1214A0	BAYONET - 6mm BARBED NRV VALVE	1.000	PC	VM1605A0	CLIP TWIST LOCK DIAM. 10,2-12,7 MM	3.000	PC	VM2172A0	LOCKING CLIP FOR PUMP WITH CIRCUIT	5.000	PC
			Code	Description	Qty	UOM																																											
VL1102A1	DETERGENT LINE FILTER + BARBED VNR 6 MM	1.000	PC																																														
VL1128A1	D6 BARBED CHECK VALVE	2.000	PC																																														
VL1141A1	BB6-BB6 STRAIGHT CONNECTION	1.000	PC																																														
VL1166A0	BB6-AR6 L FITTING	4.000	PC																																														
VL1174C0	D1.2 MM CALIBRATED D1.2 MM	1.000	PC																																														
VL1186A0	3 WAYS PLUS WASHING DISTRIBUTOR	1.000	PC																																														
VL1190A0	PLUS WASHING SYSTEM INLET DISTRIBUTOR	1.000	PC																																														
VL1214A0	BAYONET - 6mm BARBED NRV VALVE	1.000	PC																																														
VM1605A0	CLIP TWIST LOCK DIAM. 10,2-12,7 MM	3.000	PC																																														
VM2172A0	LOCKING CLIP FOR PUMP WITH CIRCUIT	5.000	PC																																														
KVL1207A	US PLUS 1 ROTOR ARM WASHING SYSTEM KIT	<table border="1"> <thead> <tr> <th>Code</th> <th>Description</th> <th>Qty</th> <th>UOM</th> </tr> </thead> <tbody> <tr> <td>0H2354A1</td> <td>XEVC-XEVL PLUS WASHING CIRCUIT PLAT</td> <td>1.000</td> <td>PC</td> </tr> <tr> <td>EL1450A0</td> <td>US SELF-CLEANING WATER SOLENOID</td> <td>3.000</td> <td>PC</td> </tr> <tr> <td>GN1526A0</td> <td>INT. D.=6.9 TH=1.8 O-RIN</td> <td>7.000</td> <td>PC</td> </tr> <tr> <td>RC1018A0</td> <td>ZINC PLATED D12 ELASTIC CLAMP</td> <td>2.000</td> <td>PC</td> </tr> <tr> <td>RC1019A0</td> <td>D=10 ELASTIC CLAMP</td> <td>14.000</td> <td>PC</td> </tr> <tr> <td>RC1130A0</td> <td>130x2.6 CLAM</td> <td>1.000</td> <td>PC</td> </tr> <tr> <td>RC1131A0</td> <td>200x2.6 BLACK CLAMP</td> <td>2.000</td> <td>PC</td> </tr> <tr> <td>RC1242A0</td> <td>D=10 CLOSED CAP</td> <td>2.000</td> <td>PC</td> </tr> </tbody> </table>	Code	Description	Qty	UOM	0H2354A1	XEVC-XEVL PLUS WASHING CIRCUIT PLAT	1.000	PC	EL1450A0	US SELF-CLEANING WATER SOLENOID	3.000	PC	GN1526A0	INT. D.=6.9 TH=1.8 O-RIN	7.000	PC	RC1018A0	ZINC PLATED D12 ELASTIC CLAMP	2.000	PC	RC1019A0	D=10 ELASTIC CLAMP	14.000	PC	RC1130A0	130x2.6 CLAM	1.000	PC	RC1131A0	200x2.6 BLACK CLAMP	2.000	PC	RC1242A0	D=10 CLOSED CAP	2.000	PC											
Code	Description	Qty	UOM																																														
0H2354A1	XEVC-XEVL PLUS WASHING CIRCUIT PLAT	1.000	PC																																														
EL1450A0	US SELF-CLEANING WATER SOLENOID	3.000	PC																																														
GN1526A0	INT. D.=6.9 TH=1.8 O-RIN	7.000	PC																																														
RC1018A0	ZINC PLATED D12 ELASTIC CLAMP	2.000	PC																																														
RC1019A0	D=10 ELASTIC CLAMP	14.000	PC																																														
RC1130A0	130x2.6 CLAM	1.000	PC																																														
RC1131A0	200x2.6 BLACK CLAMP	2.000	PC																																														
RC1242A0	D=10 CLOSED CAP	2.000	PC																																														



COMPONENT			SPARE PART			
Code	Description	Image	Code	Description	Kit components	
0H2354A	XEVC-XEVL PLUS WASHING CIRCUIT PLATE		KVL1207A	US PLUS 1 ROTOR ARM WASHING SYSTEM KIT	Code	Description Qty UOM
					RC1356A0	"STRAIGHT THREADED FEMALE END 8x1/4" BS 1.000 PC
					TB2821A0	EPDM 6X10 L=40MM PIPE 6.000 PC
					TB3004A0	TB2820A L=550mm EPDM BLACK PIPE 1.000 PC
					TB3005B0	TB3132A L=550mm EPDM WHITE-BLUE PIPE 1.000 PC
					TB3225B0	TB2820A-TAN K-WASHYNG SYS CONNECTION 1.000 PC
					TB3252A0	TB3252A0 1.000 PC
					VL1019A0	VIBRATION DETERGENT PUMP 1.000 PC
					VL1047A1	D6 PIPE HOLDER - D8 J.G. TERMINAL 1.000 PC
					VL1065A1	1/4 MALE N.O. PRESSURE SWITCH 1.000 PC
					VL1102A1	DETERGENT LINE FILTER + BARBED VNR 6 MM 1.000 PC
					VL1128A1	D6 BARBED CHECK VALVE 2.000 PC
					VL1166A0	BB6-AR6 L FITTING 3.000 PC
					VL1174C0	D1.2 MM CALIBRATED D1.2 MM 1.000 PC
					VL1185A0	2 WAYS PLUS WASHING DISTRIBUTOR 1.000 PC
					VL1190A0	PLUS WASHING SYSTEM INLET DISTRIBUTOR 1.000 PC
					VL1214A0	BAYONET - 6mm BARBED NRV VALVE 1.000 PC
					VM1605A0	CLIP TWIST LOCK DIAM. 10,2-12,7 MM 3.000 PC
					VM2172A0	LOCKING CLIP FOR PUMP WITH CIRCUIT 3.000 PC



COMPONENT			SPARE PART																																																																																										
Code	Description	Image	Code	Description	Kit components																																																																																								
0H2354A	XEVC-XEVL PLUS WASHING CIRCUIT PLATE		KVL1187A	3 ROTOR ARMS PLUS EU CLEANING SYSTEM KIT	<table border="1"> <thead> <tr> <th>Code</th> <th>Description</th> <th>Qty</th> <th>UOM</th> </tr> </thead> <tbody> <tr> <td>0H2354A1</td> <td>XEVC-XEVL PLUS WASHING CIRCUIT PLAT</td> <td>1.000</td> <td>PC</td> </tr> <tr> <td>EL1440A0</td> <td>WATER SELF CLEANING VALVE</td> <td>4.000</td> <td>PC</td> </tr> <tr> <td>GN1526A0</td> <td>INT. D.=6.9 TH=1.8 O-RIN</td> <td>9.000</td> <td>PC</td> </tr> <tr> <td>RC1018A0</td> <td>ZINC PLATED D12 ELASTIC CLAMP</td> <td>11.000</td> <td>PC</td> </tr> <tr> <td>RC1019A0</td> <td>D=10 ELASTIC CLAMP</td> <td>16.000</td> <td>PC</td> </tr> <tr> <td>RC1130A0</td> <td>130x2.6 CLAM</td> <td>1.000</td> <td>PC</td> </tr> <tr> <td>RC1131A0</td> <td>200x2.6 BLACK CLAMP</td> <td>3.000</td> <td>PC</td> </tr> <tr> <td>RC1242A0</td> <td>D=10 CLOSED CAP</td> <td>2.000</td> <td>PC</td> </tr> <tr> <td>RC1356A0</td> <td>"STRAIGHT THREADED FEMALE END 8x1/4" BS</td> <td>1.000</td> <td>PC</td> </tr> <tr> <td>TB2652A0</td> <td></td> <td>1.000</td> <td>PC</td> </tr> <tr> <td>TB2677A0</td> <td></td> <td>1.000</td> <td>PC</td> </tr> <tr> <td>TB2821A0</td> <td>EPDM 6X10 L=40MM PIPE</td> <td>6.000</td> <td>PC</td> </tr> <tr> <td>TB3004A0</td> <td>TB2820A L=550mm EPDM BLACK PIPE</td> <td>2.000</td> <td>PC</td> </tr> <tr> <td>TB3024C0</td> <td></td> <td>3.000</td> <td>PC</td> </tr> <tr> <td>TB3226A0</td> <td></td> <td>1.000</td> <td>PC</td> </tr> <tr> <td>TB3440A0</td> <td>TB3132A L=1050mm EPDM WHITE-BLUE PIPE</td> <td>1.000</td> <td>PC</td> </tr> <tr> <td>VL1019A0</td> <td>VIBRATION DETERGENT PUMP</td> <td>1.000</td> <td>PC</td> </tr> <tr> <td>VL1047A1</td> <td>D6 PIPE HOLDER - D8 J.G. TERMINAL</td> <td>1.000</td> <td>PC</td> </tr> <tr> <td>VL1065A1</td> <td>1/4 MALE N.O. PRESSURE SWITCH</td> <td>1.000</td> <td>PC</td> </tr> <tr> <td>VL1102A1</td> <td>DETERGENT LINE FILTER + BARBED VNR 6 MM</td> <td>1.000</td> <td>PC</td> </tr> <tr> <td>VL1127A1</td> <td>6mm BARBED T-SHAPED FITTING</td> <td>2.000</td> <td>PC</td> </tr> </tbody> </table>	Code	Description	Qty	UOM	0H2354A1	XEVC-XEVL PLUS WASHING CIRCUIT PLAT	1.000	PC	EL1440A0	WATER SELF CLEANING VALVE	4.000	PC	GN1526A0	INT. D.=6.9 TH=1.8 O-RIN	9.000	PC	RC1018A0	ZINC PLATED D12 ELASTIC CLAMP	11.000	PC	RC1019A0	D=10 ELASTIC CLAMP	16.000	PC	RC1130A0	130x2.6 CLAM	1.000	PC	RC1131A0	200x2.6 BLACK CLAMP	3.000	PC	RC1242A0	D=10 CLOSED CAP	2.000	PC	RC1356A0	"STRAIGHT THREADED FEMALE END 8x1/4" BS	1.000	PC	TB2652A0		1.000	PC	TB2677A0		1.000	PC	TB2821A0	EPDM 6X10 L=40MM PIPE	6.000	PC	TB3004A0	TB2820A L=550mm EPDM BLACK PIPE	2.000	PC	TB3024C0		3.000	PC	TB3226A0		1.000	PC	TB3440A0	TB3132A L=1050mm EPDM WHITE-BLUE PIPE	1.000	PC	VL1019A0	VIBRATION DETERGENT PUMP	1.000	PC	VL1047A1	D6 PIPE HOLDER - D8 J.G. TERMINAL	1.000	PC	VL1065A1	1/4 MALE N.O. PRESSURE SWITCH	1.000	PC	VL1102A1	DETERGENT LINE FILTER + BARBED VNR 6 MM	1.000	PC	VL1127A1	6mm BARBED T-SHAPED FITTING	2.000	PC
Code	Description	Qty	UOM																																																																																										
0H2354A1	XEVC-XEVL PLUS WASHING CIRCUIT PLAT	1.000	PC																																																																																										
EL1440A0	WATER SELF CLEANING VALVE	4.000	PC																																																																																										
GN1526A0	INT. D.=6.9 TH=1.8 O-RIN	9.000	PC																																																																																										
RC1018A0	ZINC PLATED D12 ELASTIC CLAMP	11.000	PC																																																																																										
RC1019A0	D=10 ELASTIC CLAMP	16.000	PC																																																																																										
RC1130A0	130x2.6 CLAM	1.000	PC																																																																																										
RC1131A0	200x2.6 BLACK CLAMP	3.000	PC																																																																																										
RC1242A0	D=10 CLOSED CAP	2.000	PC																																																																																										
RC1356A0	"STRAIGHT THREADED FEMALE END 8x1/4" BS	1.000	PC																																																																																										
TB2652A0		1.000	PC																																																																																										
TB2677A0		1.000	PC																																																																																										
TB2821A0	EPDM 6X10 L=40MM PIPE	6.000	PC																																																																																										
TB3004A0	TB2820A L=550mm EPDM BLACK PIPE	2.000	PC																																																																																										
TB3024C0		3.000	PC																																																																																										
TB3226A0		1.000	PC																																																																																										
TB3440A0	TB3132A L=1050mm EPDM WHITE-BLUE PIPE	1.000	PC																																																																																										
VL1019A0	VIBRATION DETERGENT PUMP	1.000	PC																																																																																										
VL1047A1	D6 PIPE HOLDER - D8 J.G. TERMINAL	1.000	PC																																																																																										
VL1065A1	1/4 MALE N.O. PRESSURE SWITCH	1.000	PC																																																																																										
VL1102A1	DETERGENT LINE FILTER + BARBED VNR 6 MM	1.000	PC																																																																																										
VL1127A1	6mm BARBED T-SHAPED FITTING	2.000	PC																																																																																										



COMPONENT			SPARE PART																																											
Code	Description	Image	Code	Description	Kit components																																									
0H2354A	XEVC-XEVL PLUS WASHING CIRCUIT PLATE		KVL1187A	3 ROTOR ARMS PLUS EU CLEANING SYSTEM KIT	<table border="1"> <thead> <tr> <th>Code</th> <th>Description</th> <th>Qty</th> <th>UOM</th> </tr> </thead> <tbody> <tr> <td>VL1128A1</td> <td>D6 BARBED CHECK VALVE</td> <td>3.000</td> <td>PC</td> </tr> <tr> <td>VL1166A0</td> <td>BB6-AR6 L FITTING</td> <td>4.000</td> <td>PC</td> </tr> <tr> <td>VL1167A2</td> <td>GN21 3 ROTOR ARMS B-B FLOW RESTRICTOR</td> <td>1.000</td> <td>PC</td> </tr> <tr> <td>VL1174C0</td> <td>D1.2 MM CALIBRATED D1.2 MM</td> <td>1.000</td> <td>PC</td> </tr> <tr> <td>VL1186A0</td> <td>3 WAYS PLUS WASHING DISTRIBUTOR</td> <td>1.000</td> <td>PC</td> </tr> <tr> <td>VL1190A0</td> <td>PLUS WASHING SYSTEM INLET DISTRIBUTOR</td> <td>1.000</td> <td>PC</td> </tr> <tr> <td>VL1214A0</td> <td>BAYONET - 6mm BARBED NRV VALVE</td> <td>1.000</td> <td>PC</td> </tr> <tr> <td>VM1605A0</td> <td>CLIP TWIST LOCK DIAM. 10,2-12,7 MM</td> <td>3.000</td> <td>PC</td> </tr> <tr> <td>VM2172A0</td> <td>LOCKING CLIP FOR PUMP WITH CIRCUIT</td> <td>5.000</td> <td>PC</td> </tr> </tbody> </table>	Code	Description	Qty	UOM	VL1128A1	D6 BARBED CHECK VALVE	3.000	PC	VL1166A0	BB6-AR6 L FITTING	4.000	PC	VL1167A2	GN21 3 ROTOR ARMS B-B FLOW RESTRICTOR	1.000	PC	VL1174C0	D1.2 MM CALIBRATED D1.2 MM	1.000	PC	VL1186A0	3 WAYS PLUS WASHING DISTRIBUTOR	1.000	PC	VL1190A0	PLUS WASHING SYSTEM INLET DISTRIBUTOR	1.000	PC	VL1214A0	BAYONET - 6mm BARBED NRV VALVE	1.000	PC	VM1605A0	CLIP TWIST LOCK DIAM. 10,2-12,7 MM	3.000	PC	VM2172A0	LOCKING CLIP FOR PUMP WITH CIRCUIT	5.000	PC	
			Code	Description	Qty	UOM																																								
VL1128A1	D6 BARBED CHECK VALVE	3.000	PC																																											
VL1166A0	BB6-AR6 L FITTING	4.000	PC																																											
VL1167A2	GN21 3 ROTOR ARMS B-B FLOW RESTRICTOR	1.000	PC																																											
VL1174C0	D1.2 MM CALIBRATED D1.2 MM	1.000	PC																																											
VL1186A0	3 WAYS PLUS WASHING DISTRIBUTOR	1.000	PC																																											
VL1190A0	PLUS WASHING SYSTEM INLET DISTRIBUTOR	1.000	PC																																											
VL1214A0	BAYONET - 6mm BARBED NRV VALVE	1.000	PC																																											
VM1605A0	CLIP TWIST LOCK DIAM. 10,2-12,7 MM	3.000	PC																																											
VM2172A0	LOCKING CLIP FOR PUMP WITH CIRCUIT	5.000	PC																																											
KVL1184A	2 ROTOR ARMS PLUS EU CLEANING SYSTEM KIT	<table border="1"> <thead> <tr> <th>Code</th> <th>Description</th> <th>Qty</th> <th>UOM</th> </tr> </thead> <tbody> <tr> <td>0H2354A1</td> <td>XEVC-XEVL PLUS WASHING CIRCUIT PLAT</td> <td>1.000</td> <td>PC</td> </tr> <tr> <td>EL1440A0</td> <td>WATER SELF CLEANING VALVE</td> <td>4.000</td> <td>PC</td> </tr> <tr> <td>GN1526A0</td> <td>INT. D.=6.9 TH=1.8 O-RIN</td> <td>9.000</td> <td>PC</td> </tr> <tr> <td>RC1018A0</td> <td>ZINC PLATED D12 ELASTIC CLAMP</td> <td>3.000</td> <td>PC</td> </tr> <tr> <td>RC1019A0</td> <td>D=10 ELASTIC CLAMP</td> <td>15.000</td> <td>PC</td> </tr> <tr> <td>RC1130A0</td> <td>130x2.6 CLAM</td> <td>1.000</td> <td>PC</td> </tr> <tr> <td>RC1131A0</td> <td>200x2.6 BLACK CLAMP</td> <td>3.000</td> <td>PC</td> </tr> <tr> <td>RC1242A0</td> <td>D=10 CLOSED CAP</td> <td>2.000</td> <td>PC</td> </tr> <tr> <td>RC1356A0</td> <td>"STRAIGHT THREADED FEMALE END 8x1/4" BS</td> <td>1.000</td> <td>PC</td> </tr> <tr> <td>TB2821A0</td> <td>EPDM 6X10 L=40MM PIPE</td> <td>6.000</td> <td>PC</td> </tr> </tbody> </table>	Code	Description	Qty	UOM	0H2354A1	XEVC-XEVL PLUS WASHING CIRCUIT PLAT	1.000	PC	EL1440A0	WATER SELF CLEANING VALVE	4.000	PC	GN1526A0	INT. D.=6.9 TH=1.8 O-RIN	9.000	PC	RC1018A0	ZINC PLATED D12 ELASTIC CLAMP	3.000	PC	RC1019A0	D=10 ELASTIC CLAMP	15.000	PC	RC1130A0	130x2.6 CLAM	1.000	PC	RC1131A0	200x2.6 BLACK CLAMP	3.000	PC	RC1242A0	D=10 CLOSED CAP	2.000	PC	RC1356A0	"STRAIGHT THREADED FEMALE END 8x1/4" BS	1.000	PC	TB2821A0	EPDM 6X10 L=40MM PIPE	6.000	PC
Code	Description	Qty	UOM																																											
0H2354A1	XEVC-XEVL PLUS WASHING CIRCUIT PLAT	1.000	PC																																											
EL1440A0	WATER SELF CLEANING VALVE	4.000	PC																																											
GN1526A0	INT. D.=6.9 TH=1.8 O-RIN	9.000	PC																																											
RC1018A0	ZINC PLATED D12 ELASTIC CLAMP	3.000	PC																																											
RC1019A0	D=10 ELASTIC CLAMP	15.000	PC																																											
RC1130A0	130x2.6 CLAM	1.000	PC																																											
RC1131A0	200x2.6 BLACK CLAMP	3.000	PC																																											
RC1242A0	D=10 CLOSED CAP	2.000	PC																																											
RC1356A0	"STRAIGHT THREADED FEMALE END 8x1/4" BS	1.000	PC																																											
TB2821A0	EPDM 6X10 L=40MM PIPE	6.000	PC																																											





COMPONENT			SPARE PART																																																																										
Code	Description	Image	Code	Description	Kit components																																																																								
0H2354A	XEVC-XEVL PLUS WASHING CIRCUIT PLATE		KVL1184A	2 ROTOR ARMS PLUS EU CLEANING SYSTEM KIT	<table border="1"> <thead> <tr> <th>Code</th> <th>Description</th> <th>Qty</th> <th>UOM</th> </tr> </thead> <tbody> <tr> <td>TB2994A0</td> <td>HOOD DETERGENT PIPE</td> <td>1.000</td> <td>PC</td> </tr> <tr> <td>TB3004A0</td> <td>TB2820A L=550mm EPDM BLACK PIPE</td> <td>2.000</td> <td>PC</td> </tr> <tr> <td>TB3005B0</td> <td>TB3132A L=550mm EPDM WHITE-BLUE PIPE</td> <td>1.000</td> <td>PC</td> </tr> <tr> <td>TB3440A0</td> <td>TB3132A L=1050mm EPDM WHITE-BLUE PIPE</td> <td>1.000</td> <td>PC</td> </tr> <tr> <td>VL1019A0</td> <td>VIBRATION DETERGENT PUMP</td> <td>1.000</td> <td>PC</td> </tr> <tr> <td>VL1047A1</td> <td>D6 PIPE HOLDER - D8 J.G. TERMINAL</td> <td>1.000</td> <td>PC</td> </tr> <tr> <td>VL1065A1</td> <td>1/4 MALE N.O. PRESSURE SWITCH</td> <td>1.000</td> <td>PC</td> </tr> <tr> <td>VL1102A1</td> <td>DETERGENT LINE FILTER + BARBED VNR 6 MM</td> <td>1.000</td> <td>PC</td> </tr> <tr> <td>VL1128A1</td> <td>D6 BARBED CHECK VALVE</td> <td>2.000</td> <td>PC</td> </tr> <tr> <td>VL1141A1</td> <td>BB6-BB6 STRAIGHT CONNECTION</td> <td>1.000</td> <td>PC</td> </tr> <tr> <td>VL1166A0</td> <td>BB6-AR6 L FITTING</td> <td>4.000</td> <td>PC</td> </tr> <tr> <td>VL1174C0</td> <td>D1.2 MM CALIBRATED D1.2 MM</td> <td>1.000</td> <td>PC</td> </tr> <tr> <td>VL1186A0</td> <td>3 WAYS PLUS WASHING DISTRIBUTOR</td> <td>1.000</td> <td>PC</td> </tr> <tr> <td>VL1190A0</td> <td>PLUS WASHING SYSTEM INLET DISTRIBUTOR</td> <td>1.000</td> <td>PC</td> </tr> <tr> <td>VL1214A0</td> <td>BAYONET - 6mm BARBED NRV VALVE</td> <td>1.000</td> <td>PC</td> </tr> <tr> <td>VM1605A0</td> <td>CLIP TWIST LOCK DIAM. 10,2-12,7 MM</td> <td>3.000</td> <td>PC</td> </tr> <tr> <td>VM2172A0</td> <td>LOCKING CLIP FOR PUMP WITH CIRCUIT</td> <td>5.000</td> <td>PC</td> </tr> </tbody> </table>	Code	Description	Qty	UOM	TB2994A0	HOOD DETERGENT PIPE	1.000	PC	TB3004A0	TB2820A L=550mm EPDM BLACK PIPE	2.000	PC	TB3005B0	TB3132A L=550mm EPDM WHITE-BLUE PIPE	1.000	PC	TB3440A0	TB3132A L=1050mm EPDM WHITE-BLUE PIPE	1.000	PC	VL1019A0	VIBRATION DETERGENT PUMP	1.000	PC	VL1047A1	D6 PIPE HOLDER - D8 J.G. TERMINAL	1.000	PC	VL1065A1	1/4 MALE N.O. PRESSURE SWITCH	1.000	PC	VL1102A1	DETERGENT LINE FILTER + BARBED VNR 6 MM	1.000	PC	VL1128A1	D6 BARBED CHECK VALVE	2.000	PC	VL1141A1	BB6-BB6 STRAIGHT CONNECTION	1.000	PC	VL1166A0	BB6-AR6 L FITTING	4.000	PC	VL1174C0	D1.2 MM CALIBRATED D1.2 MM	1.000	PC	VL1186A0	3 WAYS PLUS WASHING DISTRIBUTOR	1.000	PC	VL1190A0	PLUS WASHING SYSTEM INLET DISTRIBUTOR	1.000	PC	VL1214A0	BAYONET - 6mm BARBED NRV VALVE	1.000	PC	VM1605A0	CLIP TWIST LOCK DIAM. 10,2-12,7 MM	3.000	PC	VM2172A0	LOCKING CLIP FOR PUMP WITH CIRCUIT	5.000	PC
					Code	Description	Qty	UOM																																																																					
					TB2994A0	HOOD DETERGENT PIPE	1.000	PC																																																																					
					TB3004A0	TB2820A L=550mm EPDM BLACK PIPE	2.000	PC																																																																					
					TB3005B0	TB3132A L=550mm EPDM WHITE-BLUE PIPE	1.000	PC																																																																					
					TB3440A0	TB3132A L=1050mm EPDM WHITE-BLUE PIPE	1.000	PC																																																																					
					VL1019A0	VIBRATION DETERGENT PUMP	1.000	PC																																																																					
					VL1047A1	D6 PIPE HOLDER - D8 J.G. TERMINAL	1.000	PC																																																																					
					VL1065A1	1/4 MALE N.O. PRESSURE SWITCH	1.000	PC																																																																					
					VL1102A1	DETERGENT LINE FILTER + BARBED VNR 6 MM	1.000	PC																																																																					
					VL1128A1	D6 BARBED CHECK VALVE	2.000	PC																																																																					
					VL1141A1	BB6-BB6 STRAIGHT CONNECTION	1.000	PC																																																																					
					VL1166A0	BB6-AR6 L FITTING	4.000	PC																																																																					
					VL1174C0	D1.2 MM CALIBRATED D1.2 MM	1.000	PC																																																																					
					VL1186A0	3 WAYS PLUS WASHING DISTRIBUTOR	1.000	PC																																																																					
					VL1190A0	PLUS WASHING SYSTEM INLET DISTRIBUTOR	1.000	PC																																																																					
					VL1214A0	BAYONET - 6mm BARBED NRV VALVE	1.000	PC																																																																					
					VM1605A0	CLIP TWIST LOCK DIAM. 10,2-12,7 MM	3.000	PC																																																																					
					VM2172A0	LOCKING CLIP FOR PUMP WITH CIRCUIT	5.000	PC																																																																					



COMPONENT			SPARE PART																																																																																		
Code	Description	Image	Code	Description	Kit components																																																																																
0H2354A	XEVC-XEVL PLUS WASHING CIRCUIT PLATE		KVL1183A	1 ROTOR ARM PLUS CLEANING SYSTEM KIT	<table border="1"> <thead> <tr> <th>Code</th> <th>Description</th> <th>Qty</th> <th>UOM</th> </tr> </thead> <tbody> <tr> <td>0H2354A1</td> <td>XEVC-XEVL PLUS WASHING CIRCUIT PLAT</td> <td>1.000</td> <td>PC</td> </tr> <tr> <td>EL1440A0</td> <td>WATER SELF CLEANING VALVE</td> <td>3.000</td> <td>PC</td> </tr> <tr> <td>GN1526A0</td> <td>INT. D.=6.9 TH=1.8 O-RIN</td> <td>7.000</td> <td>PC</td> </tr> <tr> <td>RC1018A0</td> <td>ZINC PLATED D12 ELASTIC CLAMP</td> <td>2.000</td> <td>PC</td> </tr> <tr> <td>RC1019A0</td> <td>D=10 ELASTIC CLAMP</td> <td>14.000</td> <td>PC</td> </tr> <tr> <td>RC1130A0</td> <td>130x2.6 CLAM</td> <td>1.000</td> <td>PC</td> </tr> <tr> <td>RC1131A0</td> <td>200x2.6 BLACK CLAMP</td> <td>2.000</td> <td>PC</td> </tr> <tr> <td>RC1242A0</td> <td>D=10 CLOSED CAP</td> <td>2.000</td> <td>PC</td> </tr> <tr> <td>RC1356A0</td> <td>"STRAIGHT THREADED FEMALE END 8x1/4" BS</td> <td>1.000</td> <td>PC</td> </tr> <tr> <td>TB2821A0</td> <td>EPDM 6X10 L=40MM PIPE</td> <td>6.000</td> <td>PC</td> </tr> <tr> <td>TB3004A0</td> <td>TB2820A L=550mm EPDM BLACK PIPE</td> <td>1.000</td> <td>PC</td> </tr> <tr> <td>TB3005B0</td> <td>TB3132A L=550mm EPDM WHITE-BLUE PIPE</td> <td>1.000</td> <td>PC</td> </tr> <tr> <td>TB3225B0</td> <td>TB2820A-TAN K-WASHYNG SYS CONNECTION</td> <td>1.000</td> <td>PC</td> </tr> <tr> <td>TB3252A0</td> <td>TB3252A0</td> <td>1.000</td> <td>PC</td> </tr> <tr> <td>VL1019A0</td> <td>VIBRATION DETERGENT PUMP</td> <td>1.000</td> <td>PC</td> </tr> <tr> <td>VL1047A1</td> <td>D6 PIPE HOLDER - D8 J.G. TERMINAL</td> <td>1.000</td> <td>PC</td> </tr> <tr> <td>VL1065A1</td> <td>1/4 MALE N.O. PRESSURE SWITCH</td> <td>1.000</td> <td>PC</td> </tr> <tr> <td>VL1102A1</td> <td>DETERGENT LINE FILTER + BARBED VNR 6 MM</td> <td>1.000</td> <td>PC</td> </tr> <tr> <td>VL1128A1</td> <td>D6 BARBED CHECK VALVE</td> <td>2.000</td> <td>PC</td> </tr> </tbody> </table>	Code	Description	Qty	UOM	0H2354A1	XEVC-XEVL PLUS WASHING CIRCUIT PLAT	1.000	PC	EL1440A0	WATER SELF CLEANING VALVE	3.000	PC	GN1526A0	INT. D.=6.9 TH=1.8 O-RIN	7.000	PC	RC1018A0	ZINC PLATED D12 ELASTIC CLAMP	2.000	PC	RC1019A0	D=10 ELASTIC CLAMP	14.000	PC	RC1130A0	130x2.6 CLAM	1.000	PC	RC1131A0	200x2.6 BLACK CLAMP	2.000	PC	RC1242A0	D=10 CLOSED CAP	2.000	PC	RC1356A0	"STRAIGHT THREADED FEMALE END 8x1/4" BS	1.000	PC	TB2821A0	EPDM 6X10 L=40MM PIPE	6.000	PC	TB3004A0	TB2820A L=550mm EPDM BLACK PIPE	1.000	PC	TB3005B0	TB3132A L=550mm EPDM WHITE-BLUE PIPE	1.000	PC	TB3225B0	TB2820A-TAN K-WASHYNG SYS CONNECTION	1.000	PC	TB3252A0	TB3252A0	1.000	PC	VL1019A0	VIBRATION DETERGENT PUMP	1.000	PC	VL1047A1	D6 PIPE HOLDER - D8 J.G. TERMINAL	1.000	PC	VL1065A1	1/4 MALE N.O. PRESSURE SWITCH	1.000	PC	VL1102A1	DETERGENT LINE FILTER + BARBED VNR 6 MM	1.000	PC	VL1128A1	D6 BARBED CHECK VALVE	2.000	PC
					Code	Description	Qty	UOM																																																																													
					0H2354A1	XEVC-XEVL PLUS WASHING CIRCUIT PLAT	1.000	PC																																																																													
					EL1440A0	WATER SELF CLEANING VALVE	3.000	PC																																																																													
					GN1526A0	INT. D.=6.9 TH=1.8 O-RIN	7.000	PC																																																																													
					RC1018A0	ZINC PLATED D12 ELASTIC CLAMP	2.000	PC																																																																													
					RC1019A0	D=10 ELASTIC CLAMP	14.000	PC																																																																													
					RC1130A0	130x2.6 CLAM	1.000	PC																																																																													
					RC1131A0	200x2.6 BLACK CLAMP	2.000	PC																																																																													
					RC1242A0	D=10 CLOSED CAP	2.000	PC																																																																													
					RC1356A0	"STRAIGHT THREADED FEMALE END 8x1/4" BS	1.000	PC																																																																													
					TB2821A0	EPDM 6X10 L=40MM PIPE	6.000	PC																																																																													
					TB3004A0	TB2820A L=550mm EPDM BLACK PIPE	1.000	PC																																																																													
					TB3005B0	TB3132A L=550mm EPDM WHITE-BLUE PIPE	1.000	PC																																																																													
					TB3225B0	TB2820A-TAN K-WASHYNG SYS CONNECTION	1.000	PC																																																																													
TB3252A0	TB3252A0	1.000	PC																																																																																		
VL1019A0	VIBRATION DETERGENT PUMP	1.000	PC																																																																																		
VL1047A1	D6 PIPE HOLDER - D8 J.G. TERMINAL	1.000	PC																																																																																		
VL1065A1	1/4 MALE N.O. PRESSURE SWITCH	1.000	PC																																																																																		
VL1102A1	DETERGENT LINE FILTER + BARBED VNR 6 MM	1.000	PC																																																																																		
VL1128A1	D6 BARBED CHECK VALVE	2.000	PC																																																																																		



COMPONENT			SPARE PART																																		
Code	Description	Image	Code	Description	Kit components																																
0H2354A	XEVC-XEVL PLUS WASHING CIRCUIT PLATE		KVL1183A	1 ROTOR ARM PLUS CLEANING SYSTEM KIT	<table border="1"> <thead> <tr> <th>Code</th> <th>Description</th> <th>Qty</th> <th>UOM</th> </tr> </thead> <tbody> <tr> <td>VL1166A0</td> <td>BB6-AR6 L FITTING</td> <td>3.000</td> <td>PC</td> </tr> <tr> <td>VL1174C0</td> <td>D1.2 MM CALIBRATED D1.2 MM</td> <td>1.000</td> <td>PC</td> </tr> <tr> <td>VL1185A0</td> <td>2 WAYS PLUS WASHING DISTRIBUTOR</td> <td>1.000</td> <td>PC</td> </tr> <tr> <td>VL1190A0</td> <td>PLUS WASHING SYSTEM INLET DISTRIBUTOR</td> <td>1.000</td> <td>PC</td> </tr> <tr> <td>VL1214A0</td> <td>BAYONET - 6mm BARBED NRV VALVE</td> <td>1.000</td> <td>PC</td> </tr> <tr> <td>VM1605A0</td> <td>CLIP TWIST LOCK DIAM. 10,2-12,7 MM</td> <td>3.000</td> <td>PC</td> </tr> <tr> <td>VM2172A0</td> <td>LOCKING CLIP FOR PUMP WITH CIRCUIT</td> <td>4.000</td> <td>PC</td> </tr> </tbody> </table>	Code	Description	Qty	UOM	VL1166A0	BB6-AR6 L FITTING	3.000	PC	VL1174C0	D1.2 MM CALIBRATED D1.2 MM	1.000	PC	VL1185A0	2 WAYS PLUS WASHING DISTRIBUTOR	1.000	PC	VL1190A0	PLUS WASHING SYSTEM INLET DISTRIBUTOR	1.000	PC	VL1214A0	BAYONET - 6mm BARBED NRV VALVE	1.000	PC	VM1605A0	CLIP TWIST LOCK DIAM. 10,2-12,7 MM	3.000	PC	VM2172A0	LOCKING CLIP FOR PUMP WITH CIRCUIT	4.000	PC
					Code	Description	Qty	UOM																													
					VL1166A0	BB6-AR6 L FITTING	3.000	PC																													
					VL1174C0	D1.2 MM CALIBRATED D1.2 MM	1.000	PC																													
					VL1185A0	2 WAYS PLUS WASHING DISTRIBUTOR	1.000	PC																													
					VL1190A0	PLUS WASHING SYSTEM INLET DISTRIBUTOR	1.000	PC																													
					VL1214A0	BAYONET - 6mm BARBED NRV VALVE	1.000	PC																													
					VM1605A0	CLIP TWIST LOCK DIAM. 10,2-12,7 MM	3.000	PC																													
VM2172A0	LOCKING CLIP FOR PUMP WITH CIRCUIT	4.000	PC																																		
GN1526A	INT. D.=6.9 TH=1.8 O-RING		KGN1526A	O-RING INT D6.9 THICK1.8 10PCS KIT	<table border="1"> <thead> <tr> <th>Code</th> <th>Description</th> <th>Qty</th> <th>UOM</th> </tr> </thead> <tbody> <tr> <td>GN1526A0</td> <td>INT. D.=6.9 TH=1.8 O-RIN</td> <td>10.000</td> <td>PC</td> </tr> </tbody> </table>	Code	Description	Qty	UOM	GN1526A0	INT. D.=6.9 TH=1.8 O-RIN	10.000	PC																								
Code	Description	Qty	UOM																																		
GN1526A0	INT. D.=6.9 TH=1.8 O-RIN	10.000	PC																																		
RC1019A	D=10 ELASTIC CLAM		KRC1019A	Ø10 ZINC PLATED ELASTIC CLAMP 15 PCS KIT	<table border="1"> <thead> <tr> <th>Code</th> <th>Description</th> <th>Qty</th> <th>UOM</th> </tr> </thead> <tbody> <tr> <td>RC1019A0</td> <td>D=10 ELASTIC CLAMP</td> <td>15.000</td> <td>PC</td> </tr> </tbody> </table>	Code	Description	Qty	UOM	RC1019A0	D=10 ELASTIC CLAMP	15.000	PC																								
Code	Description	Qty	UOM																																		
RC1019A0	D=10 ELASTIC CLAMP	15.000	PC																																		
RC1242A	D=10 CLOSED CAP		KRC1242A	Ø10 CLOSED CONNECTION 20PCS KIT	<table border="1"> <thead> <tr> <th>Code</th> <th>Description</th> <th>Qty</th> <th>UOM</th> </tr> </thead> <tbody> <tr> <td>RC1242A0</td> <td>D=10 CLOSED CAP</td> <td>20.000</td> <td>PC</td> </tr> </tbody> </table>	Code	Description	Qty	UOM	RC1242A0	D=10 CLOSED CAP	20.000	PC																								
Code	Description	Qty	UOM																																		
RC1242A0	D=10 CLOSED CAP	20.000	PC																																		





COMPONENT			SPARE PART																																																																						
Code	Description	Image	Code	Description	Kit components																																																																				
RC1356A	"STRAIGHT THREADED FEMALE END 8x1/4" BS		KRC1356A	STRAIGHT THREADED FEMALE END 8X1/4 BS	<table border="1"> <thead> <tr> <th>Code</th> <th>Description</th> <th>Qty</th> <th>UOM</th> </tr> </thead> <tbody> <tr> <td>RC1356A0</td> <td>"STRAIGHT THREADED FEMALE END 8x1/4" BS</td> <td>1.000</td> <td>PC</td> </tr> </tbody> </table>	Code	Description	Qty	UOM	RC1356A0	"STRAIGHT THREADED FEMALE END 8x1/4" BS	1.000	PC																																																												
Code	Description	Qty	UOM																																																																						
RC1356A0	"STRAIGHT THREADED FEMALE END 8x1/4" BS	1.000	PC																																																																						
VL1019A	VIBRATION DETERGENT PUMP		KVL2618A	2 ROTOR ARMS ONE CLEANING SYSTEM KIT	<table border="1"> <thead> <tr> <th>Code</th> <th>Description</th> <th>Qty</th> <th>UOM</th> </tr> </thead> <tbody> <tr> <td>0H2202A1</td> <td>ONE WASHING WITH STEAM VALVE SUPPORT</td> <td>2.000</td> <td>PC</td> </tr> <tr> <td>CE1030A0</td> <td>FEMALE FASTON COVER 6.3X0.8 0,5-1mmq</td> <td>4.000</td> <td>PC</td> </tr> <tr> <td>CE1395A0</td> <td>6,3 X 0,8 MALE FASTO</td> <td>2.000</td> <td>PC</td> </tr> <tr> <td>CE1545A0</td> <td>BLUE UNIP AWG18 ST.3135 WIRE</td> <td>2.000</td> <td>M</td> </tr> <tr> <td>CE1570A0</td> <td>WHITE UNIP AWG18 ST.3135 WIRE</td> <td>2.000</td> <td>M</td> </tr> <tr> <td>CE1660A0</td> <td>6,3x0,8 FEMALE FASTON COVE</td> <td>4.000</td> <td>PC</td> </tr> <tr> <td>CE1661A0</td> <td>MALE FASTON COVER 6,3x0,8</td> <td>2.000</td> <td>PC</td> </tr> <tr> <td>EL1020A1</td> <td>D8 INTERMEDIAT E T-SHAPED FITTING</td> <td>1.000</td> <td>PC</td> </tr> <tr> <td>EL1440A0</td> <td>WATER SELF CLEANING VALVE</td> <td>2.000</td> <td>PC</td> </tr> <tr> <td>GN1526A0</td> <td>INT. D.=6.9 TH=1.8 O-RIN</td> <td>6.000</td> <td>PC</td> </tr> <tr> <td>RC1018A0</td> <td>ZINC PLATED D12 ELASTIC CLAMP</td> <td>2.000</td> <td>PC</td> </tr> <tr> <td>RC1019A0</td> <td>D=10 ELASTIC CLAMP</td> <td>28.000</td> <td>PC</td> </tr> <tr> <td>RC1130A0</td> <td>130x2,6 CLAM</td> <td>4.000</td> <td>PC</td> </tr> <tr> <td>RC1242A0</td> <td>D=10 CLOSED CAP</td> <td>4.000</td> <td>PC</td> </tr> <tr> <td>TB2821A0</td> <td>EPDM 6X10 L=40MM PIPE</td> <td>12.000</td> <td>PC</td> </tr> <tr> <td>TB3004A0</td> <td>TB2820A L=550mm EPDM BLACK PIPE</td> <td>2.000</td> <td>PC</td> </tr> </tbody> </table>	Code	Description	Qty	UOM	0H2202A1	ONE WASHING WITH STEAM VALVE SUPPORT	2.000	PC	CE1030A0	FEMALE FASTON COVER 6.3X0.8 0,5-1mmq	4.000	PC	CE1395A0	6,3 X 0,8 MALE FASTO	2.000	PC	CE1545A0	BLUE UNIP AWG18 ST.3135 WIRE	2.000	M	CE1570A0	WHITE UNIP AWG18 ST.3135 WIRE	2.000	M	CE1660A0	6,3x0,8 FEMALE FASTON COVE	4.000	PC	CE1661A0	MALE FASTON COVER 6,3x0,8	2.000	PC	EL1020A1	D8 INTERMEDIAT E T-SHAPED FITTING	1.000	PC	EL1440A0	WATER SELF CLEANING VALVE	2.000	PC	GN1526A0	INT. D.=6.9 TH=1.8 O-RIN	6.000	PC	RC1018A0	ZINC PLATED D12 ELASTIC CLAMP	2.000	PC	RC1019A0	D=10 ELASTIC CLAMP	28.000	PC	RC1130A0	130x2,6 CLAM	4.000	PC	RC1242A0	D=10 CLOSED CAP	4.000	PC	TB2821A0	EPDM 6X10 L=40MM PIPE	12.000	PC	TB3004A0	TB2820A L=550mm EPDM BLACK PIPE	2.000	PC
Code	Description	Qty	UOM																																																																						
0H2202A1	ONE WASHING WITH STEAM VALVE SUPPORT	2.000	PC																																																																						
CE1030A0	FEMALE FASTON COVER 6.3X0.8 0,5-1mmq	4.000	PC																																																																						
CE1395A0	6,3 X 0,8 MALE FASTO	2.000	PC																																																																						
CE1545A0	BLUE UNIP AWG18 ST.3135 WIRE	2.000	M																																																																						
CE1570A0	WHITE UNIP AWG18 ST.3135 WIRE	2.000	M																																																																						
CE1660A0	6,3x0,8 FEMALE FASTON COVE	4.000	PC																																																																						
CE1661A0	MALE FASTON COVER 6,3x0,8	2.000	PC																																																																						
EL1020A1	D8 INTERMEDIAT E T-SHAPED FITTING	1.000	PC																																																																						
EL1440A0	WATER SELF CLEANING VALVE	2.000	PC																																																																						
GN1526A0	INT. D.=6.9 TH=1.8 O-RIN	6.000	PC																																																																						
RC1018A0	ZINC PLATED D12 ELASTIC CLAMP	2.000	PC																																																																						
RC1019A0	D=10 ELASTIC CLAMP	28.000	PC																																																																						
RC1130A0	130x2,6 CLAM	4.000	PC																																																																						
RC1242A0	D=10 CLOSED CAP	4.000	PC																																																																						
TB2821A0	EPDM 6X10 L=40MM PIPE	12.000	PC																																																																						
TB3004A0	TB2820A L=550mm EPDM BLACK PIPE	2.000	PC																																																																						



COMPONENT			SPARE PART																																																																																	
Code	Description	Image	Code	Description	Kit components																																																																															
VL1019A	VIBRATION DETERGENT PUMP		KVL2618A	2 ROTOR ARMS ONE CLEANING SYSTEM KIT	<table border="1"> <thead> <tr> <th>Code</th> <th>Description</th> <th>Qty</th> <th>UOM</th> </tr> </thead> <tbody> <tr> <td>TB3009B0</td> <td>TB3132A-ONE OVEN WASHING INLET</td> <td>2.000</td> <td>PC</td> </tr> <tr> <td>TB3225B0</td> <td>TB2820A-TAN K-WASHYNG SYS CONNECTION</td> <td>2.000</td> <td>PC</td> </tr> <tr> <td>VI1220A1</td> <td>4,2x12 TCB SELF-TAPPIN G SCREW</td> <td>2.000</td> <td>PC</td> </tr> <tr> <td>VL1019A0</td> <td>VIBRATION DETERGENT PUMP</td> <td>2.000</td> <td>PC</td> </tr> <tr> <td>VL1047A1</td> <td>D6 PIPE HOLDER - D8 J.G. TERMINAL</td> <td>2.000</td> <td>PC</td> </tr> <tr> <td>VL1054B0</td> <td>ONE WASHING SYS INLET DISTRIBUTOR</td> <td>2.000</td> <td>PC</td> </tr> <tr> <td>VL1102A1</td> <td>DETERGENT LINE FILTER + BARBED VNR 6 MM</td> <td>2.000</td> <td>PC</td> </tr> <tr> <td>VL1127A1</td> <td>6mm BARBED T-SHAPED FITTING</td> <td>1.000</td> <td>PC</td> </tr> <tr> <td>VL1128A1</td> <td>D6 BARBED CHECK VALVE</td> <td>4.000</td> <td>PC</td> </tr> <tr> <td>VL1166A0</td> <td>BB6-AR6 L FITTING</td> <td>2.000</td> <td>PC</td> </tr> <tr> <td>VL1174C0</td> <td>D1.2 MM CALIBRATED D1.2 MM</td> <td>2.000</td> <td>PC</td> </tr> <tr> <td>VL1191A0</td> <td>ONE WASHING DISTRIBUTOR OUTLETS KIT</td> <td>2.000</td> <td>PC</td> </tr> <tr> <td>VL1214A0</td> <td>BAYONET - 6mm BARBED NRV VALVE</td> <td>2.000</td> <td>PC</td> </tr> <tr> <td>VM2172A0</td> <td>LOCKING CLIP FOR PUMP WITH CIRCUIT</td> <td>4.000</td> <td>PC</td> </tr> </tbody> </table>	Code	Description	Qty	UOM	TB3009B0	TB3132A-ONE OVEN WASHING INLET	2.000	PC	TB3225B0	TB2820A-TAN K-WASHYNG SYS CONNECTION	2.000	PC	VI1220A1	4,2x12 TCB SELF-TAPPIN G SCREW	2.000	PC	VL1019A0	VIBRATION DETERGENT PUMP	2.000	PC	VL1047A1	D6 PIPE HOLDER - D8 J.G. TERMINAL	2.000	PC	VL1054B0	ONE WASHING SYS INLET DISTRIBUTOR	2.000	PC	VL1102A1	DETERGENT LINE FILTER + BARBED VNR 6 MM	2.000	PC	VL1127A1	6mm BARBED T-SHAPED FITTING	1.000	PC	VL1128A1	D6 BARBED CHECK VALVE	4.000	PC	VL1166A0	BB6-AR6 L FITTING	2.000	PC	VL1174C0	D1.2 MM CALIBRATED D1.2 MM	2.000	PC	VL1191A0	ONE WASHING DISTRIBUTOR OUTLETS KIT	2.000	PC	VL1214A0	BAYONET - 6mm BARBED NRV VALVE	2.000	PC	VM2172A0	LOCKING CLIP FOR PUMP WITH CIRCUIT	4.000	PC	KVL1225A	US HOOD WASHING SYSTEM KIT	<table border="1"> <thead> <tr> <th>Code</th> <th>Description</th> <th>Qty</th> <th>UOM</th> </tr> </thead> <tbody> <tr> <td>0H2213A1</td> <td>HOOD WATER CIRCUIT PLAT</td> <td>1.000</td> <td>PC</td> </tr> <tr> <td>EL1450A0</td> <td>US SELF-CLEANIN G WATER SOLENOID</td> <td>2.000</td> <td>PC</td> </tr> <tr> <td>GN1526A0</td> <td>INT. D.=6.9 TH=1.8 O-RIN</td> <td>5.000</td> <td>PC</td> </tr> </tbody> </table>	Code	Description	Qty	UOM	0H2213A1	HOOD WATER CIRCUIT PLAT	1.000	PC	EL1450A0	US SELF-CLEANIN G WATER SOLENOID	2.000	PC	GN1526A0	INT. D.=6.9 TH=1.8 O-RIN	5.000	PC
			Code	Description	Qty	UOM																																																																														
TB3009B0	TB3132A-ONE OVEN WASHING INLET	2.000	PC																																																																																	
TB3225B0	TB2820A-TAN K-WASHYNG SYS CONNECTION	2.000	PC																																																																																	
VI1220A1	4,2x12 TCB SELF-TAPPIN G SCREW	2.000	PC																																																																																	
VL1019A0	VIBRATION DETERGENT PUMP	2.000	PC																																																																																	
VL1047A1	D6 PIPE HOLDER - D8 J.G. TERMINAL	2.000	PC																																																																																	
VL1054B0	ONE WASHING SYS INLET DISTRIBUTOR	2.000	PC																																																																																	
VL1102A1	DETERGENT LINE FILTER + BARBED VNR 6 MM	2.000	PC																																																																																	
VL1127A1	6mm BARBED T-SHAPED FITTING	1.000	PC																																																																																	
VL1128A1	D6 BARBED CHECK VALVE	4.000	PC																																																																																	
VL1166A0	BB6-AR6 L FITTING	2.000	PC																																																																																	
VL1174C0	D1.2 MM CALIBRATED D1.2 MM	2.000	PC																																																																																	
VL1191A0	ONE WASHING DISTRIBUTOR OUTLETS KIT	2.000	PC																																																																																	
VL1214A0	BAYONET - 6mm BARBED NRV VALVE	2.000	PC																																																																																	
VM2172A0	LOCKING CLIP FOR PUMP WITH CIRCUIT	4.000	PC																																																																																	
Code	Description	Qty	UOM																																																																																	
0H2213A1	HOOD WATER CIRCUIT PLAT	1.000	PC																																																																																	
EL1450A0	US SELF-CLEANIN G WATER SOLENOID	2.000	PC																																																																																	
GN1526A0	INT. D.=6.9 TH=1.8 O-RIN	5.000	PC																																																																																	



COMPONENT			SPARE PART			
Code	Description	Image	Code	Description	Kit components	
VL1019A	VIBRATION DETERGENT PUMP		KVL1225A	US HOOD WASHING SYSTEM KIT	Code	Description Qty UOM
					RC1018A0	ZINC PLATED 4.000 PC D12 ELASTIC CLAMP
					RC1019A0	D=10 ELASTIC 16.000 PC CLAMP
					RC1131A0	200x2.6 BLACK 1.000 PC CLAMP
					RC1242A0	D=10 CLOSED 2.000 PC CAP
					TB2821A0	EPDM 6X10 6.000 PC L=40MM PIPE
					TB2994A0	HOOD 2.000 PC DETERGENT PIPE
					TB3252A0	TB3252A0 2.000 PC
					VI1220A1	4,2x12 TCB 3.000 PC SELF-TAPPIN G SCREW
					VL1019A0	VIBRATION 1.000 PC DETERGENT PUMP
					VL1047A1	D6 PIPE 1.000 PC HOLDER - D8 J.G. TERMINAL
					VL1054B0	ONE 1.000 PC WASHING SYS INLET DISTRIBUTOR
					VL1102A1	DETERGENT 1.000 PC LINE FILTER + BARBED VNR 6 MM
					VL1127A1	6mm BARBED 1.000 PC T-SHAPED FITTING
					VL1128A1	D6 BARBED 2.000 PC CHECK VALVE
					VL1165A0	BAM-BB6 1.000 PC STRAIGHT FITTING
					VL1166A0	BB6-AR6 L 2.000 PC FITTING
					VL1174C0	D1.2 MM 1.000 PC CALIBRATED D1.2 MM
					VL1191A0	ONE 1.000 PC WASHING DISTRIBUTOR OUTLETS KIT
					VL1214A0	BAYONET - 1.000 PC 6mm BARBED NRV VALVE
					VM1605A0	CLIP TWIST 2.000 PC LOCK DIAM. 10,2-12,7 MM
					VM2172A0	LOCKING CLIP 3.000 PC FOR PUMP WITH CIRCUIT

COMPONENT			SPARE PART																																																																														
Code	Description	Image	Code	Description	Kit components																																																																												
VL1019A	VIBRATION DETERGENT PUMP		KVL1222A	EUR 0311 ONE PLUS CLEANING SYSTEM KIT	<table border="1"> <thead> <tr> <th>Code</th> <th>Description</th> <th>Qty</th> <th>UOM</th> </tr> </thead> <tbody> <tr> <td>0H2486A0</td> <td>0311 WASHING CIRCUIT PLAT</td> <td>1.000</td> <td>PC</td> </tr> <tr> <td>EL1440A0</td> <td>WATER SELF CLEANING VALVE</td> <td>1.000</td> <td>PC</td> </tr> <tr> <td>GN1526A0</td> <td>INT. D.=6.9 TH=1.8 O-RIN</td> <td>3.000</td> <td>PC</td> </tr> <tr> <td>RC1018A0</td> <td>ZINC PLATED D12 ELASTIC CLAMP</td> <td>1.000</td> <td>PC</td> </tr> <tr> <td>RC1019A0</td> <td>D=10 ELASTIC CLAMP</td> <td>14.000</td> <td>PC</td> </tr> <tr> <td>RC1242A0</td> <td>D=10 CLOSED CAP</td> <td>2.000</td> <td>PC</td> </tr> <tr> <td>TB2821A0</td> <td>EPDM 6X10 L=40MM PIPE</td> <td>6.000</td> <td>PC</td> </tr> <tr> <td>TB3004A0</td> <td>TB2820A L=550mm EPDM BLACK PIPE</td> <td>1.000</td> <td>PC</td> </tr> <tr> <td>TB3009B0</td> <td>TB3132A-ONE OVEN WASHING INLET</td> <td>1.000</td> <td>PC</td> </tr> <tr> <td>TB3225B0</td> <td>TB2820A-TAN K-WASHYNG SYS CONNECTION</td> <td>1.000</td> <td>PC</td> </tr> <tr> <td>VI1220A1</td> <td>4,2x12 TCB SELF-TAPPIN G SCREW</td> <td>4.000</td> <td>PC</td> </tr> <tr> <td>VL1019A0</td> <td>VIBRATION DETERGENT PUMP</td> <td>1.000</td> <td>PC</td> </tr> <tr> <td>VL1047A1</td> <td>D6 PIPE HOLDER - D6 J.G. TERMINAL</td> <td>1.000</td> <td>PC</td> </tr> <tr> <td>VL1054B0</td> <td>ONE WASHING SYS INLET DISTRIBUTOR</td> <td>1.000</td> <td>PC</td> </tr> <tr> <td>VL1102A1</td> <td>DETERGENT LINE FILTER + BARBED VNR 6 MM</td> <td>1.000</td> <td>PC</td> </tr> <tr> <td>VL1128A1</td> <td>D6 BARBED CHECK VALVE</td> <td>2.000</td> <td>PC</td> </tr> <tr> <td>VL1166A0</td> <td>BB6-AR6 L FITTING</td> <td>1.000</td> <td>PC</td> </tr> <tr> <td>VL1174C0</td> <td>D1.2 MM CALIBRATED D1.2 MM</td> <td>1.000</td> <td>PC</td> </tr> </tbody> </table>	Code	Description	Qty	UOM	0H2486A0	0311 WASHING CIRCUIT PLAT	1.000	PC	EL1440A0	WATER SELF CLEANING VALVE	1.000	PC	GN1526A0	INT. D.=6.9 TH=1.8 O-RIN	3.000	PC	RC1018A0	ZINC PLATED D12 ELASTIC CLAMP	1.000	PC	RC1019A0	D=10 ELASTIC CLAMP	14.000	PC	RC1242A0	D=10 CLOSED CAP	2.000	PC	TB2821A0	EPDM 6X10 L=40MM PIPE	6.000	PC	TB3004A0	TB2820A L=550mm EPDM BLACK PIPE	1.000	PC	TB3009B0	TB3132A-ONE OVEN WASHING INLET	1.000	PC	TB3225B0	TB2820A-TAN K-WASHYNG SYS CONNECTION	1.000	PC	VI1220A1	4,2x12 TCB SELF-TAPPIN G SCREW	4.000	PC	VL1019A0	VIBRATION DETERGENT PUMP	1.000	PC	VL1047A1	D6 PIPE HOLDER - D6 J.G. TERMINAL	1.000	PC	VL1054B0	ONE WASHING SYS INLET DISTRIBUTOR	1.000	PC	VL1102A1	DETERGENT LINE FILTER + BARBED VNR 6 MM	1.000	PC	VL1128A1	D6 BARBED CHECK VALVE	2.000	PC	VL1166A0	BB6-AR6 L FITTING	1.000	PC	VL1174C0	D1.2 MM CALIBRATED D1.2 MM	1.000	PC
Code	Description	Qty	UOM																																																																														
0H2486A0	0311 WASHING CIRCUIT PLAT	1.000	PC																																																																														
EL1440A0	WATER SELF CLEANING VALVE	1.000	PC																																																																														
GN1526A0	INT. D.=6.9 TH=1.8 O-RIN	3.000	PC																																																																														
RC1018A0	ZINC PLATED D12 ELASTIC CLAMP	1.000	PC																																																																														
RC1019A0	D=10 ELASTIC CLAMP	14.000	PC																																																																														
RC1242A0	D=10 CLOSED CAP	2.000	PC																																																																														
TB2821A0	EPDM 6X10 L=40MM PIPE	6.000	PC																																																																														
TB3004A0	TB2820A L=550mm EPDM BLACK PIPE	1.000	PC																																																																														
TB3009B0	TB3132A-ONE OVEN WASHING INLET	1.000	PC																																																																														
TB3225B0	TB2820A-TAN K-WASHYNG SYS CONNECTION	1.000	PC																																																																														
VI1220A1	4,2x12 TCB SELF-TAPPIN G SCREW	4.000	PC																																																																														
VL1019A0	VIBRATION DETERGENT PUMP	1.000	PC																																																																														
VL1047A1	D6 PIPE HOLDER - D6 J.G. TERMINAL	1.000	PC																																																																														
VL1054B0	ONE WASHING SYS INLET DISTRIBUTOR	1.000	PC																																																																														
VL1102A1	DETERGENT LINE FILTER + BARBED VNR 6 MM	1.000	PC																																																																														
VL1128A1	D6 BARBED CHECK VALVE	2.000	PC																																																																														
VL1166A0	BB6-AR6 L FITTING	1.000	PC																																																																														
VL1174C0	D1.2 MM CALIBRATED D1.2 MM	1.000	PC																																																																														



COMPONENT			SPARE PART																																																															
Code	Description	Image	Code	Description	Kit components																																																													
VL1019A	VIBRATION DETERGENT PUMP		KVL1222A	EUR 0311 ONE PLUS CLEANING SYSTEM KIT	<table border="1"> <thead> <tr> <th>Code</th> <th>Description</th> <th>Qty</th> <th>UOM</th> </tr> </thead> <tbody> <tr> <td>VL1191A0</td> <td>ONE WASHING DISTRIBUTOR OUTLETS KIT</td> <td>1.000</td> <td>PC</td> </tr> <tr> <td>VL1214A0</td> <td>BAYONET - 6mm BARBED NRV VALVE</td> <td>1.000</td> <td>PC</td> </tr> <tr> <td>VM2172A0</td> <td>LOCKING CLIP FOR PUMP WITH CIRCUIT</td> <td>2.000</td> <td>PC</td> </tr> </tbody> </table>	Code	Description	Qty	UOM	VL1191A0	ONE WASHING DISTRIBUTOR OUTLETS KIT	1.000	PC	VL1214A0	BAYONET - 6mm BARBED NRV VALVE	1.000	PC	VM2172A0	LOCKING CLIP FOR PUMP WITH CIRCUIT	2.000	PC																																													
			Code	Description	Qty	UOM																																																												
VL1191A0	ONE WASHING DISTRIBUTOR OUTLETS KIT	1.000	PC																																																															
VL1214A0	BAYONET - 6mm BARBED NRV VALVE	1.000	PC																																																															
VM2172A0	LOCKING CLIP FOR PUMP WITH CIRCUIT	2.000	PC																																																															
KVL1213A	US PLUS COMPACT WASHING SYSTEM KIT	<table border="1"> <thead> <tr> <th>Code</th> <th>Description</th> <th>Qty</th> <th>UOM</th> </tr> </thead> <tbody> <tr> <td>0H2428A2</td> <td>XECC PLUS WASHING CIRCUIT PLAT</td> <td>1.000</td> <td>PC</td> </tr> <tr> <td>EL1450A0</td> <td>US SELF-CLEANIN G WATER SOLENOID</td> <td>3.000</td> <td>PC</td> </tr> <tr> <td>GN1312A0</td> <td>RUBBER CABLE-PASSI NG DE-26 DI=15 SP=10</td> <td>1.000</td> <td>PC</td> </tr> <tr> <td>GN1526A0</td> <td>INT. D.=6.9 TH=1.8 O-RIN</td> <td>7.000</td> <td>PC</td> </tr> <tr> <td>RC1018A0</td> <td>ZINC PLATED D12 ELASTIC CLAMP</td> <td>2.000</td> <td>PC</td> </tr> <tr> <td>RC1019A0</td> <td>D=10 ELASTIC CLAMP</td> <td>14.000</td> <td>PC</td> </tr> <tr> <td>RC1130A0</td> <td>130x2.6 CLAM</td> <td>1.000</td> <td>PC</td> </tr> <tr> <td>RC1131A0</td> <td>200x2.6 BLACK CLAMP</td> <td>1.000</td> <td>PC</td> </tr> <tr> <td>RC1242A0</td> <td>D=10 CLOSED CAP</td> <td>2.000</td> <td>PC</td> </tr> <tr> <td>RC1356A0</td> <td>"STRAIGHT THREADED FEMALE END 8x1/4" BS</td> <td>1.000</td> <td>PC</td> </tr> <tr> <td>TB2821A0</td> <td>EPDM 6X10 L=40MM PIPE</td> <td>6.000</td> <td>PC</td> </tr> <tr> <td>TB3004A0</td> <td>TB2820A L=550mm EPDM BLACK PIPE</td> <td>1.000</td> <td>PC</td> </tr> <tr> <td>TB3005B0</td> <td>TB3132A L=550mm EPDM WHITE-BLUE PIPE</td> <td>1.000</td> <td>PC</td> </tr> <tr> <td>TB3469A0</td> <td></td> <td>1.000</td> <td>PC</td> </tr> <tr> <td>VL1019A0</td> <td>VIBRATION DETERGENT PUMP</td> <td>1.000</td> <td>PC</td> </tr> </tbody> </table>	Code	Description	Qty	UOM	0H2428A2	XECC PLUS WASHING CIRCUIT PLAT	1.000	PC	EL1450A0	US SELF-CLEANIN G WATER SOLENOID	3.000	PC	GN1312A0	RUBBER CABLE-PASSI NG DE-26 DI=15 SP=10	1.000	PC	GN1526A0	INT. D.=6.9 TH=1.8 O-RIN	7.000	PC	RC1018A0	ZINC PLATED D12 ELASTIC CLAMP	2.000	PC	RC1019A0	D=10 ELASTIC CLAMP	14.000	PC	RC1130A0	130x2.6 CLAM	1.000	PC	RC1131A0	200x2.6 BLACK CLAMP	1.000	PC	RC1242A0	D=10 CLOSED CAP	2.000	PC	RC1356A0	"STRAIGHT THREADED FEMALE END 8x1/4" BS	1.000	PC	TB2821A0	EPDM 6X10 L=40MM PIPE	6.000	PC	TB3004A0	TB2820A L=550mm EPDM BLACK PIPE	1.000	PC	TB3005B0	TB3132A L=550mm EPDM WHITE-BLUE PIPE	1.000	PC	TB3469A0		1.000	PC	VL1019A0	VIBRATION DETERGENT PUMP	1.000	PC
Code	Description	Qty	UOM																																																															
0H2428A2	XECC PLUS WASHING CIRCUIT PLAT	1.000	PC																																																															
EL1450A0	US SELF-CLEANIN G WATER SOLENOID	3.000	PC																																																															
GN1312A0	RUBBER CABLE-PASSI NG DE-26 DI=15 SP=10	1.000	PC																																																															
GN1526A0	INT. D.=6.9 TH=1.8 O-RIN	7.000	PC																																																															
RC1018A0	ZINC PLATED D12 ELASTIC CLAMP	2.000	PC																																																															
RC1019A0	D=10 ELASTIC CLAMP	14.000	PC																																																															
RC1130A0	130x2.6 CLAM	1.000	PC																																																															
RC1131A0	200x2.6 BLACK CLAMP	1.000	PC																																																															
RC1242A0	D=10 CLOSED CAP	2.000	PC																																																															
RC1356A0	"STRAIGHT THREADED FEMALE END 8x1/4" BS	1.000	PC																																																															
TB2821A0	EPDM 6X10 L=40MM PIPE	6.000	PC																																																															
TB3004A0	TB2820A L=550mm EPDM BLACK PIPE	1.000	PC																																																															
TB3005B0	TB3132A L=550mm EPDM WHITE-BLUE PIPE	1.000	PC																																																															
TB3469A0		1.000	PC																																																															
VL1019A0	VIBRATION DETERGENT PUMP	1.000	PC																																																															



COMPONENT			SPARE PART																																														
Code	Description	Image	Code	Description	Kit components																																												
VL1019A	VIBRATION DETERGENT PUMP		KVL1213A	US PLUS COMPACT WASHING SYSTEM KIT	<table border="1"> <thead> <tr> <th>Code</th> <th>Description</th> <th>Qty</th> <th>UOM</th> </tr> </thead> <tbody> <tr> <td>VL1047A1</td> <td>D6 PIPE HOLDER - D8 J.G. TERMINAL</td> <td>1.000</td> <td>PC</td> </tr> <tr> <td>VL1054B0</td> <td>ONE WASHING SYS INLET DISTRIBUTOR</td> <td>1.000</td> <td>PC</td> </tr> <tr> <td>VL1065A1</td> <td>1/4 MALE N.O. PRESSURE SWITCH</td> <td>1.000</td> <td>PC</td> </tr> <tr> <td>VL1102A1</td> <td>DETERGENT LINE FILTER + BARBED VNR 6 MM</td> <td>1.000</td> <td>PC</td> </tr> <tr> <td>VL1128A1</td> <td>D6 BARBED CHECK VALVE</td> <td>2.000</td> <td>PC</td> </tr> <tr> <td>VL1165A0</td> <td>BAM-BB6 STRAIGHT FITTING</td> <td>1.000</td> <td>PC</td> </tr> <tr> <td>VL1166A0</td> <td>BB6-AR6 L FITTING</td> <td>3.000</td> <td>PC</td> </tr> <tr> <td>VL1174C0</td> <td>D1.2 MM CALIBRATED D1.2 MM</td> <td>1.000</td> <td>PC</td> </tr> <tr> <td>VL1185A0</td> <td>2 WAYS PLUS WASHING DISTRIBUTOR</td> <td>1.000</td> <td>PC</td> </tr> <tr> <td>VM2172A0</td> <td>LOCKING CLIP FOR PUMP WITH CIRCUIT</td> <td>6.000</td> <td>PC</td> </tr> </tbody> </table>	Code	Description	Qty	UOM	VL1047A1	D6 PIPE HOLDER - D8 J.G. TERMINAL	1.000	PC	VL1054B0	ONE WASHING SYS INLET DISTRIBUTOR	1.000	PC	VL1065A1	1/4 MALE N.O. PRESSURE SWITCH	1.000	PC	VL1102A1	DETERGENT LINE FILTER + BARBED VNR 6 MM	1.000	PC	VL1128A1	D6 BARBED CHECK VALVE	2.000	PC	VL1165A0	BAM-BB6 STRAIGHT FITTING	1.000	PC	VL1166A0	BB6-AR6 L FITTING	3.000	PC	VL1174C0	D1.2 MM CALIBRATED D1.2 MM	1.000	PC	VL1185A0	2 WAYS PLUS WASHING DISTRIBUTOR	1.000	PC	VM2172A0	LOCKING CLIP FOR PUMP WITH CIRCUIT	6.000	PC
			Code	Description	Qty	UOM																																											
VL1047A1	D6 PIPE HOLDER - D8 J.G. TERMINAL	1.000	PC																																														
VL1054B0	ONE WASHING SYS INLET DISTRIBUTOR	1.000	PC																																														
VL1065A1	1/4 MALE N.O. PRESSURE SWITCH	1.000	PC																																														
VL1102A1	DETERGENT LINE FILTER + BARBED VNR 6 MM	1.000	PC																																														
VL1128A1	D6 BARBED CHECK VALVE	2.000	PC																																														
VL1165A0	BAM-BB6 STRAIGHT FITTING	1.000	PC																																														
VL1166A0	BB6-AR6 L FITTING	3.000	PC																																														
VL1174C0	D1.2 MM CALIBRATED D1.2 MM	1.000	PC																																														
VL1185A0	2 WAYS PLUS WASHING DISTRIBUTOR	1.000	PC																																														
VM2172A0	LOCKING CLIP FOR PUMP WITH CIRCUIT	6.000	PC																																														
KVL1212A	EUR COMPACT PLUS CLEANING SYSTEM KIT	<table border="1"> <thead> <tr> <th>Code</th> <th>Description</th> <th>Qty</th> <th>UOM</th> </tr> </thead> <tbody> <tr> <td>0H2428A2</td> <td>XECC PLUS WASHING CIRCUIT PLAT</td> <td>1.000</td> <td>PC</td> </tr> <tr> <td>EL1440A0</td> <td>WATER SELF CLEANING VALVE</td> <td>3.000</td> <td>PC</td> </tr> <tr> <td>GN1312A0</td> <td>RUBBER CABLE-PASSI NG DE=26 DI=15 SP=10</td> <td>1.000</td> <td>PC</td> </tr> <tr> <td>GN1526A0</td> <td>INT. D.=6.9 TH=1.8 O-RIN</td> <td>7.000</td> <td>PC</td> </tr> <tr> <td>RC1018A0</td> <td>ZINC PLATED D12 ELASTIC CLAMP</td> <td>2.000</td> <td>PC</td> </tr> <tr> <td>RC1019A0</td> <td>D=10 ELASTIC CLAMP</td> <td>14.000</td> <td>PC</td> </tr> <tr> <td>RC1130A0</td> <td>130x2,6 CLAM</td> <td>1.000</td> <td>PC</td> </tr> <tr> <td>RC1131A0</td> <td>200x2,6 BLACK CLAMP</td> <td>1.000</td> <td>PC</td> </tr> <tr> <td>RC1242A0</td> <td>D=10 CLOSED CAP</td> <td>2.000</td> <td>PC</td> </tr> </tbody> </table>	Code	Description	Qty	UOM	0H2428A2	XECC PLUS WASHING CIRCUIT PLAT	1.000	PC	EL1440A0	WATER SELF CLEANING VALVE	3.000	PC	GN1312A0	RUBBER CABLE-PASSI NG DE=26 DI=15 SP=10	1.000	PC	GN1526A0	INT. D.=6.9 TH=1.8 O-RIN	7.000	PC	RC1018A0	ZINC PLATED D12 ELASTIC CLAMP	2.000	PC	RC1019A0	D=10 ELASTIC CLAMP	14.000	PC	RC1130A0	130x2,6 CLAM	1.000	PC	RC1131A0	200x2,6 BLACK CLAMP	1.000	PC	RC1242A0	D=10 CLOSED CAP	2.000	PC							
Code	Description	Qty	UOM																																														
0H2428A2	XECC PLUS WASHING CIRCUIT PLAT	1.000	PC																																														
EL1440A0	WATER SELF CLEANING VALVE	3.000	PC																																														
GN1312A0	RUBBER CABLE-PASSI NG DE=26 DI=15 SP=10	1.000	PC																																														
GN1526A0	INT. D.=6.9 TH=1.8 O-RIN	7.000	PC																																														
RC1018A0	ZINC PLATED D12 ELASTIC CLAMP	2.000	PC																																														
RC1019A0	D=10 ELASTIC CLAMP	14.000	PC																																														
RC1130A0	130x2,6 CLAM	1.000	PC																																														
RC1131A0	200x2,6 BLACK CLAMP	1.000	PC																																														
RC1242A0	D=10 CLOSED CAP	2.000	PC																																														



COMPONENT			SPARE PART																																																																							
Code	Description	Image	Code	Description	Kit components																																																																					
VL1019A	VIBRATION DETERGENT PUMP		KVL1212A	EUR COMPACT PLUS CLEANING SYSTEM KIT	<table border="1"> <thead> <tr> <th>Code</th> <th>Description</th> <th>Qty</th> <th>UOM</th> </tr> </thead> <tbody> <tr> <td>RC1356A0</td> <td>"STRAIGHT THREADED FEMALE END 8x1/4" BS</td> <td>1.000</td> <td>PC</td> </tr> <tr> <td>TB2821A0</td> <td>EPDM 6X10 L=40MM PIPE</td> <td>6.000</td> <td>PC</td> </tr> <tr> <td>TB3004A0</td> <td>TB2820A L=550mm EPDM BLACK PIPE</td> <td>2.000</td> <td>PC</td> </tr> <tr> <td>TB3005B0</td> <td>TB3132A L=550mm EPDM WHITE-BLUE PIPE</td> <td>1.000</td> <td>PC</td> </tr> <tr> <td>TB3469A0</td> <td></td> <td>1.000</td> <td>PC</td> </tr> <tr> <td>VL1019A0</td> <td>VIBRATION DETERGENT PUMP</td> <td>1.000</td> <td>PC</td> </tr> <tr> <td>VL1047A1</td> <td>D6 PIPE HOLDER - D8 J.G. TERMINAL</td> <td>1.000</td> <td>PC</td> </tr> <tr> <td>VL1054B0</td> <td>ONE WASHING SYS INLET DISTRIBUTOR</td> <td>1.000</td> <td>PC</td> </tr> <tr> <td>VL1065A1</td> <td>1/4 MALE N.O. PRESSURE SWITCH</td> <td>1.000</td> <td>PC</td> </tr> <tr> <td>VL1102A1</td> <td>DETERGENT LINE FILTER + BARBED VNR 6 MM</td> <td>1.000</td> <td>PC</td> </tr> <tr> <td>VL1128A1</td> <td>D6 BARBED CHECK VALVE</td> <td>2.000</td> <td>PC</td> </tr> <tr> <td>VL1165A0</td> <td>BAM-BB6 STRAIGHT FITTING</td> <td>1.000</td> <td>PC</td> </tr> <tr> <td>VL1166A0</td> <td>BB6-AR6 L FITTING</td> <td>3.000</td> <td>PC</td> </tr> <tr> <td>VL1174C0</td> <td>D1.2 MM CALIBRATED D1.2 MM</td> <td>1.000</td> <td>PC</td> </tr> <tr> <td>VL1185A0</td> <td>2 WAYS PLUS WASHING DISTRIBUTOR</td> <td>1.000</td> <td>PC</td> </tr> <tr> <td>VM2172A0</td> <td>LOCKING CLIP FOR PUMP WITH CIRCUIT</td> <td>6.000</td> <td>PC</td> </tr> </tbody> </table>	Code	Description	Qty	UOM	RC1356A0	"STRAIGHT THREADED FEMALE END 8x1/4" BS	1.000	PC	TB2821A0	EPDM 6X10 L=40MM PIPE	6.000	PC	TB3004A0	TB2820A L=550mm EPDM BLACK PIPE	2.000	PC	TB3005B0	TB3132A L=550mm EPDM WHITE-BLUE PIPE	1.000	PC	TB3469A0		1.000	PC	VL1019A0	VIBRATION DETERGENT PUMP	1.000	PC	VL1047A1	D6 PIPE HOLDER - D8 J.G. TERMINAL	1.000	PC	VL1054B0	ONE WASHING SYS INLET DISTRIBUTOR	1.000	PC	VL1065A1	1/4 MALE N.O. PRESSURE SWITCH	1.000	PC	VL1102A1	DETERGENT LINE FILTER + BARBED VNR 6 MM	1.000	PC	VL1128A1	D6 BARBED CHECK VALVE	2.000	PC	VL1165A0	BAM-BB6 STRAIGHT FITTING	1.000	PC	VL1166A0	BB6-AR6 L FITTING	3.000	PC	VL1174C0	D1.2 MM CALIBRATED D1.2 MM	1.000	PC	VL1185A0	2 WAYS PLUS WASHING DISTRIBUTOR	1.000	PC	VM2172A0	LOCKING CLIP FOR PUMP WITH CIRCUIT	6.000	PC	
Code	Description	Qty	UOM																																																																							
RC1356A0	"STRAIGHT THREADED FEMALE END 8x1/4" BS	1.000	PC																																																																							
TB2821A0	EPDM 6X10 L=40MM PIPE	6.000	PC																																																																							
TB3004A0	TB2820A L=550mm EPDM BLACK PIPE	2.000	PC																																																																							
TB3005B0	TB3132A L=550mm EPDM WHITE-BLUE PIPE	1.000	PC																																																																							
TB3469A0		1.000	PC																																																																							
VL1019A0	VIBRATION DETERGENT PUMP	1.000	PC																																																																							
VL1047A1	D6 PIPE HOLDER - D8 J.G. TERMINAL	1.000	PC																																																																							
VL1054B0	ONE WASHING SYS INLET DISTRIBUTOR	1.000	PC																																																																							
VL1065A1	1/4 MALE N.O. PRESSURE SWITCH	1.000	PC																																																																							
VL1102A1	DETERGENT LINE FILTER + BARBED VNR 6 MM	1.000	PC																																																																							
VL1128A1	D6 BARBED CHECK VALVE	2.000	PC																																																																							
VL1165A0	BAM-BB6 STRAIGHT FITTING	1.000	PC																																																																							
VL1166A0	BB6-AR6 L FITTING	3.000	PC																																																																							
VL1174C0	D1.2 MM CALIBRATED D1.2 MM	1.000	PC																																																																							
VL1185A0	2 WAYS PLUS WASHING DISTRIBUTOR	1.000	PC																																																																							
VM2172A0	LOCKING CLIP FOR PUMP WITH CIRCUIT	6.000	PC																																																																							



COMPONENT			SPARE PART			
Code	Description	Image	Code	Description	Kit components	
VL1019A	VIBRATION DETERGENT PUMP		KVL1211A	ONE COMPACT AND 0523-EP WASH. SYSTEM KIT	Code	Description Qty UOM
					0H2427A0	XECC 1.000 PC WASHING CIRCUIT HOLDING PLATE
					EL1440A0	WATER SELF 1.000 PC CLEANING VALVE
					GN1526A0	INT. D.=6.9 3.000 PC TH=1.8 O-RIN
					RC1018A0	ZINC PLATED 1.000 PC D12 ELASTIC CLAMP
					RC1019A0	D=10 ELASTIC 14.000 PC CLAMP
					RC1130A0	130x2.6 CLAM 1.000 PC
					RC1242A0	D=10 CLOSED 2.000 PC CAP
					TB1402A0	TB2820A-DETE 1.000 PC RGENT CIRCUIT-FILTE R PIPE
					TB2821A0	EPDM 6X10 6.000 PC L=40MM PIPE
					TB3004A0	TB2820A 1.000 PC L=550mm EPDM BLACK PIPE
					TB3469A0	1.000 PC
					VI1220A1	4,2x12 TCB 4.000 PC SELF-TAPPIN G SCREW
					VL1019A0	VIBRATION 1.000 PC DETERGENT PUMP
					VL1047A1	D6 PIPE 1.000 PC HOLDER - D6 J.G. TERMINAL
					VL1054B0	ONE 1.000 PC WASHING SYS INLET DISTRIBUTOR
					VL1102A1	DETERGENT 1.000 PC LINE FILTER + BARBED VNR 6 MM
					VL1128A1	D6 BARBED 2.000 PC CHECK VALVE
					VL1165A0	BAM-BB6 1.000 PC STRAIGHT FITTING
					VL1166A0	BB6-AR6 L 1.000 PC FITTING



COMPONENT			SPARE PART																																																																							
Code	Description	Image	Code	Description	Kit components																																																																					
VL1019A	VIBRATION DETERGENT PUMP		KVL1211A	ONE COMPACT AND 0523-EP WASH. SYSTEM KIT	<table border="1"> <thead> <tr> <th>Code</th> <th>Description</th> <th>Qty</th> <th>UOM</th> </tr> </thead> <tbody> <tr> <td>VL1174C0</td> <td>D1.2 MM CALIBRATED D1.2 MM</td> <td>1.000</td> <td>PC</td> </tr> <tr> <td>VL1191A0</td> <td>ONE WASHING DISTRIBUTOR OUTLETS KIT</td> <td>1.000</td> <td>PC</td> </tr> <tr> <td>VM2172A0</td> <td>LOCKING CLIP FOR PUMP WITH CIRCUIT</td> <td>2.000</td> <td>PC</td> </tr> </tbody> </table>	Code	Description	Qty	UOM	VL1174C0	D1.2 MM CALIBRATED D1.2 MM	1.000	PC	VL1191A0	ONE WASHING DISTRIBUTOR OUTLETS KIT	1.000	PC	VM2172A0	LOCKING CLIP FOR PUMP WITH CIRCUIT	2.000	PC																																																					
			Code	Description	Qty	UOM																																																																				
VL1174C0	D1.2 MM CALIBRATED D1.2 MM	1.000	PC																																																																							
VL1191A0	ONE WASHING DISTRIBUTOR OUTLETS KIT	1.000	PC																																																																							
VM2172A0	LOCKING CLIP FOR PUMP WITH CIRCUIT	2.000	PC																																																																							
KVL1209A	US PLUS 3 ROTOR ARMS WASHING SYSTEM KIT	<table border="1"> <thead> <tr> <th>Code</th> <th>Description</th> <th>Qty</th> <th>UOM</th> </tr> </thead> <tbody> <tr> <td>0H2354A1</td> <td>XEVC-XEVL PLUS WASHING CIRCUIT PLAT</td> <td>1.000</td> <td>PC</td> </tr> <tr> <td>EL1450A0</td> <td>US SELF-CLEANIN G WATER SOLENOID</td> <td>4.000</td> <td>PC</td> </tr> <tr> <td>GN1526A0</td> <td>INT. D.=6.9 TH=1.8 O-RIN</td> <td>9.000</td> <td>PC</td> </tr> <tr> <td>RC1018A0</td> <td>ZINC PLATED D12 ELASTIC CLAMP</td> <td>12.000</td> <td>PC</td> </tr> <tr> <td>RC1019A0</td> <td>D=10 ELASTIC CLAMP</td> <td>15.000</td> <td>PC</td> </tr> <tr> <td>RC1130A0</td> <td>130x2.6 CLAM</td> <td>1.000</td> <td>PC</td> </tr> <tr> <td>RC1131A0</td> <td>200x2.6 BLACK CLAMP</td> <td>3.000</td> <td>PC</td> </tr> <tr> <td>RC1242A0</td> <td>D=10 CLOSED CAP</td> <td>2.000</td> <td>PC</td> </tr> <tr> <td>RC1356A0</td> <td>"STRAIGHT THREADED FEMALE END 8x1/4" BS</td> <td>1.000</td> <td>PC</td> </tr> <tr> <td>TB2652A0</td> <td></td> <td>1.000</td> <td>PC</td> </tr> <tr> <td>TB2677A0</td> <td></td> <td>1.000</td> <td>PC</td> </tr> <tr> <td>TB2821A0</td> <td>EPDM 6X10 L=40MM PIPE</td> <td>6.000</td> <td>PC</td> </tr> <tr> <td>TB3004A0</td> <td>TB2820A L=550mm EPDM BLACK PIPE</td> <td>2.000</td> <td>PC</td> </tr> <tr> <td>TB3024C0</td> <td></td> <td>3.000</td> <td>PC</td> </tr> <tr> <td>TB3226A0</td> <td></td> <td>1.000</td> <td>PC</td> </tr> <tr> <td>TB3440A0</td> <td>TB3132A L=1050mm EPDM WHITE-BLUE PIPE</td> <td>1.000</td> <td>PC</td> </tr> <tr> <td>VL1019A0</td> <td>VIBRATION DETERGENT PUMP</td> <td>1.000</td> <td>PC</td> </tr> </tbody> </table>	Code	Description	Qty	UOM	0H2354A1	XEVC-XEVL PLUS WASHING CIRCUIT PLAT	1.000	PC	EL1450A0	US SELF-CLEANIN G WATER SOLENOID	4.000	PC	GN1526A0	INT. D.=6.9 TH=1.8 O-RIN	9.000	PC	RC1018A0	ZINC PLATED D12 ELASTIC CLAMP	12.000	PC	RC1019A0	D=10 ELASTIC CLAMP	15.000	PC	RC1130A0	130x2.6 CLAM	1.000	PC	RC1131A0	200x2.6 BLACK CLAMP	3.000	PC	RC1242A0	D=10 CLOSED CAP	2.000	PC	RC1356A0	"STRAIGHT THREADED FEMALE END 8x1/4" BS	1.000	PC	TB2652A0		1.000	PC	TB2677A0		1.000	PC	TB2821A0	EPDM 6X10 L=40MM PIPE	6.000	PC	TB3004A0	TB2820A L=550mm EPDM BLACK PIPE	2.000	PC	TB3024C0		3.000	PC	TB3226A0		1.000	PC	TB3440A0	TB3132A L=1050mm EPDM WHITE-BLUE PIPE	1.000	PC	VL1019A0	VIBRATION DETERGENT PUMP	1.000	PC
Code	Description	Qty	UOM																																																																							
0H2354A1	XEVC-XEVL PLUS WASHING CIRCUIT PLAT	1.000	PC																																																																							
EL1450A0	US SELF-CLEANIN G WATER SOLENOID	4.000	PC																																																																							
GN1526A0	INT. D.=6.9 TH=1.8 O-RIN	9.000	PC																																																																							
RC1018A0	ZINC PLATED D12 ELASTIC CLAMP	12.000	PC																																																																							
RC1019A0	D=10 ELASTIC CLAMP	15.000	PC																																																																							
RC1130A0	130x2.6 CLAM	1.000	PC																																																																							
RC1131A0	200x2.6 BLACK CLAMP	3.000	PC																																																																							
RC1242A0	D=10 CLOSED CAP	2.000	PC																																																																							
RC1356A0	"STRAIGHT THREADED FEMALE END 8x1/4" BS	1.000	PC																																																																							
TB2652A0		1.000	PC																																																																							
TB2677A0		1.000	PC																																																																							
TB2821A0	EPDM 6X10 L=40MM PIPE	6.000	PC																																																																							
TB3004A0	TB2820A L=550mm EPDM BLACK PIPE	2.000	PC																																																																							
TB3024C0		3.000	PC																																																																							
TB3226A0		1.000	PC																																																																							
TB3440A0	TB3132A L=1050mm EPDM WHITE-BLUE PIPE	1.000	PC																																																																							
VL1019A0	VIBRATION DETERGENT PUMP	1.000	PC																																																																							



COMPONENT			SPARE PART																																																																													
Code	Description	Image	Code	Description	Kit components																																																																											
VL1019A	VIBRATION DETERGENT PUMP		KVL1209A	US PLUS 3 ROTOR ARMS WASHING SYSTEM KIT	<table border="1"> <thead> <tr> <th>Code</th> <th>Description</th> <th>Qty</th> <th>UOM</th> </tr> </thead> <tbody> <tr> <td>VL1065A1</td> <td>1/4 MALE N.O. PRESSURE SWITCH</td> <td>1.000</td> <td>PC</td> </tr> <tr> <td>VL1102A1</td> <td>DETERGENT LINE FILTER + BARBED VNR 6 MM</td> <td>1.000</td> <td>PC</td> </tr> <tr> <td>VL1127A1</td> <td>6mm BARBED T-SHAPED FITTING</td> <td>2.000</td> <td>PC</td> </tr> <tr> <td>VL1128A1</td> <td>D6 BARBED CHECK VALVE</td> <td>3.000</td> <td>PC</td> </tr> <tr> <td>VL1166A0</td> <td>BB6-AR6 L FITTING</td> <td>4.000</td> <td>PC</td> </tr> <tr> <td>VL1167A2</td> <td>GN21 3 ROTOR ARMS B-B FLOW RESTRICTOR</td> <td>1.000</td> <td>PC</td> </tr> <tr> <td>VL1174C0</td> <td>D1.2 MM CALIBRATED D1.2 MM</td> <td>1.000</td> <td>PC</td> </tr> <tr> <td>VL1185A0</td> <td>2 WAYS PLUS WASHING DISTRIBUTOR</td> <td>1.000</td> <td>PC</td> </tr> <tr> <td>VL1186A0</td> <td>3 WAYS PLUS WASHING DISTRIBUTOR</td> <td>1.000</td> <td>PC</td> </tr> <tr> <td>VL1190A0</td> <td>PLUS WASHING SYSTEM INLET DISTRIBUTOR</td> <td>1.000</td> <td>PC</td> </tr> <tr> <td>VL1214A0</td> <td>BAYONET - 6mm BARBED NRV VALVE</td> <td>1.000</td> <td>PC</td> </tr> <tr> <td>VM1605A0</td> <td>CLIP TWIST LOCK DIAM. 10,2-12,7 MM</td> <td>3.000</td> <td>PC</td> </tr> <tr> <td>VM2172A0</td> <td>LOCKING CLIP FOR PUMP WITH CIRCUIT</td> <td>9.000</td> <td>PC</td> </tr> </tbody> </table>	Code	Description	Qty	UOM	VL1065A1	1/4 MALE N.O. PRESSURE SWITCH	1.000	PC	VL1102A1	DETERGENT LINE FILTER + BARBED VNR 6 MM	1.000	PC	VL1127A1	6mm BARBED T-SHAPED FITTING	2.000	PC	VL1128A1	D6 BARBED CHECK VALVE	3.000	PC	VL1166A0	BB6-AR6 L FITTING	4.000	PC	VL1167A2	GN21 3 ROTOR ARMS B-B FLOW RESTRICTOR	1.000	PC	VL1174C0	D1.2 MM CALIBRATED D1.2 MM	1.000	PC	VL1185A0	2 WAYS PLUS WASHING DISTRIBUTOR	1.000	PC	VL1186A0	3 WAYS PLUS WASHING DISTRIBUTOR	1.000	PC	VL1190A0	PLUS WASHING SYSTEM INLET DISTRIBUTOR	1.000	PC	VL1214A0	BAYONET - 6mm BARBED NRV VALVE	1.000	PC	VM1605A0	CLIP TWIST LOCK DIAM. 10,2-12,7 MM	3.000	PC	VM2172A0	LOCKING CLIP FOR PUMP WITH CIRCUIT	9.000	PC	KVL1208A	US PLUS 2 ROTOR ARMS WASHING SYSTEM KIT	<table border="1"> <thead> <tr> <th>Code</th> <th>Description</th> <th>Qty</th> <th>UOM</th> </tr> </thead> <tbody> <tr> <td>0H2354A1</td> <td>XEVC-XEVL PLUS WASHING CIRCUIT PLAT</td> <td>1.000</td> <td>PC</td> </tr> <tr> <td>EL1450A0</td> <td>US SELF-CLEANIN G WATER SOLENOID</td> <td>4.000</td> <td>PC</td> </tr> <tr> <td>GN1526A0</td> <td>INT. D.=6.9 TH=1.8 O-RIN</td> <td>9.000</td> <td>PC</td> </tr> </tbody> </table>	Code	Description	Qty	UOM	0H2354A1	XEVC-XEVL PLUS WASHING CIRCUIT PLAT	1.000	PC	EL1450A0	US SELF-CLEANIN G WATER SOLENOID	4.000	PC	GN1526A0	INT. D.=6.9 TH=1.8 O-RIN	9.000	PC
			Code	Description	Qty	UOM																																																																										
VL1065A1	1/4 MALE N.O. PRESSURE SWITCH	1.000	PC																																																																													
VL1102A1	DETERGENT LINE FILTER + BARBED VNR 6 MM	1.000	PC																																																																													
VL1127A1	6mm BARBED T-SHAPED FITTING	2.000	PC																																																																													
VL1128A1	D6 BARBED CHECK VALVE	3.000	PC																																																																													
VL1166A0	BB6-AR6 L FITTING	4.000	PC																																																																													
VL1167A2	GN21 3 ROTOR ARMS B-B FLOW RESTRICTOR	1.000	PC																																																																													
VL1174C0	D1.2 MM CALIBRATED D1.2 MM	1.000	PC																																																																													
VL1185A0	2 WAYS PLUS WASHING DISTRIBUTOR	1.000	PC																																																																													
VL1186A0	3 WAYS PLUS WASHING DISTRIBUTOR	1.000	PC																																																																													
VL1190A0	PLUS WASHING SYSTEM INLET DISTRIBUTOR	1.000	PC																																																																													
VL1214A0	BAYONET - 6mm BARBED NRV VALVE	1.000	PC																																																																													
VM1605A0	CLIP TWIST LOCK DIAM. 10,2-12,7 MM	3.000	PC																																																																													
VM2172A0	LOCKING CLIP FOR PUMP WITH CIRCUIT	9.000	PC																																																																													
Code	Description	Qty	UOM																																																																													
0H2354A1	XEVC-XEVL PLUS WASHING CIRCUIT PLAT	1.000	PC																																																																													
EL1450A0	US SELF-CLEANIN G WATER SOLENOID	4.000	PC																																																																													
GN1526A0	INT. D.=6.9 TH=1.8 O-RIN	9.000	PC																																																																													



COMPONENT			SPARE PART																																																																														
Code	Description	Image	Code	Description	Kit components																																																																												
VL1019A	VIBRATION DETERGENT PUMP		KVL1208A	US PLUS 2 ROTOR ARMS WASHING SYSTEM KIT	<table border="1"> <thead> <tr> <th>Code</th> <th>Description</th> <th>Qty</th> <th>UOM</th> </tr> </thead> <tbody> <tr> <td>RC1018A0</td> <td>ZINC PLATED D12 ELASTIC CLAMP</td> <td>3.000</td> <td>PC</td> </tr> <tr> <td>RC1019A0</td> <td>D=10 ELASTIC CLAMP</td> <td>2.000</td> <td>PC</td> </tr> <tr> <td>RC1130A0</td> <td>130x2,6 CLAM</td> <td>1.000</td> <td>PC</td> </tr> <tr> <td>RC1131A0</td> <td>200x2,6 BLACK CLAMP</td> <td>3.000</td> <td>PC</td> </tr> <tr> <td>RC1242A0</td> <td>D=10 CLOSED CAP</td> <td>2.000</td> <td>PC</td> </tr> <tr> <td>RC1356A0</td> <td>"STRAIGHT THREADED FEMALE END 8x1/4" BS</td> <td>1.000</td> <td>PC</td> </tr> <tr> <td>TB2821A0</td> <td>EPDM 6X10 L=40MM PIPE</td> <td>6.000</td> <td>PC</td> </tr> <tr> <td>TB2994A0</td> <td>HOOD DETERGENT PIPE</td> <td>1.000</td> <td>PC</td> </tr> <tr> <td>TB3004A0</td> <td>TB2820A L=550mm EPDM BLACK PIPE</td> <td>1.000</td> <td>PC</td> </tr> <tr> <td>TB3005B0</td> <td>TB3132A L=550mm EPDM WHITE-BLUE PIPE</td> <td>1.000</td> <td>PC</td> </tr> <tr> <td>TB3440A0</td> <td>TB3132A L=1050mm EPDM WHITE-BLUE PIPE</td> <td>1.000</td> <td>PC</td> </tr> <tr> <td>VL1019A0</td> <td>VIBRATION DETERGENT PUMP</td> <td>1.000</td> <td>PC</td> </tr> <tr> <td>VL1047A1</td> <td>D6 PIPE HOLDER - D8 J.G. TERMINAL</td> <td>1.000</td> <td>PC</td> </tr> <tr> <td>VL1065A1</td> <td>1/4 MALE N.O. PRESSURE SWITCH</td> <td>1.000</td> <td>PC</td> </tr> <tr> <td>VL1102A1</td> <td>DETERGENT LINE FILTER + BARBED VNR 6 MM</td> <td>1.000</td> <td>PC</td> </tr> <tr> <td>VL1128A1</td> <td>D6 BARBED CHECK VALVE</td> <td>2.000</td> <td>PC</td> </tr> <tr> <td>VL1141A1</td> <td>BB6-BB6 STRAIGHT CONNECTION</td> <td>1.000</td> <td>PC</td> </tr> <tr> <td>VL1166A0</td> <td>BB6-AR6 L FITTING</td> <td>4.000</td> <td>PC</td> </tr> </tbody> </table>	Code	Description	Qty	UOM	RC1018A0	ZINC PLATED D12 ELASTIC CLAMP	3.000	PC	RC1019A0	D=10 ELASTIC CLAMP	2.000	PC	RC1130A0	130x2,6 CLAM	1.000	PC	RC1131A0	200x2,6 BLACK CLAMP	3.000	PC	RC1242A0	D=10 CLOSED CAP	2.000	PC	RC1356A0	"STRAIGHT THREADED FEMALE END 8x1/4" BS	1.000	PC	TB2821A0	EPDM 6X10 L=40MM PIPE	6.000	PC	TB2994A0	HOOD DETERGENT PIPE	1.000	PC	TB3004A0	TB2820A L=550mm EPDM BLACK PIPE	1.000	PC	TB3005B0	TB3132A L=550mm EPDM WHITE-BLUE PIPE	1.000	PC	TB3440A0	TB3132A L=1050mm EPDM WHITE-BLUE PIPE	1.000	PC	VL1019A0	VIBRATION DETERGENT PUMP	1.000	PC	VL1047A1	D6 PIPE HOLDER - D8 J.G. TERMINAL	1.000	PC	VL1065A1	1/4 MALE N.O. PRESSURE SWITCH	1.000	PC	VL1102A1	DETERGENT LINE FILTER + BARBED VNR 6 MM	1.000	PC	VL1128A1	D6 BARBED CHECK VALVE	2.000	PC	VL1141A1	BB6-BB6 STRAIGHT CONNECTION	1.000	PC	VL1166A0	BB6-AR6 L FITTING	4.000	PC
					Code	Description	Qty	UOM																																																																									
					RC1018A0	ZINC PLATED D12 ELASTIC CLAMP	3.000	PC																																																																									
					RC1019A0	D=10 ELASTIC CLAMP	2.000	PC																																																																									
					RC1130A0	130x2,6 CLAM	1.000	PC																																																																									
					RC1131A0	200x2,6 BLACK CLAMP	3.000	PC																																																																									
					RC1242A0	D=10 CLOSED CAP	2.000	PC																																																																									
					RC1356A0	"STRAIGHT THREADED FEMALE END 8x1/4" BS	1.000	PC																																																																									
					TB2821A0	EPDM 6X10 L=40MM PIPE	6.000	PC																																																																									
					TB2994A0	HOOD DETERGENT PIPE	1.000	PC																																																																									
					TB3004A0	TB2820A L=550mm EPDM BLACK PIPE	1.000	PC																																																																									
					TB3005B0	TB3132A L=550mm EPDM WHITE-BLUE PIPE	1.000	PC																																																																									
					TB3440A0	TB3132A L=1050mm EPDM WHITE-BLUE PIPE	1.000	PC																																																																									
					VL1019A0	VIBRATION DETERGENT PUMP	1.000	PC																																																																									
					VL1047A1	D6 PIPE HOLDER - D8 J.G. TERMINAL	1.000	PC																																																																									
					VL1065A1	1/4 MALE N.O. PRESSURE SWITCH	1.000	PC																																																																									
					VL1102A1	DETERGENT LINE FILTER + BARBED VNR 6 MM	1.000	PC																																																																									
					VL1128A1	D6 BARBED CHECK VALVE	2.000	PC																																																																									
					VL1141A1	BB6-BB6 STRAIGHT CONNECTION	1.000	PC																																																																									
					VL1166A0	BB6-AR6 L FITTING	4.000	PC																																																																									





COMPONENT			SPARE PART																																															
Code	Description	Image	Code	Description	Kit components																																													
VL1019A	VIBRATION DETERGENT PUMP		KVL1208A	US PLUS 2 ROTOR ARMS WASHING SYSTEM KIT	<table border="1"> <thead> <tr> <th>Code</th> <th>Description</th> <th>Qty</th> <th>UOM</th> </tr> </thead> <tbody> <tr> <td>VL1174C0</td> <td>D1.2 MM CALIBRATED D1.2 MM</td> <td>1.000</td> <td>PC</td> </tr> <tr> <td>VL1186A0</td> <td>3 WAYS PLUS WASHING DISTRIBUTOR</td> <td>1.000</td> <td>PC</td> </tr> <tr> <td>VL1190A0</td> <td>PLUS WASHING SYSTEM INLET DISTRIBUTOR</td> <td>1.000</td> <td>PC</td> </tr> <tr> <td>VL1214A0</td> <td>BAYONET - 6mm BARBED NRV VALVE</td> <td>1.000</td> <td>PC</td> </tr> <tr> <td>VM1605A0</td> <td>CLIP TWIST LOCK DIAM. 10,2-12,7 MM</td> <td>3.000</td> <td>PC</td> </tr> <tr> <td>VM2172A0</td> <td>LOCKING CLIP FOR PUMP WITH CIRCUIT</td> <td>5.000</td> <td>PC</td> </tr> </tbody> </table>	Code	Description	Qty	UOM	VL1174C0	D1.2 MM CALIBRATED D1.2 MM	1.000	PC	VL1186A0	3 WAYS PLUS WASHING DISTRIBUTOR	1.000	PC	VL1190A0	PLUS WASHING SYSTEM INLET DISTRIBUTOR	1.000	PC	VL1214A0	BAYONET - 6mm BARBED NRV VALVE	1.000	PC	VM1605A0	CLIP TWIST LOCK DIAM. 10,2-12,7 MM	3.000	PC	VM2172A0	LOCKING CLIP FOR PUMP WITH CIRCUIT	5.000	PC																	
			Code	Description	Qty	UOM																																												
VL1174C0	D1.2 MM CALIBRATED D1.2 MM	1.000	PC																																															
VL1186A0	3 WAYS PLUS WASHING DISTRIBUTOR	1.000	PC																																															
VL1190A0	PLUS WASHING SYSTEM INLET DISTRIBUTOR	1.000	PC																																															
VL1214A0	BAYONET - 6mm BARBED NRV VALVE	1.000	PC																																															
VM1605A0	CLIP TWIST LOCK DIAM. 10,2-12,7 MM	3.000	PC																																															
VM2172A0	LOCKING CLIP FOR PUMP WITH CIRCUIT	5.000	PC																																															
KVL1207A	US PLUS 1 ROTOR ARM WASHING SYSTEM KIT	<table border="1"> <thead> <tr> <th>Code</th> <th>Description</th> <th>Qty</th> <th>UOM</th> </tr> </thead> <tbody> <tr> <td>0H2354A1</td> <td>XEVC-XEVL PLUS WASHING CIRCUIT PLAT</td> <td>1.000</td> <td>PC</td> </tr> <tr> <td>EL1450A0</td> <td>US SELF-CLEANIN G WATER SOLENOID</td> <td>3.000</td> <td>PC</td> </tr> <tr> <td>GN1526A0</td> <td>INT. D.=6.9 TH=1.8 O-RIN</td> <td>7.000</td> <td>PC</td> </tr> <tr> <td>RC1018A0</td> <td>ZINC PLATED D12 ELASTIC CLAMP</td> <td>2.000</td> <td>PC</td> </tr> <tr> <td>RC1019A0</td> <td>D=10 ELASTIC CLAMP</td> <td>14.000</td> <td>PC</td> </tr> <tr> <td>RC1130A0</td> <td>130x2,6 CLAM</td> <td>1.000</td> <td>PC</td> </tr> <tr> <td>RC1131A0</td> <td>200x2,6 BLACK CLAMP</td> <td>2.000</td> <td>PC</td> </tr> <tr> <td>RC1242A0</td> <td>D=10 CLOSED CAP</td> <td>2.000</td> <td>PC</td> </tr> <tr> <td>RC1356A0</td> <td>"STRAIGHT THREADED FEMALE END 8x1/4" BS</td> <td>1.000</td> <td>PC</td> </tr> <tr> <td>TB2821A0</td> <td>EPDM 6X10 L=40MM PIPE</td> <td>6.000</td> <td>PC</td> </tr> <tr> <td>TB3004A0</td> <td>TB2820A L=550mm EPDM BLACK PIPE</td> <td>1.000</td> <td>PC</td> </tr> </tbody> </table>	Code	Description	Qty	UOM	0H2354A1	XEVC-XEVL PLUS WASHING CIRCUIT PLAT	1.000	PC	EL1450A0	US SELF-CLEANIN G WATER SOLENOID	3.000	PC	GN1526A0	INT. D.=6.9 TH=1.8 O-RIN	7.000	PC	RC1018A0	ZINC PLATED D12 ELASTIC CLAMP	2.000	PC	RC1019A0	D=10 ELASTIC CLAMP	14.000	PC	RC1130A0	130x2,6 CLAM	1.000	PC	RC1131A0	200x2,6 BLACK CLAMP	2.000	PC	RC1242A0	D=10 CLOSED CAP	2.000	PC	RC1356A0	"STRAIGHT THREADED FEMALE END 8x1/4" BS	1.000	PC	TB2821A0	EPDM 6X10 L=40MM PIPE	6.000	PC	TB3004A0	TB2820A L=550mm EPDM BLACK PIPE	1.000	PC
Code	Description	Qty	UOM																																															
0H2354A1	XEVC-XEVL PLUS WASHING CIRCUIT PLAT	1.000	PC																																															
EL1450A0	US SELF-CLEANIN G WATER SOLENOID	3.000	PC																																															
GN1526A0	INT. D.=6.9 TH=1.8 O-RIN	7.000	PC																																															
RC1018A0	ZINC PLATED D12 ELASTIC CLAMP	2.000	PC																																															
RC1019A0	D=10 ELASTIC CLAMP	14.000	PC																																															
RC1130A0	130x2,6 CLAM	1.000	PC																																															
RC1131A0	200x2,6 BLACK CLAMP	2.000	PC																																															
RC1242A0	D=10 CLOSED CAP	2.000	PC																																															
RC1356A0	"STRAIGHT THREADED FEMALE END 8x1/4" BS	1.000	PC																																															
TB2821A0	EPDM 6X10 L=40MM PIPE	6.000	PC																																															
TB3004A0	TB2820A L=550mm EPDM BLACK PIPE	1.000	PC																																															





COMPONENT			SPARE PART																																																																																	
Code	Description	Image	Code	Description	Kit components																																																																															
VL1019A	VIBRATION DETERGENT PUMP		KVL1207A	US PLUS 1 ROTOR ARM WASHING SYSTEM KIT	<table border="1"> <thead> <tr> <th>Code</th> <th>Description</th> <th>Qty</th> <th>UOM</th> </tr> </thead> <tbody> <tr> <td>TB3005B0</td> <td>TB3132A L=550mm EPDM WHITE-BLUE PIPE</td> <td>1.000</td> <td>PC</td> </tr> <tr> <td>TB3225B0</td> <td>TB2820A-TAN K-WASHYNG SYS CONNECTION</td> <td>1.000</td> <td>PC</td> </tr> <tr> <td>TB3252A0</td> <td>TB3252A0</td> <td>1.000</td> <td>PC</td> </tr> <tr> <td>VL1019A0</td> <td>VIBRATION DETERGENT PUMP</td> <td>1.000</td> <td>PC</td> </tr> <tr> <td>VL1047A1</td> <td>D6 PIPE HOLDER - D8 J.G. TERMINAL</td> <td>1.000</td> <td>PC</td> </tr> <tr> <td>VL1065A1</td> <td>1/4 MALE N.O. PRESSURE SWITCH</td> <td>1.000</td> <td>PC</td> </tr> <tr> <td>VL1102A1</td> <td>DETERGENT LINE FILTER + BARBED VNR 6 MM</td> <td>1.000</td> <td>PC</td> </tr> <tr> <td>VL1128A1</td> <td>D6 BARBED CHECK VALVE</td> <td>2.000</td> <td>PC</td> </tr> <tr> <td>VL1166A0</td> <td>BB6-AR6 L FITTING</td> <td>3.000</td> <td>PC</td> </tr> <tr> <td>VL1174C0</td> <td>D1.2 MM CALIBRATED D1.2 MM</td> <td>1.000</td> <td>PC</td> </tr> <tr> <td>VL1185A0</td> <td>2 WAYS PLUS WASHING DISTRIBUTOR</td> <td>1.000</td> <td>PC</td> </tr> <tr> <td>VL1190A0</td> <td>PLUS WASHING SYSTEM INLET DISTRIBUTOR</td> <td>1.000</td> <td>PC</td> </tr> <tr> <td>VL1214A0</td> <td>BAYONET - 6mm BARBED NRV VALVE</td> <td>1.000</td> <td>PC</td> </tr> <tr> <td>VM1605A0</td> <td>CLIP TWIST LOCK DIAM. 10,2-12,7 MM</td> <td>3.000</td> <td>PC</td> </tr> <tr> <td>VM2172A0</td> <td>LOCKING CLIP FOR PUMP WITH CIRCUIT</td> <td>3.000</td> <td>PC</td> </tr> </tbody> </table>	Code	Description	Qty	UOM	TB3005B0	TB3132A L=550mm EPDM WHITE-BLUE PIPE	1.000	PC	TB3225B0	TB2820A-TAN K-WASHYNG SYS CONNECTION	1.000	PC	TB3252A0	TB3252A0	1.000	PC	VL1019A0	VIBRATION DETERGENT PUMP	1.000	PC	VL1047A1	D6 PIPE HOLDER - D8 J.G. TERMINAL	1.000	PC	VL1065A1	1/4 MALE N.O. PRESSURE SWITCH	1.000	PC	VL1102A1	DETERGENT LINE FILTER + BARBED VNR 6 MM	1.000	PC	VL1128A1	D6 BARBED CHECK VALVE	2.000	PC	VL1166A0	BB6-AR6 L FITTING	3.000	PC	VL1174C0	D1.2 MM CALIBRATED D1.2 MM	1.000	PC	VL1185A0	2 WAYS PLUS WASHING DISTRIBUTOR	1.000	PC	VL1190A0	PLUS WASHING SYSTEM INLET DISTRIBUTOR	1.000	PC	VL1214A0	BAYONET - 6mm BARBED NRV VALVE	1.000	PC	VM1605A0	CLIP TWIST LOCK DIAM. 10,2-12,7 MM	3.000	PC	VM2172A0	LOCKING CLIP FOR PUMP WITH CIRCUIT	3.000	PC	KVL1198A	MM EU HOOD CLEANING SYSTEM KIT	<table border="1"> <thead> <tr> <th>Code</th> <th>Description</th> <th>Qty</th> <th>UOM</th> </tr> </thead> <tbody> <tr> <td>0H2213A1</td> <td>HOOD WATER CIRCUIT PLAT</td> <td>1.000</td> <td>PC</td> </tr> <tr> <td>EL1440A0</td> <td>WATER SELF CLEANING VALVE</td> <td>2.000</td> <td>PC</td> </tr> </tbody> </table>	Code	Description	Qty	UOM	0H2213A1	HOOD WATER CIRCUIT PLAT	1.000	PC	EL1440A0	WATER SELF CLEANING VALVE	2.000	PC
			Code	Description	Qty	UOM																																																																														
TB3005B0	TB3132A L=550mm EPDM WHITE-BLUE PIPE	1.000	PC																																																																																	
TB3225B0	TB2820A-TAN K-WASHYNG SYS CONNECTION	1.000	PC																																																																																	
TB3252A0	TB3252A0	1.000	PC																																																																																	
VL1019A0	VIBRATION DETERGENT PUMP	1.000	PC																																																																																	
VL1047A1	D6 PIPE HOLDER - D8 J.G. TERMINAL	1.000	PC																																																																																	
VL1065A1	1/4 MALE N.O. PRESSURE SWITCH	1.000	PC																																																																																	
VL1102A1	DETERGENT LINE FILTER + BARBED VNR 6 MM	1.000	PC																																																																																	
VL1128A1	D6 BARBED CHECK VALVE	2.000	PC																																																																																	
VL1166A0	BB6-AR6 L FITTING	3.000	PC																																																																																	
VL1174C0	D1.2 MM CALIBRATED D1.2 MM	1.000	PC																																																																																	
VL1185A0	2 WAYS PLUS WASHING DISTRIBUTOR	1.000	PC																																																																																	
VL1190A0	PLUS WASHING SYSTEM INLET DISTRIBUTOR	1.000	PC																																																																																	
VL1214A0	BAYONET - 6mm BARBED NRV VALVE	1.000	PC																																																																																	
VM1605A0	CLIP TWIST LOCK DIAM. 10,2-12,7 MM	3.000	PC																																																																																	
VM2172A0	LOCKING CLIP FOR PUMP WITH CIRCUIT	3.000	PC																																																																																	
Code	Description	Qty	UOM																																																																																	
0H2213A1	HOOD WATER CIRCUIT PLAT	1.000	PC																																																																																	
EL1440A0	WATER SELF CLEANING VALVE	2.000	PC																																																																																	



COMPONENT			SPARE PART																																																																																						
Code	Description	Image	Code	Description	Kit components																																																																																				
VL1019A	VIBRATION DETERGENT PUMP		KVL1198A	MM EU HOOD CLEANING SYSTEM KIT	<table border="1"> <thead> <tr> <th>Code</th> <th>Description</th> <th>Qty</th> <th>UOM</th> </tr> </thead> <tbody> <tr> <td>GN1526A0</td> <td>INT. D.=6.9 TH=1.8 O-RIN</td> <td>5.000</td> <td>PC</td> </tr> <tr> <td>RC1018A0</td> <td>ZINC PLATED D12 ELASTIC CLAMP</td> <td>4.000</td> <td>PC</td> </tr> <tr> <td>RC1019A0</td> <td>D=10 ELASTIC CLAMP</td> <td>16.000</td> <td>PC</td> </tr> <tr> <td>RC1131A0</td> <td>200x2.6 BLACK CLAMP</td> <td>1.000</td> <td>PC</td> </tr> <tr> <td>RC1242A0</td> <td>D=10 CLOSED CAP</td> <td>2.000</td> <td>PC</td> </tr> <tr> <td>TB2821A0</td> <td>EPDM 6X10 L=40MM PIPE</td> <td>6.000</td> <td>PC</td> </tr> <tr> <td>TB2994A0</td> <td>HOOD DETERGENT PIPE</td> <td>2.000</td> <td>PC</td> </tr> <tr> <td>TB3252A0</td> <td>TB3252A0</td> <td>2.000</td> <td>PC</td> </tr> <tr> <td>VI1220A1</td> <td>4,2x12 TCB SELF-TAPPIN G SCREW</td> <td>3.000</td> <td>PC</td> </tr> <tr> <td>VL1019A0</td> <td>VIBRATION DETERGENT PUMP</td> <td>1.000</td> <td>PC</td> </tr> <tr> <td>VL1047A1</td> <td>D6 PIPE HOLDER - D8 J.G. TERMINAL</td> <td>2.000</td> <td>PC</td> </tr> <tr> <td>VL1054B0</td> <td>ONE WASHING SYS INLET DISTRIBUTOR</td> <td>1.000</td> <td>PC</td> </tr> <tr> <td>VL1102A1</td> <td>DETERGENT LINE FILTER + BARBED VNR 6 MM</td> <td>1.000</td> <td>PC</td> </tr> <tr> <td>VL1127A1</td> <td>6mm BARBED T-SHAPED FITTING</td> <td>1.000</td> <td>PC</td> </tr> <tr> <td>VL1128A1</td> <td>D6 BARBED CHECK VALVE</td> <td>2.000</td> <td>PC</td> </tr> <tr> <td>VL1165A0</td> <td>BAM-BB6 STRAIGHT FITTING</td> <td>1.000</td> <td>PC</td> </tr> <tr> <td>VL1166A0</td> <td>BB6-AR6 L FITTING</td> <td>2.000</td> <td>PC</td> </tr> <tr> <td>VL1174C0</td> <td>D1.2 MM CALIBRATED D1.2 MM</td> <td>1.000</td> <td>PC</td> </tr> <tr> <td>VL1191A0</td> <td>ONE WASHING DISTRIBUTOR OUTLETS KIT</td> <td>1.000</td> <td>PC</td> </tr> <tr> <td>VL1214A0</td> <td>BAYONET - 6mm BARBED NRV VALVE</td> <td>1.000</td> <td>PC</td> </tr> </tbody> </table>	Code	Description	Qty	UOM	GN1526A0	INT. D.=6.9 TH=1.8 O-RIN	5.000	PC	RC1018A0	ZINC PLATED D12 ELASTIC CLAMP	4.000	PC	RC1019A0	D=10 ELASTIC CLAMP	16.000	PC	RC1131A0	200x2.6 BLACK CLAMP	1.000	PC	RC1242A0	D=10 CLOSED CAP	2.000	PC	TB2821A0	EPDM 6X10 L=40MM PIPE	6.000	PC	TB2994A0	HOOD DETERGENT PIPE	2.000	PC	TB3252A0	TB3252A0	2.000	PC	VI1220A1	4,2x12 TCB SELF-TAPPIN G SCREW	3.000	PC	VL1019A0	VIBRATION DETERGENT PUMP	1.000	PC	VL1047A1	D6 PIPE HOLDER - D8 J.G. TERMINAL	2.000	PC	VL1054B0	ONE WASHING SYS INLET DISTRIBUTOR	1.000	PC	VL1102A1	DETERGENT LINE FILTER + BARBED VNR 6 MM	1.000	PC	VL1127A1	6mm BARBED T-SHAPED FITTING	1.000	PC	VL1128A1	D6 BARBED CHECK VALVE	2.000	PC	VL1165A0	BAM-BB6 STRAIGHT FITTING	1.000	PC	VL1166A0	BB6-AR6 L FITTING	2.000	PC	VL1174C0	D1.2 MM CALIBRATED D1.2 MM	1.000	PC	VL1191A0	ONE WASHING DISTRIBUTOR OUTLETS KIT	1.000	PC	VL1214A0	BAYONET - 6mm BARBED NRV VALVE	1.000	PC
Code	Description	Qty	UOM																																																																																						
GN1526A0	INT. D.=6.9 TH=1.8 O-RIN	5.000	PC																																																																																						
RC1018A0	ZINC PLATED D12 ELASTIC CLAMP	4.000	PC																																																																																						
RC1019A0	D=10 ELASTIC CLAMP	16.000	PC																																																																																						
RC1131A0	200x2.6 BLACK CLAMP	1.000	PC																																																																																						
RC1242A0	D=10 CLOSED CAP	2.000	PC																																																																																						
TB2821A0	EPDM 6X10 L=40MM PIPE	6.000	PC																																																																																						
TB2994A0	HOOD DETERGENT PIPE	2.000	PC																																																																																						
TB3252A0	TB3252A0	2.000	PC																																																																																						
VI1220A1	4,2x12 TCB SELF-TAPPIN G SCREW	3.000	PC																																																																																						
VL1019A0	VIBRATION DETERGENT PUMP	1.000	PC																																																																																						
VL1047A1	D6 PIPE HOLDER - D8 J.G. TERMINAL	2.000	PC																																																																																						
VL1054B0	ONE WASHING SYS INLET DISTRIBUTOR	1.000	PC																																																																																						
VL1102A1	DETERGENT LINE FILTER + BARBED VNR 6 MM	1.000	PC																																																																																						
VL1127A1	6mm BARBED T-SHAPED FITTING	1.000	PC																																																																																						
VL1128A1	D6 BARBED CHECK VALVE	2.000	PC																																																																																						
VL1165A0	BAM-BB6 STRAIGHT FITTING	1.000	PC																																																																																						
VL1166A0	BB6-AR6 L FITTING	2.000	PC																																																																																						
VL1174C0	D1.2 MM CALIBRATED D1.2 MM	1.000	PC																																																																																						
VL1191A0	ONE WASHING DISTRIBUTOR OUTLETS KIT	1.000	PC																																																																																						
VL1214A0	BAYONET - 6mm BARBED NRV VALVE	1.000	PC																																																																																						

COMPONENT			SPARE PART																																																																																
Code	Description	Image	Code	Description	Kit components																																																																														
VL1019A	VIBRATION DETERGENT PUMP		KVL1198A	MM EU HOOD CLEANING SYSTEM KIT	<table border="1"> <thead> <tr> <th>Code</th> <th>Description</th> <th>Qty</th> <th>UOM</th> </tr> </thead> <tbody> <tr> <td>VM1605A0</td> <td>CLIP TWIST LOCK DIAM. 10,2-12,7 MM</td> <td>2.000</td> <td>PC</td> </tr> <tr> <td>VM2172A0</td> <td>LOCKING CLIP FOR PUMP WITH CIRCUIT</td> <td>5.000</td> <td>PC</td> </tr> </tbody> </table>		Code	Description	Qty	UOM	VM1605A0	CLIP TWIST LOCK DIAM. 10,2-12,7 MM	2.000	PC	VM2172A0	LOCKING CLIP FOR PUMP WITH CIRCUIT	5.000	PC																																																																	
			Code	Description	Qty	UOM																																																																													
VM1605A0	CLIP TWIST LOCK DIAM. 10,2-12,7 MM	2.000	PC																																																																																
VM2172A0	LOCKING CLIP FOR PUMP WITH CIRCUIT	5.000	PC																																																																																
KVL1187A	3 ROTOR ARMS PLUS EU CLEANING SYSTEM KIT	<table border="1"> <thead> <tr> <th>Code</th> <th>Description</th> <th>Qty</th> <th>UOM</th> </tr> </thead> <tbody> <tr> <td>0H2354A1</td> <td>XEVC-XEVL PLUS WASHING CIRCUIT PLAT</td> <td>1.000</td> <td>PC</td> </tr> <tr> <td>EL1440A0</td> <td>WATER SELF CLEANING VALVE</td> <td>4.000</td> <td>PC</td> </tr> <tr> <td>GN1526A0</td> <td>INT. D.=6.9 TH=1.8 O-RIN</td> <td>9.000</td> <td>PC</td> </tr> <tr> <td>RC1018A0</td> <td>ZINC PLATED D12 ELASTIC CLAMP</td> <td>11.000</td> <td>PC</td> </tr> <tr> <td>RC1019A0</td> <td>D=10 ELASTIC CLAMP</td> <td>16.000</td> <td>PC</td> </tr> <tr> <td>RC1130A0</td> <td>130x2,6 CLAM</td> <td>1.000</td> <td>PC</td> </tr> <tr> <td>RC1131A0</td> <td>200x2,6 BLACK CLAMP</td> <td>3.000</td> <td>PC</td> </tr> <tr> <td>RC1242A0</td> <td>D=10 CLOSED CAP</td> <td>2.000</td> <td>PC</td> </tr> <tr> <td>RC1356A0</td> <td>"STRAIGHT THREADED FEMALE END 8x1/4" BS</td> <td>1.000</td> <td>PC</td> </tr> <tr> <td>TB2652A0</td> <td></td> <td>1.000</td> <td>PC</td> </tr> <tr> <td>TB2677A0</td> <td></td> <td>1.000</td> <td>PC</td> </tr> <tr> <td>TB2821A0</td> <td>EPDM 6X10 L=40MM PIPE</td> <td>6.000</td> <td>PC</td> </tr> <tr> <td>TB3004A0</td> <td>TB2820A L=550mm EPDM BLACK PIPE</td> <td>2.000</td> <td>PC</td> </tr> <tr> <td>TB3024C0</td> <td></td> <td>3.000</td> <td>PC</td> </tr> <tr> <td>TB3226A0</td> <td></td> <td>1.000</td> <td>PC</td> </tr> <tr> <td>TB3440A0</td> <td>TB3132A L=1050mm EPDM WHITE-BLUE PIPE</td> <td>1.000</td> <td>PC</td> </tr> <tr> <td>VL1019A0</td> <td>VIBRATION DETERGENT PUMP</td> <td>1.000</td> <td>PC</td> </tr> <tr> <td>VL1047A1</td> <td>D6 PIPE HOLDER - D8 J.G. TERMINAL</td> <td>1.000</td> <td>PC</td> </tr> <tr> <td>VL1065A1</td> <td>1/4 MALE N.O. PRESSURE SWITCH</td> <td>1.000</td> <td>PC</td> </tr> </tbody> </table>		Code	Description	Qty	UOM	0H2354A1	XEVC-XEVL PLUS WASHING CIRCUIT PLAT	1.000	PC	EL1440A0	WATER SELF CLEANING VALVE	4.000	PC	GN1526A0	INT. D.=6.9 TH=1.8 O-RIN	9.000	PC	RC1018A0	ZINC PLATED D12 ELASTIC CLAMP	11.000	PC	RC1019A0	D=10 ELASTIC CLAMP	16.000	PC	RC1130A0	130x2,6 CLAM	1.000	PC	RC1131A0	200x2,6 BLACK CLAMP	3.000	PC	RC1242A0	D=10 CLOSED CAP	2.000	PC	RC1356A0	"STRAIGHT THREADED FEMALE END 8x1/4" BS	1.000	PC	TB2652A0		1.000	PC	TB2677A0		1.000	PC	TB2821A0	EPDM 6X10 L=40MM PIPE	6.000	PC	TB3004A0	TB2820A L=550mm EPDM BLACK PIPE	2.000	PC	TB3024C0		3.000	PC	TB3226A0		1.000	PC	TB3440A0	TB3132A L=1050mm EPDM WHITE-BLUE PIPE	1.000	PC	VL1019A0	VIBRATION DETERGENT PUMP	1.000	PC	VL1047A1	D6 PIPE HOLDER - D8 J.G. TERMINAL	1.000	PC	VL1065A1	1/4 MALE N.O. PRESSURE SWITCH	1.000	PC
Code	Description	Qty	UOM																																																																																
0H2354A1	XEVC-XEVL PLUS WASHING CIRCUIT PLAT	1.000	PC																																																																																
EL1440A0	WATER SELF CLEANING VALVE	4.000	PC																																																																																
GN1526A0	INT. D.=6.9 TH=1.8 O-RIN	9.000	PC																																																																																
RC1018A0	ZINC PLATED D12 ELASTIC CLAMP	11.000	PC																																																																																
RC1019A0	D=10 ELASTIC CLAMP	16.000	PC																																																																																
RC1130A0	130x2,6 CLAM	1.000	PC																																																																																
RC1131A0	200x2,6 BLACK CLAMP	3.000	PC																																																																																
RC1242A0	D=10 CLOSED CAP	2.000	PC																																																																																
RC1356A0	"STRAIGHT THREADED FEMALE END 8x1/4" BS	1.000	PC																																																																																
TB2652A0		1.000	PC																																																																																
TB2677A0		1.000	PC																																																																																
TB2821A0	EPDM 6X10 L=40MM PIPE	6.000	PC																																																																																
TB3004A0	TB2820A L=550mm EPDM BLACK PIPE	2.000	PC																																																																																
TB3024C0		3.000	PC																																																																																
TB3226A0		1.000	PC																																																																																
TB3440A0	TB3132A L=1050mm EPDM WHITE-BLUE PIPE	1.000	PC																																																																																
VL1019A0	VIBRATION DETERGENT PUMP	1.000	PC																																																																																
VL1047A1	D6 PIPE HOLDER - D8 J.G. TERMINAL	1.000	PC																																																																																
VL1065A1	1/4 MALE N.O. PRESSURE SWITCH	1.000	PC																																																																																

COMPONENT			SPARE PART																																																																																					
Code	Description	Image	Code	Description	Kit components																																																																																			
VL1019A	VIBRATION DETERGENT PUMP		KVL1187A	3 ROTOR ARMS PLUS EU CLEANING SYSTEM KIT	<table border="1"> <thead> <tr> <th>Code</th> <th>Description</th> <th>Qty</th> <th>UOM</th> </tr> </thead> <tbody> <tr> <td>VL1102A1</td> <td>DETERGENT LINE FILTER + BARBED VNR 6 MM</td> <td>1.000</td> <td>PC</td> </tr> <tr> <td>VL1127A1</td> <td>6mm BARBED T-SHAPED FITTING</td> <td>2.000</td> <td>PC</td> </tr> <tr> <td>VL1128A1</td> <td>D6 BARBED CHECK VALVE</td> <td>3.000</td> <td>PC</td> </tr> <tr> <td>VL1166A0</td> <td>BB6-AR6 L FITTING</td> <td>4.000</td> <td>PC</td> </tr> <tr> <td>VL1167A2</td> <td>GN21 3 ROTOR ARMS B-B FLOW RESTRICTOR</td> <td>1.000</td> <td>PC</td> </tr> <tr> <td>VL1174C0</td> <td>D1.2 MM CALIBRATED D1.2 MM</td> <td>1.000</td> <td>PC</td> </tr> <tr> <td>VL1186A0</td> <td>3 WAYS PLUS WASHING DISTRIBUTOR</td> <td>1.000</td> <td>PC</td> </tr> <tr> <td>VL1190A0</td> <td>PLUS WASHING SYSTEM INLET DISTRIBUTOR</td> <td>1.000</td> <td>PC</td> </tr> <tr> <td>VL1214A0</td> <td>BAYONET - 6mm BARBED NRV VALVE</td> <td>1.000</td> <td>PC</td> </tr> <tr> <td>VM1605A0</td> <td>CLIP TWIST LOCK DIAM. 10,2-12,7 MM</td> <td>3.000</td> <td>PC</td> </tr> <tr> <td>VM2172A0</td> <td>LOCKING CLIP FOR PUMP WITH CIRCUIT</td> <td>5.000</td> <td>PC</td> </tr> </tbody> </table>	Code	Description	Qty	UOM	VL1102A1	DETERGENT LINE FILTER + BARBED VNR 6 MM	1.000	PC	VL1127A1	6mm BARBED T-SHAPED FITTING	2.000	PC	VL1128A1	D6 BARBED CHECK VALVE	3.000	PC	VL1166A0	BB6-AR6 L FITTING	4.000	PC	VL1167A2	GN21 3 ROTOR ARMS B-B FLOW RESTRICTOR	1.000	PC	VL1174C0	D1.2 MM CALIBRATED D1.2 MM	1.000	PC	VL1186A0	3 WAYS PLUS WASHING DISTRIBUTOR	1.000	PC	VL1190A0	PLUS WASHING SYSTEM INLET DISTRIBUTOR	1.000	PC	VL1214A0	BAYONET - 6mm BARBED NRV VALVE	1.000	PC	VM1605A0	CLIP TWIST LOCK DIAM. 10,2-12,7 MM	3.000	PC	VM2172A0	LOCKING CLIP FOR PUMP WITH CIRCUIT	5.000	PC	KVL1184A	2 ROTOR ARMS PLUS EU CLEANING SYSTEM KIT	<table border="1"> <thead> <tr> <th>Code</th> <th>Description</th> <th>Qty</th> <th>UOM</th> </tr> </thead> <tbody> <tr> <td>0H2354A1</td> <td>XEVC-XEVL PLUS WASHING CIRCUIT PLAT</td> <td>1.000</td> <td>PC</td> </tr> <tr> <td>EL1440A0</td> <td>WATER SELF CLEANING VALVE</td> <td>4.000</td> <td>PC</td> </tr> <tr> <td>GN1526A0</td> <td>INT. D.=6.9 TH=1.8 O-RIN</td> <td>9.000</td> <td>PC</td> </tr> <tr> <td>RC1018A0</td> <td>ZINC PLATED D12 ELASTIC CLAMP</td> <td>3.000</td> <td>PC</td> </tr> <tr> <td>RC1019A0</td> <td>D=10 ELASTIC CLAMP</td> <td>15.000</td> <td>PC</td> </tr> <tr> <td>RC1130A0</td> <td>130x2,6 CLAM</td> <td>1.000</td> <td>PC</td> </tr> <tr> <td>RC1131A0</td> <td>200x2,6 BLACK CLAMP</td> <td>3.000</td> <td>PC</td> </tr> </tbody> </table>	Code	Description	Qty	UOM	0H2354A1	XEVC-XEVL PLUS WASHING CIRCUIT PLAT	1.000	PC	EL1440A0	WATER SELF CLEANING VALVE	4.000	PC	GN1526A0	INT. D.=6.9 TH=1.8 O-RIN	9.000	PC	RC1018A0	ZINC PLATED D12 ELASTIC CLAMP	3.000	PC	RC1019A0	D=10 ELASTIC CLAMP	15.000	PC	RC1130A0	130x2,6 CLAM	1.000	PC	RC1131A0	200x2,6 BLACK CLAMP	3.000	PC
			Code	Description	Qty	UOM																																																																																		
VL1102A1	DETERGENT LINE FILTER + BARBED VNR 6 MM	1.000	PC																																																																																					
VL1127A1	6mm BARBED T-SHAPED FITTING	2.000	PC																																																																																					
VL1128A1	D6 BARBED CHECK VALVE	3.000	PC																																																																																					
VL1166A0	BB6-AR6 L FITTING	4.000	PC																																																																																					
VL1167A2	GN21 3 ROTOR ARMS B-B FLOW RESTRICTOR	1.000	PC																																																																																					
VL1174C0	D1.2 MM CALIBRATED D1.2 MM	1.000	PC																																																																																					
VL1186A0	3 WAYS PLUS WASHING DISTRIBUTOR	1.000	PC																																																																																					
VL1190A0	PLUS WASHING SYSTEM INLET DISTRIBUTOR	1.000	PC																																																																																					
VL1214A0	BAYONET - 6mm BARBED NRV VALVE	1.000	PC																																																																																					
VM1605A0	CLIP TWIST LOCK DIAM. 10,2-12,7 MM	3.000	PC																																																																																					
VM2172A0	LOCKING CLIP FOR PUMP WITH CIRCUIT	5.000	PC																																																																																					
Code	Description	Qty	UOM																																																																																					
0H2354A1	XEVC-XEVL PLUS WASHING CIRCUIT PLAT	1.000	PC																																																																																					
EL1440A0	WATER SELF CLEANING VALVE	4.000	PC																																																																																					
GN1526A0	INT. D.=6.9 TH=1.8 O-RIN	9.000	PC																																																																																					
RC1018A0	ZINC PLATED D12 ELASTIC CLAMP	3.000	PC																																																																																					
RC1019A0	D=10 ELASTIC CLAMP	15.000	PC																																																																																					
RC1130A0	130x2,6 CLAM	1.000	PC																																																																																					
RC1131A0	200x2,6 BLACK CLAMP	3.000	PC																																																																																					

COMPONENT			SPARE PART																																																																							
Code	Description	Image	Code	Description	Kit components																																																																					
VL1019A	VIBRATION DETERGENT PUMP		KVL1184A	2 ROTOR ARMS PLUS EU CLEANING SYSTEM KIT	<table border="1"> <thead> <tr> <th>Code</th> <th>Description</th> <th>Qty</th> <th>UOM</th> </tr> </thead> <tbody> <tr> <td>RC1242A0</td> <td>D=10 CLOSED CAP</td> <td>2.000</td> <td>PC</td> </tr> <tr> <td>RC1356A0</td> <td>"STRAIGHT THREADED FEMALE END 8x1/4" BS</td> <td>1.000</td> <td>PC</td> </tr> <tr> <td>TB2821A0</td> <td>EPDM 6X10 L=40MM PIPE</td> <td>6.000</td> <td>PC</td> </tr> <tr> <td>TB2994A0</td> <td>HOOD DETERGENT PIPE</td> <td>1.000</td> <td>PC</td> </tr> <tr> <td>TB3004A0</td> <td>TB2820A L=550mm EPDM BLACK PIPE</td> <td>2.000</td> <td>PC</td> </tr> <tr> <td>TB3005B0</td> <td>TB3132A L=550mm EPDM WHITE-BLUE PIPE</td> <td>1.000</td> <td>PC</td> </tr> <tr> <td>TB3440A0</td> <td>TB3132A L=1050mm EPDM WHITE-BLUE PIPE</td> <td>1.000</td> <td>PC</td> </tr> <tr> <td>VL1019A0</td> <td>VIBRATION DETERGENT PUMP</td> <td>1.000</td> <td>PC</td> </tr> <tr> <td>VL1047A1</td> <td>D6 PIPE HOLDER - D8 J.G. TERMINAL</td> <td>1.000</td> <td>PC</td> </tr> <tr> <td>VL1065A1</td> <td>1/4 MALE N.O. PRESSURE SWITCH</td> <td>1.000</td> <td>PC</td> </tr> <tr> <td>VL1102A1</td> <td>DETERGENT LINE FILTER + BARBED VNR 6 MM</td> <td>1.000</td> <td>PC</td> </tr> <tr> <td>VL1128A1</td> <td>D6 BARBED CHECK VALVE</td> <td>2.000</td> <td>PC</td> </tr> <tr> <td>VL1141A1</td> <td>BB6-BB6 STRAIGHT CONNECTION</td> <td>1.000</td> <td>PC</td> </tr> <tr> <td>VL1166A0</td> <td>BB6-AR6 L FITTING</td> <td>4.000</td> <td>PC</td> </tr> <tr> <td>VL1174C0</td> <td>D1.2 MM CALIBRATED D1.2 MM</td> <td>1.000</td> <td>PC</td> </tr> <tr> <td>VL1186A0</td> <td>3 WAYS PLUS WASHING DISTRIBUTOR</td> <td>1.000</td> <td>PC</td> </tr> </tbody> </table>	Code	Description	Qty	UOM	RC1242A0	D=10 CLOSED CAP	2.000	PC	RC1356A0	"STRAIGHT THREADED FEMALE END 8x1/4" BS	1.000	PC	TB2821A0	EPDM 6X10 L=40MM PIPE	6.000	PC	TB2994A0	HOOD DETERGENT PIPE	1.000	PC	TB3004A0	TB2820A L=550mm EPDM BLACK PIPE	2.000	PC	TB3005B0	TB3132A L=550mm EPDM WHITE-BLUE PIPE	1.000	PC	TB3440A0	TB3132A L=1050mm EPDM WHITE-BLUE PIPE	1.000	PC	VL1019A0	VIBRATION DETERGENT PUMP	1.000	PC	VL1047A1	D6 PIPE HOLDER - D8 J.G. TERMINAL	1.000	PC	VL1065A1	1/4 MALE N.O. PRESSURE SWITCH	1.000	PC	VL1102A1	DETERGENT LINE FILTER + BARBED VNR 6 MM	1.000	PC	VL1128A1	D6 BARBED CHECK VALVE	2.000	PC	VL1141A1	BB6-BB6 STRAIGHT CONNECTION	1.000	PC	VL1166A0	BB6-AR6 L FITTING	4.000	PC	VL1174C0	D1.2 MM CALIBRATED D1.2 MM	1.000	PC	VL1186A0	3 WAYS PLUS WASHING DISTRIBUTOR	1.000	PC	
Code	Description	Qty	UOM																																																																							
RC1242A0	D=10 CLOSED CAP	2.000	PC																																																																							
RC1356A0	"STRAIGHT THREADED FEMALE END 8x1/4" BS	1.000	PC																																																																							
TB2821A0	EPDM 6X10 L=40MM PIPE	6.000	PC																																																																							
TB2994A0	HOOD DETERGENT PIPE	1.000	PC																																																																							
TB3004A0	TB2820A L=550mm EPDM BLACK PIPE	2.000	PC																																																																							
TB3005B0	TB3132A L=550mm EPDM WHITE-BLUE PIPE	1.000	PC																																																																							
TB3440A0	TB3132A L=1050mm EPDM WHITE-BLUE PIPE	1.000	PC																																																																							
VL1019A0	VIBRATION DETERGENT PUMP	1.000	PC																																																																							
VL1047A1	D6 PIPE HOLDER - D8 J.G. TERMINAL	1.000	PC																																																																							
VL1065A1	1/4 MALE N.O. PRESSURE SWITCH	1.000	PC																																																																							
VL1102A1	DETERGENT LINE FILTER + BARBED VNR 6 MM	1.000	PC																																																																							
VL1128A1	D6 BARBED CHECK VALVE	2.000	PC																																																																							
VL1141A1	BB6-BB6 STRAIGHT CONNECTION	1.000	PC																																																																							
VL1166A0	BB6-AR6 L FITTING	4.000	PC																																																																							
VL1174C0	D1.2 MM CALIBRATED D1.2 MM	1.000	PC																																																																							
VL1186A0	3 WAYS PLUS WASHING DISTRIBUTOR	1.000	PC																																																																							



COMPONENT			SPARE PART																																																											
Code	Description	Image	Code	Description	Kit components																																																									
VL1019A	VIBRATION DETERGENT PUMP		KVL1184A	2 ROTOR ARMS PLUS EU CLEANING SYSTEM KIT	<table border="1"> <thead> <tr> <th>Code</th> <th>Description</th> <th>Qty</th> <th>UOM</th> </tr> </thead> <tbody> <tr> <td>VL1190A0</td> <td>PLUS WASHING SYSTEM INLET DISTRIBUTOR</td> <td>1.000</td> <td>PC</td> </tr> <tr> <td>VL1214A0</td> <td>BAYONET - 6mm BARBED NRV VALVE</td> <td>1.000</td> <td>PC</td> </tr> <tr> <td>VM1605A0</td> <td>CLIP TWIST LOCK DIAM. 10,2-12,7 MM</td> <td>3.000</td> <td>PC</td> </tr> <tr> <td>VM2172A0</td> <td>LOCKING CLIP FOR PUMP WITH CIRCUIT</td> <td>5.000</td> <td>PC</td> </tr> </tbody> </table>	Code	Description	Qty	UOM	VL1190A0	PLUS WASHING SYSTEM INLET DISTRIBUTOR	1.000	PC	VL1214A0	BAYONET - 6mm BARBED NRV VALVE	1.000	PC	VM1605A0	CLIP TWIST LOCK DIAM. 10,2-12,7 MM	3.000	PC	VM2172A0	LOCKING CLIP FOR PUMP WITH CIRCUIT	5.000	PC																																					
			Code	Description	Qty	UOM																																																								
VL1190A0	PLUS WASHING SYSTEM INLET DISTRIBUTOR	1.000	PC																																																											
VL1214A0	BAYONET - 6mm BARBED NRV VALVE	1.000	PC																																																											
VM1605A0	CLIP TWIST LOCK DIAM. 10,2-12,7 MM	3.000	PC																																																											
VM2172A0	LOCKING CLIP FOR PUMP WITH CIRCUIT	5.000	PC																																																											
KVL1183A	1 ROTOR ARM PLUS CLEANING SYSTEM KIT	<table border="1"> <thead> <tr> <th>Code</th> <th>Description</th> <th>Qty</th> <th>UOM</th> </tr> </thead> <tbody> <tr> <td>0H2354A1</td> <td>XEVC-XEVL PLUS WASHING CIRCUIT PLAT</td> <td>1.000</td> <td>PC</td> </tr> <tr> <td>EL1440A0</td> <td>WATER SELF CLEANING VALVE</td> <td>3.000</td> <td>PC</td> </tr> <tr> <td>GN1526A0</td> <td>INT. D.=6.9 TH=1.8 O-RIN</td> <td>7.000</td> <td>PC</td> </tr> <tr> <td>RC1018A0</td> <td>ZINC PLATED D12 ELASTIC CLAMP</td> <td>2.000</td> <td>PC</td> </tr> <tr> <td>RC1019A0</td> <td>D=10 ELASTIC CLAMP</td> <td>14.000</td> <td>PC</td> </tr> <tr> <td>RC1130A0</td> <td>130x2.6 CLAM</td> <td>1.000</td> <td>PC</td> </tr> <tr> <td>RC1131A0</td> <td>200x2.6 BLACK CLAMP</td> <td>2.000</td> <td>PC</td> </tr> <tr> <td>RC1242A0</td> <td>D=10 CLOSED CAP</td> <td>2.000</td> <td>PC</td> </tr> <tr> <td>RC1356A0</td> <td>"STRAIGHT THREADED FEMALE END 8x1/4" BS</td> <td>1.000</td> <td>PC</td> </tr> <tr> <td>TB2821A0</td> <td>EPDM 6X10 L=40MM PIPE</td> <td>6.000</td> <td>PC</td> </tr> <tr> <td>TB3004A0</td> <td>TB2820A L=550mm EPDM BLACK PIPE</td> <td>1.000</td> <td>PC</td> </tr> <tr> <td>TB3005B0</td> <td>TB3132A L=550mm EPDM WHITE-BLUE PIPE</td> <td>1.000</td> <td>PC</td> </tr> <tr> <td>TB3225B0</td> <td>TB2820A-TAN K-WASHYNG SYS CONNECTION</td> <td>1.000</td> <td>PC</td> </tr> <tr> <td>TB3252A0</td> <td>TB3252A0</td> <td>1.000</td> <td>PC</td> </tr> </tbody> </table>	Code	Description	Qty	UOM	0H2354A1	XEVC-XEVL PLUS WASHING CIRCUIT PLAT	1.000	PC	EL1440A0	WATER SELF CLEANING VALVE	3.000	PC	GN1526A0	INT. D.=6.9 TH=1.8 O-RIN	7.000	PC	RC1018A0	ZINC PLATED D12 ELASTIC CLAMP	2.000	PC	RC1019A0	D=10 ELASTIC CLAMP	14.000	PC	RC1130A0	130x2.6 CLAM	1.000	PC	RC1131A0	200x2.6 BLACK CLAMP	2.000	PC	RC1242A0	D=10 CLOSED CAP	2.000	PC	RC1356A0	"STRAIGHT THREADED FEMALE END 8x1/4" BS	1.000	PC	TB2821A0	EPDM 6X10 L=40MM PIPE	6.000	PC	TB3004A0	TB2820A L=550mm EPDM BLACK PIPE	1.000	PC	TB3005B0	TB3132A L=550mm EPDM WHITE-BLUE PIPE	1.000	PC	TB3225B0	TB2820A-TAN K-WASHYNG SYS CONNECTION	1.000	PC	TB3252A0	TB3252A0	1.000	PC
Code	Description	Qty	UOM																																																											
0H2354A1	XEVC-XEVL PLUS WASHING CIRCUIT PLAT	1.000	PC																																																											
EL1440A0	WATER SELF CLEANING VALVE	3.000	PC																																																											
GN1526A0	INT. D.=6.9 TH=1.8 O-RIN	7.000	PC																																																											
RC1018A0	ZINC PLATED D12 ELASTIC CLAMP	2.000	PC																																																											
RC1019A0	D=10 ELASTIC CLAMP	14.000	PC																																																											
RC1130A0	130x2.6 CLAM	1.000	PC																																																											
RC1131A0	200x2.6 BLACK CLAMP	2.000	PC																																																											
RC1242A0	D=10 CLOSED CAP	2.000	PC																																																											
RC1356A0	"STRAIGHT THREADED FEMALE END 8x1/4" BS	1.000	PC																																																											
TB2821A0	EPDM 6X10 L=40MM PIPE	6.000	PC																																																											
TB3004A0	TB2820A L=550mm EPDM BLACK PIPE	1.000	PC																																																											
TB3005B0	TB3132A L=550mm EPDM WHITE-BLUE PIPE	1.000	PC																																																											
TB3225B0	TB2820A-TAN K-WASHYNG SYS CONNECTION	1.000	PC																																																											
TB3252A0	TB3252A0	1.000	PC																																																											



COMPONENT			SPARE PART																																																																																					
Code	Description	Image	Code	Description	Kit components																																																																																			
VL1019A	VIBRATION DETERGENT PUMP		KVL1183A	1 ROTOR ARM PLUS CLEANING SYSTEM KIT	<table border="1"> <thead> <tr> <th>Code</th> <th>Description</th> <th>Qty</th> <th>UOM</th> </tr> </thead> <tbody> <tr> <td>VL1019A0</td> <td>VIBRATION DETERGENT PUMP</td> <td>1.000</td> <td>PC</td> </tr> <tr> <td>VL1047A1</td> <td>D6 PIPE HOLDER - D8 J.G. TERMINAL</td> <td>1.000</td> <td>PC</td> </tr> <tr> <td>VL1065A1</td> <td>1/4 MALE N.O. PRESSURE SWITCH</td> <td>1.000</td> <td>PC</td> </tr> <tr> <td>VL1102A1</td> <td>DETERGENT LINE FILTER + BARBED VNR 6 MM</td> <td>1.000</td> <td>PC</td> </tr> <tr> <td>VL1128A1</td> <td>D6 BARBED CHECK VALVE</td> <td>2.000</td> <td>PC</td> </tr> <tr> <td>VL1166A0</td> <td>BB6-AR6 L FITTING</td> <td>3.000</td> <td>PC</td> </tr> <tr> <td>VL1174C0</td> <td>D1.2 MM CALIBRATED D1.2 MM</td> <td>1.000</td> <td>PC</td> </tr> <tr> <td>VL1185A0</td> <td>2 WAYS PLUS WASHING DISTRIBUTOR</td> <td>1.000</td> <td>PC</td> </tr> <tr> <td>VL1190A0</td> <td>PLUS WASHING SYSTEM INLET DISTRIBUTOR</td> <td>1.000</td> <td>PC</td> </tr> <tr> <td>VL1214A0</td> <td>BAYONET - 6mm BARBED NRV VALVE</td> <td>1.000</td> <td>PC</td> </tr> <tr> <td>VM1605A0</td> <td>CLIP TWIST LOCK DIAM. 10,2-12,7 MM</td> <td>3.000</td> <td>PC</td> </tr> <tr> <td>VM2172A0</td> <td>LOCKING CLIP FOR PUMP WITH CIRCUIT</td> <td>4.000</td> <td>PC</td> </tr> </tbody> </table>	Code	Description	Qty	UOM	VL1019A0	VIBRATION DETERGENT PUMP	1.000	PC	VL1047A1	D6 PIPE HOLDER - D8 J.G. TERMINAL	1.000	PC	VL1065A1	1/4 MALE N.O. PRESSURE SWITCH	1.000	PC	VL1102A1	DETERGENT LINE FILTER + BARBED VNR 6 MM	1.000	PC	VL1128A1	D6 BARBED CHECK VALVE	2.000	PC	VL1166A0	BB6-AR6 L FITTING	3.000	PC	VL1174C0	D1.2 MM CALIBRATED D1.2 MM	1.000	PC	VL1185A0	2 WAYS PLUS WASHING DISTRIBUTOR	1.000	PC	VL1190A0	PLUS WASHING SYSTEM INLET DISTRIBUTOR	1.000	PC	VL1214A0	BAYONET - 6mm BARBED NRV VALVE	1.000	PC	VM1605A0	CLIP TWIST LOCK DIAM. 10,2-12,7 MM	3.000	PC	VM2172A0	LOCKING CLIP FOR PUMP WITH CIRCUIT	4.000	PC	KVL1182A	ONE 1ROT CLEANING SYSTEM KIT (0311 EXC.)	<table border="1"> <thead> <tr> <th>Code</th> <th>Description</th> <th>Qty</th> <th>UOM</th> </tr> </thead> <tbody> <tr> <td>0H2202A1</td> <td>ONE WASHING WITH STEAM VALVE SUPPORT</td> <td>1.000</td> <td>PC</td> </tr> <tr> <td>EL1440A0</td> <td>WATER SELF CLEANING VALVE</td> <td>1.000</td> <td>PC</td> </tr> <tr> <td>GN1526A0</td> <td>INT. D.=6.9 TH=1.8 O-RIN</td> <td>3.000</td> <td>PC</td> </tr> <tr> <td>RC1018A0</td> <td>ZINC PLATED D12 ELASTIC CLAMP</td> <td>1.000</td> <td>PC</td> </tr> <tr> <td>RC1019A0</td> <td>D=10 ELASTIC CLAMP</td> <td>14.000</td> <td>PC</td> </tr> <tr> <td>RC1130A0</td> <td>130x2,6 CLAM</td> <td>2.000</td> <td>PC</td> </tr> </tbody> </table>	Code	Description	Qty	UOM	0H2202A1	ONE WASHING WITH STEAM VALVE SUPPORT	1.000	PC	EL1440A0	WATER SELF CLEANING VALVE	1.000	PC	GN1526A0	INT. D.=6.9 TH=1.8 O-RIN	3.000	PC	RC1018A0	ZINC PLATED D12 ELASTIC CLAMP	1.000	PC	RC1019A0	D=10 ELASTIC CLAMP	14.000	PC	RC1130A0	130x2,6 CLAM	2.000	PC
			Code	Description	Qty	UOM																																																																																		
VL1019A0	VIBRATION DETERGENT PUMP	1.000	PC																																																																																					
VL1047A1	D6 PIPE HOLDER - D8 J.G. TERMINAL	1.000	PC																																																																																					
VL1065A1	1/4 MALE N.O. PRESSURE SWITCH	1.000	PC																																																																																					
VL1102A1	DETERGENT LINE FILTER + BARBED VNR 6 MM	1.000	PC																																																																																					
VL1128A1	D6 BARBED CHECK VALVE	2.000	PC																																																																																					
VL1166A0	BB6-AR6 L FITTING	3.000	PC																																																																																					
VL1174C0	D1.2 MM CALIBRATED D1.2 MM	1.000	PC																																																																																					
VL1185A0	2 WAYS PLUS WASHING DISTRIBUTOR	1.000	PC																																																																																					
VL1190A0	PLUS WASHING SYSTEM INLET DISTRIBUTOR	1.000	PC																																																																																					
VL1214A0	BAYONET - 6mm BARBED NRV VALVE	1.000	PC																																																																																					
VM1605A0	CLIP TWIST LOCK DIAM. 10,2-12,7 MM	3.000	PC																																																																																					
VM2172A0	LOCKING CLIP FOR PUMP WITH CIRCUIT	4.000	PC																																																																																					
Code	Description	Qty	UOM																																																																																					
0H2202A1	ONE WASHING WITH STEAM VALVE SUPPORT	1.000	PC																																																																																					
EL1440A0	WATER SELF CLEANING VALVE	1.000	PC																																																																																					
GN1526A0	INT. D.=6.9 TH=1.8 O-RIN	3.000	PC																																																																																					
RC1018A0	ZINC PLATED D12 ELASTIC CLAMP	1.000	PC																																																																																					
RC1019A0	D=10 ELASTIC CLAMP	14.000	PC																																																																																					
RC1130A0	130x2,6 CLAM	2.000	PC																																																																																					



COMPONENT			SPARE PART																																																																							
Code	Description	Image	Code	Description	Kit components																																																																					
VL1019A	VIBRATION DETERGENT PUMP		KVL1182A	ONE 1ROT CLEANING SYSTEM KIT (0311 EXC.)	<table border="1"> <thead> <tr> <th>Code</th> <th>Description</th> <th>Qty</th> <th>UOM</th> </tr> </thead> <tbody> <tr> <td>RC1242A0</td> <td>D=10 CLOSED CAP</td> <td>2.000</td> <td>PC</td> </tr> <tr> <td>TB2821A0</td> <td>EPDM 6X10 L=40MM PIPE</td> <td>6.000</td> <td>PC</td> </tr> <tr> <td>TB3004A0</td> <td>TB2820A L=550mm EPDM BLACK PIPE</td> <td>1.000</td> <td>PC</td> </tr> <tr> <td>TB3009B0</td> <td>TB3132A-ONE OVEN WASHING INLET</td> <td>1.000</td> <td>PC</td> </tr> <tr> <td>TB3225B0</td> <td>TB2820A-TAN K-WASHYNG SYS CONNECTION</td> <td>1.000</td> <td>PC</td> </tr> <tr> <td>VI1220A1</td> <td>4,2x12 TCB SELF-TAPPIN G SCREW</td> <td>1.000</td> <td>PC</td> </tr> <tr> <td>VL1019A0</td> <td>VIBRATION DETERGENT PUMP</td> <td>1.000</td> <td>PC</td> </tr> <tr> <td>VL1047A1</td> <td>D6 PIPE HOLDER - D8 J.G. TERMINAL</td> <td>1.000</td> <td>PC</td> </tr> <tr> <td>VL1054B0</td> <td>ONE WASHING SYS INLET DISTRIBUTOR</td> <td>1.000</td> <td>PC</td> </tr> <tr> <td>VL1102A1</td> <td>DETERGENT LINE FILTER + BARBED VNR 6 MM</td> <td>1.000</td> <td>PC</td> </tr> <tr> <td>VL1128A1</td> <td>D6 BARBED CHECK VALVE</td> <td>2.000</td> <td>PC</td> </tr> <tr> <td>VL1166A0</td> <td>BB6-AR6 L FITTING</td> <td>1.000</td> <td>PC</td> </tr> <tr> <td>VL1174C0</td> <td>D1.2 MM CALIBRATED D1.2 MM</td> <td>1.000</td> <td>PC</td> </tr> <tr> <td>VL1191A0</td> <td>ONE WASHING DISTRIBUTOR OUTLETS KIT</td> <td>1.000</td> <td>PC</td> </tr> <tr> <td>VL1214A0</td> <td>BAYONET - 6mm BARBED NRV VALVE</td> <td>1.000</td> <td>PC</td> </tr> <tr> <td>VM2172A0</td> <td>LOCKING CLIP FOR PUMP WITH CIRCUIT</td> <td>2.000</td> <td>PC</td> </tr> </tbody> </table>	Code	Description	Qty	UOM	RC1242A0	D=10 CLOSED CAP	2.000	PC	TB2821A0	EPDM 6X10 L=40MM PIPE	6.000	PC	TB3004A0	TB2820A L=550mm EPDM BLACK PIPE	1.000	PC	TB3009B0	TB3132A-ONE OVEN WASHING INLET	1.000	PC	TB3225B0	TB2820A-TAN K-WASHYNG SYS CONNECTION	1.000	PC	VI1220A1	4,2x12 TCB SELF-TAPPIN G SCREW	1.000	PC	VL1019A0	VIBRATION DETERGENT PUMP	1.000	PC	VL1047A1	D6 PIPE HOLDER - D8 J.G. TERMINAL	1.000	PC	VL1054B0	ONE WASHING SYS INLET DISTRIBUTOR	1.000	PC	VL1102A1	DETERGENT LINE FILTER + BARBED VNR 6 MM	1.000	PC	VL1128A1	D6 BARBED CHECK VALVE	2.000	PC	VL1166A0	BB6-AR6 L FITTING	1.000	PC	VL1174C0	D1.2 MM CALIBRATED D1.2 MM	1.000	PC	VL1191A0	ONE WASHING DISTRIBUTOR OUTLETS KIT	1.000	PC	VL1214A0	BAYONET - 6mm BARBED NRV VALVE	1.000	PC	VM2172A0	LOCKING CLIP FOR PUMP WITH CIRCUIT	2.000	PC	
Code	Description	Qty	UOM																																																																							
RC1242A0	D=10 CLOSED CAP	2.000	PC																																																																							
TB2821A0	EPDM 6X10 L=40MM PIPE	6.000	PC																																																																							
TB3004A0	TB2820A L=550mm EPDM BLACK PIPE	1.000	PC																																																																							
TB3009B0	TB3132A-ONE OVEN WASHING INLET	1.000	PC																																																																							
TB3225B0	TB2820A-TAN K-WASHYNG SYS CONNECTION	1.000	PC																																																																							
VI1220A1	4,2x12 TCB SELF-TAPPIN G SCREW	1.000	PC																																																																							
VL1019A0	VIBRATION DETERGENT PUMP	1.000	PC																																																																							
VL1047A1	D6 PIPE HOLDER - D8 J.G. TERMINAL	1.000	PC																																																																							
VL1054B0	ONE WASHING SYS INLET DISTRIBUTOR	1.000	PC																																																																							
VL1102A1	DETERGENT LINE FILTER + BARBED VNR 6 MM	1.000	PC																																																																							
VL1128A1	D6 BARBED CHECK VALVE	2.000	PC																																																																							
VL1166A0	BB6-AR6 L FITTING	1.000	PC																																																																							
VL1174C0	D1.2 MM CALIBRATED D1.2 MM	1.000	PC																																																																							
VL1191A0	ONE WASHING DISTRIBUTOR OUTLETS KIT	1.000	PC																																																																							
VL1214A0	BAYONET - 6mm BARBED NRV VALVE	1.000	PC																																																																							
VM2172A0	LOCKING CLIP FOR PUMP WITH CIRCUIT	2.000	PC																																																																							



COMPONENT			SPARE PART																																																																																																					
Code	Description	Image	Code	Description	Kit components																																																																																																			
VL1019A	VIBRATION DETERGENT PUMP		KVL0684A	>12/2019 2-3ROTOR ARM PLUS WASH PUMP KIT	<table border="1"> <thead> <tr> <th>Code</th> <th>Description</th> <th>Qty</th> <th>UOM</th> </tr> </thead> <tbody> <tr> <td>GN1526A0</td> <td>INT. D.=6.9 TH=1.8 O-RIN</td> <td>3.000</td> <td>PC</td> </tr> <tr> <td>RC1019A0</td> <td>D=10 ELASTIC CLAMP</td> <td>4.000</td> <td>PC</td> </tr> <tr> <td>RC1130A0</td> <td>130x2.6 CLAM</td> <td>1.000</td> <td>PC</td> </tr> <tr> <td>RC1131A0</td> <td>200x2.6 BLACK CLAMP</td> <td>3.000</td> <td>PC</td> </tr> <tr> <td>RC1242A0</td> <td>D=10 CLOSED CAP</td> <td>2.000</td> <td>PC</td> </tr> <tr> <td>TB2821A0</td> <td>EPDM 6X10 L=40MM PIPE</td> <td>3.000</td> <td>PC</td> </tr> <tr> <td>VL1019A0</td> <td>VIBRATION DETERGENT PUMP</td> <td>1.000</td> <td>PC</td> </tr> <tr> <td>VL1128A1</td> <td>D6 BARBED CHECK VALVE</td> <td>1.000</td> <td>PC</td> </tr> <tr> <td>VL1174C0</td> <td>D1.2 MM CALIBRATED D1.2 MM</td> <td>1.000</td> <td>PC</td> </tr> <tr> <td>VL1186A0</td> <td>3 WAYS PLUS WASHING DISTRIBUTOR</td> <td>1.000</td> <td>PC</td> </tr> <tr> <td>VL1190A0</td> <td>PLUS WASHING SYSTEM INLET DISTRIBUTOR</td> <td>1.000</td> <td>PC</td> </tr> <tr> <td>VM2172A0</td> <td>LOCKING CLIP FOR PUMP WITH CIRCUIT</td> <td>1.000</td> <td>PC</td> </tr> </tbody> </table>	Code	Description	Qty	UOM	GN1526A0	INT. D.=6.9 TH=1.8 O-RIN	3.000	PC	RC1019A0	D=10 ELASTIC CLAMP	4.000	PC	RC1130A0	130x2.6 CLAM	1.000	PC	RC1131A0	200x2.6 BLACK CLAMP	3.000	PC	RC1242A0	D=10 CLOSED CAP	2.000	PC	TB2821A0	EPDM 6X10 L=40MM PIPE	3.000	PC	VL1019A0	VIBRATION DETERGENT PUMP	1.000	PC	VL1128A1	D6 BARBED CHECK VALVE	1.000	PC	VL1174C0	D1.2 MM CALIBRATED D1.2 MM	1.000	PC	VL1186A0	3 WAYS PLUS WASHING DISTRIBUTOR	1.000	PC	VL1190A0	PLUS WASHING SYSTEM INLET DISTRIBUTOR	1.000	PC	VM2172A0	LOCKING CLIP FOR PUMP WITH CIRCUIT	1.000	PC	KVL0683A	>12/2019 1 ROTOR ARM PLUS WASH PUMP KIT	<table border="1"> <thead> <tr> <th>Code</th> <th>Description</th> <th>Qty</th> <th>UOM</th> </tr> </thead> <tbody> <tr> <td>GN1526A0</td> <td>INT. D.=6.9 TH=1.8 O-RIN</td> <td>2.000</td> <td>PC</td> </tr> <tr> <td>RC1019A0</td> <td>D=10 ELASTIC CLAMP</td> <td>4.000</td> <td>PC</td> </tr> <tr> <td>RC1130A0</td> <td>130x2.6 CLAM</td> <td>1.000</td> <td>PC</td> </tr> <tr> <td>RC1131A0</td> <td>200x2.6 BLACK CLAMP</td> <td>2.000</td> <td>PC</td> </tr> <tr> <td>RC1242A0</td> <td>D=10 CLOSED CAP</td> <td>2.000</td> <td>PC</td> </tr> <tr> <td>TB2821A0</td> <td>EPDM 6X10 L=40MM PIPE</td> <td>3.000</td> <td>PC</td> </tr> <tr> <td>VL1019A0</td> <td>VIBRATION DETERGENT PUMP</td> <td>1.000</td> <td>PC</td> </tr> <tr> <td>VL1128A1</td> <td>D6 BARBED CHECK VALVE</td> <td>1.000</td> <td>PC</td> </tr> <tr> <td>VL1174C0</td> <td>D1.2 MM CALIBRATED D1.2 MM</td> <td>1.000</td> <td>PC</td> </tr> <tr> <td>VL1185A0</td> <td>2 WAYS PLUS WASHING DISTRIBUTOR</td> <td>1.000</td> <td>PC</td> </tr> </tbody> </table>	Code	Description	Qty	UOM	GN1526A0	INT. D.=6.9 TH=1.8 O-RIN	2.000	PC	RC1019A0	D=10 ELASTIC CLAMP	4.000	PC	RC1130A0	130x2.6 CLAM	1.000	PC	RC1131A0	200x2.6 BLACK CLAMP	2.000	PC	RC1242A0	D=10 CLOSED CAP	2.000	PC	TB2821A0	EPDM 6X10 L=40MM PIPE	3.000	PC	VL1019A0	VIBRATION DETERGENT PUMP	1.000	PC	VL1128A1	D6 BARBED CHECK VALVE	1.000	PC	VL1174C0	D1.2 MM CALIBRATED D1.2 MM	1.000	PC	VL1185A0	2 WAYS PLUS WASHING DISTRIBUTOR	1.000	PC
			Code	Description	Qty	UOM																																																																																																		
GN1526A0	INT. D.=6.9 TH=1.8 O-RIN	3.000	PC																																																																																																					
RC1019A0	D=10 ELASTIC CLAMP	4.000	PC																																																																																																					
RC1130A0	130x2.6 CLAM	1.000	PC																																																																																																					
RC1131A0	200x2.6 BLACK CLAMP	3.000	PC																																																																																																					
RC1242A0	D=10 CLOSED CAP	2.000	PC																																																																																																					
TB2821A0	EPDM 6X10 L=40MM PIPE	3.000	PC																																																																																																					
VL1019A0	VIBRATION DETERGENT PUMP	1.000	PC																																																																																																					
VL1128A1	D6 BARBED CHECK VALVE	1.000	PC																																																																																																					
VL1174C0	D1.2 MM CALIBRATED D1.2 MM	1.000	PC																																																																																																					
VL1186A0	3 WAYS PLUS WASHING DISTRIBUTOR	1.000	PC																																																																																																					
VL1190A0	PLUS WASHING SYSTEM INLET DISTRIBUTOR	1.000	PC																																																																																																					
VM2172A0	LOCKING CLIP FOR PUMP WITH CIRCUIT	1.000	PC																																																																																																					
Code	Description	Qty	UOM																																																																																																					
GN1526A0	INT. D.=6.9 TH=1.8 O-RIN	2.000	PC																																																																																																					
RC1019A0	D=10 ELASTIC CLAMP	4.000	PC																																																																																																					
RC1130A0	130x2.6 CLAM	1.000	PC																																																																																																					
RC1131A0	200x2.6 BLACK CLAMP	2.000	PC																																																																																																					
RC1242A0	D=10 CLOSED CAP	2.000	PC																																																																																																					
TB2821A0	EPDM 6X10 L=40MM PIPE	3.000	PC																																																																																																					
VL1019A0	VIBRATION DETERGENT PUMP	1.000	PC																																																																																																					
VL1128A1	D6 BARBED CHECK VALVE	1.000	PC																																																																																																					
VL1174C0	D1.2 MM CALIBRATED D1.2 MM	1.000	PC																																																																																																					
VL1185A0	2 WAYS PLUS WASHING DISTRIBUTOR	1.000	PC																																																																																																					





COMPONENT			SPARE PART																																											
Code	Description	Image	Code	Description	Kit components																																									
VL1019A	VIBRATION DETERGENT PUMP		KVL0683A	>12/2019 1 ROTOR ARM PLUS WASH PUMP KIT	<table border="1"> <thead> <tr> <th>Code</th> <th>Description</th> <th>Qty</th> <th>UOM</th> </tr> </thead> <tbody> <tr> <td>VL1190A0</td> <td>PLUS WASHING SYSTEM INLET DISTRIBUTOR</td> <td>1.000</td> <td>PC</td> </tr> <tr> <td>VM2172A0</td> <td>LOCKING CLIP FOR PUMP WITH CIRCUIT</td> <td>1.000</td> <td>PC</td> </tr> </tbody> </table>	Code	Description	Qty	UOM	VL1190A0	PLUS WASHING SYSTEM INLET DISTRIBUTOR	1.000	PC	VM2172A0	LOCKING CLIP FOR PUMP WITH CIRCUIT	1.000	PC																													
			Code	Description	Qty	UOM																																								
			VL1190A0	PLUS WASHING SYSTEM INLET DISTRIBUTOR	1.000	PC																																								
VM2172A0	LOCKING CLIP FOR PUMP WITH CIRCUIT	1.000	PC																																											
KVL0682A	>12/2019 ONE/HOODS WASHING SYST PUMP KIT	<table border="1"> <thead> <tr> <th>Code</th> <th>Description</th> <th>Qty</th> <th>UOM</th> </tr> </thead> <tbody> <tr> <td>GN1526A0</td> <td>INT. D.=6.9 TH=1.8 O-RIN</td> <td>1.000</td> <td>PC</td> </tr> <tr> <td>RC1019A0</td> <td>D=10 ELASTIC CLAMP</td> <td>6.000</td> <td>PC</td> </tr> <tr> <td>RC1242A0</td> <td>D=10 CLOSED CAP</td> <td>2.000</td> <td>PC</td> </tr> <tr> <td>TB2821A0</td> <td>EPDM 6X10 L=40MM PIPE</td> <td>3.000</td> <td>PC</td> </tr> <tr> <td>VL1019A0</td> <td>VIBRATION DETERGENT PUMP</td> <td>1.000</td> <td>PC</td> </tr> <tr> <td>VL1054B0</td> <td>ONE WASHING SYS INLET DISTRIBUTOR</td> <td>1.000</td> <td>PC</td> </tr> <tr> <td>VL1128A1</td> <td>D6 BARBED CHECK VALVE</td> <td>1.000</td> <td>PC</td> </tr> <tr> <td>VL1174C0</td> <td>D1.2 MM CALIBRATED D1.2 MM</td> <td>1.000</td> <td>PC</td> </tr> <tr> <td>VL1191A0</td> <td>ONE WASHING DISTRIBUTOR OUTLETS KIT</td> <td>1.000</td> <td>PC</td> </tr> <tr> <td>VM2172A0</td> <td>LOCKING CLIP FOR PUMP WITH CIRCUIT</td> <td>1.000</td> <td>PC</td> </tr> </tbody> </table>	Code	Description	Qty	UOM	GN1526A0	INT. D.=6.9 TH=1.8 O-RIN	1.000	PC	RC1019A0	D=10 ELASTIC CLAMP	6.000	PC	RC1242A0	D=10 CLOSED CAP	2.000	PC	TB2821A0	EPDM 6X10 L=40MM PIPE	3.000	PC	VL1019A0	VIBRATION DETERGENT PUMP	1.000	PC	VL1054B0	ONE WASHING SYS INLET DISTRIBUTOR	1.000	PC	VL1128A1	D6 BARBED CHECK VALVE	1.000	PC	VL1174C0	D1.2 MM CALIBRATED D1.2 MM	1.000	PC	VL1191A0	ONE WASHING DISTRIBUTOR OUTLETS KIT	1.000	PC	VM2172A0	LOCKING CLIP FOR PUMP WITH CIRCUIT	1.000	PC
Code	Description	Qty	UOM																																											
GN1526A0	INT. D.=6.9 TH=1.8 O-RIN	1.000	PC																																											
RC1019A0	D=10 ELASTIC CLAMP	6.000	PC																																											
RC1242A0	D=10 CLOSED CAP	2.000	PC																																											
TB2821A0	EPDM 6X10 L=40MM PIPE	3.000	PC																																											
VL1019A0	VIBRATION DETERGENT PUMP	1.000	PC																																											
VL1054B0	ONE WASHING SYS INLET DISTRIBUTOR	1.000	PC																																											
VL1128A1	D6 BARBED CHECK VALVE	1.000	PC																																											
VL1174C0	D1.2 MM CALIBRATED D1.2 MM	1.000	PC																																											
VL1191A0	ONE WASHING DISTRIBUTOR OUTLETS KIT	1.000	PC																																											
VM2172A0	LOCKING CLIP FOR PUMP WITH CIRCUIT	1.000	PC																																											
KVL0001A	LM TOP CLEANING SYSTEM KIT	<table border="1"> <thead> <tr> <th>Code</th> <th>Description</th> <th>Qty</th> <th>UOM</th> </tr> </thead> <tbody> <tr> <td>0H1226B0</td> <td>LineMissTop WASHING SYTEM CIRCUIT COVE</td> <td>1.000</td> <td>PC</td> </tr> <tr> <td>EL1436B0</td> <td>JG D8-BARBED D6 NRV WATER SOLENOID</td> <td>1.000</td> <td>PC</td> </tr> <tr> <td>GN1312A0</td> <td>RUBBER CABLE-PASSI NG DE=26 DI=15 SP=10</td> <td>1.000</td> <td>PC</td> </tr> <tr> <td>GN1526A0</td> <td>INT. D.=6.9 TH=1.8 O-RIN</td> <td>1.000</td> <td>PC</td> </tr> <tr> <td>RC1019A0</td> <td>D=10 ELASTIC CLAMP</td> <td>5.000</td> <td>PC</td> </tr> </tbody> </table>	Code	Description	Qty	UOM	0H1226B0	LineMissTop WASHING SYTEM CIRCUIT COVE	1.000	PC	EL1436B0	JG D8-BARBED D6 NRV WATER SOLENOID	1.000	PC	GN1312A0	RUBBER CABLE-PASSI NG DE=26 DI=15 SP=10	1.000	PC	GN1526A0	INT. D.=6.9 TH=1.8 O-RIN	1.000	PC	RC1019A0	D=10 ELASTIC CLAMP	5.000	PC																				
Code	Description	Qty	UOM																																											
0H1226B0	LineMissTop WASHING SYTEM CIRCUIT COVE	1.000	PC																																											
EL1436B0	JG D8-BARBED D6 NRV WATER SOLENOID	1.000	PC																																											
GN1312A0	RUBBER CABLE-PASSI NG DE=26 DI=15 SP=10	1.000	PC																																											
GN1526A0	INT. D.=6.9 TH=1.8 O-RIN	1.000	PC																																											
RC1019A0	D=10 ELASTIC CLAMP	5.000	PC																																											





COMPONENT			SPARE PART																																																																										
Code	Description	Image	Code	Description	Kit components																																																																								
VL1019A	VIBRATION DETERGENT PUMP		KVL0001A	LM TOP CLEANING SYSTEM KIT	<table border="1"> <thead> <tr> <th>Code</th> <th>Description</th> <th>Qty</th> <th>UOM</th> </tr> </thead> <tbody> <tr> <td>RC1242A0</td> <td>D=10 CLOSED CAP</td> <td>2.000</td> <td>PC</td> </tr> <tr> <td>RC1381A0</td> <td>BIFILAR PIPE CLIP D10.7</td> <td>3.000</td> <td>PC</td> </tr> <tr> <td>TB1114A1</td> <td>TB2820A-LM TOP DETERGENT PIPE COIL ROTOR</td> <td>1.000</td> <td>PC</td> </tr> <tr> <td>TB1116A0</td> <td>TB2343A-DETE RGENT HOLD DOWN WEIGHT PIPE</td> <td>1.000</td> <td>PC</td> </tr> <tr> <td>TB2821A0</td> <td>EPDM 6X10 L=40MM PIPE</td> <td>1.000</td> <td>PC</td> </tr> <tr> <td>VI1220A1</td> <td>4,2x12 TCB SELF-TAPPIN G SCREW</td> <td>1.000</td> <td>PC</td> </tr> <tr> <td>VL1019A0</td> <td>VIBRATION DETERGENT PUMP</td> <td>1.000</td> <td>PC</td> </tr> <tr> <td>VL1047A1</td> <td>D6 PIPE HOLDER - D8 J.G. TERMINAL</td> <td>1.000</td> <td>PC</td> </tr> <tr> <td>VL1053B0</td> <td>ONE WASHING SYS EXT DISTRIBUTOR</td> <td>1.000</td> <td>PC</td> </tr> <tr> <td>VL1054B0</td> <td>ONE WASHING SYS INLET DISTRIBUTOR</td> <td>1.000</td> <td>PC</td> </tr> <tr> <td>VL1061A0</td> <td>HOLD DOWN WEIGHT+NET FILTER+NON- RET. V.</td> <td>1.000</td> <td>PC</td> </tr> <tr> <td>VL1090A0</td> <td>1LT TANK UNOX.DET&RI NSE CAP</td> <td>1.000</td> <td>PC</td> </tr> <tr> <td>VL1128A1</td> <td>D6 BARBED CHECK VALVE</td> <td>2.000</td> <td>PC</td> </tr> <tr> <td>VM1066A0</td> <td>SADDLE CLIP FOR CABLES PASSING</td> <td>3.000</td> <td>PC</td> </tr> <tr> <td>VM1088A0</td> <td>NYLON CLICK CLAMP D7.9-D9.2</td> <td>1.000</td> <td>PC</td> </tr> <tr> <td>VM1605A0</td> <td>CLIP TWIST LOCK DIAM. 10.2-12.7 MM</td> <td>1.000</td> <td>PC</td> </tr> <tr> <td>VM2172A0</td> <td>LOCKING CLIP FOR PUMP WITH CIRCUIT</td> <td>1.000</td> <td>PC</td> </tr> </tbody> </table>	Code	Description	Qty	UOM	RC1242A0	D=10 CLOSED CAP	2.000	PC	RC1381A0	BIFILAR PIPE CLIP D10.7	3.000	PC	TB1114A1	TB2820A-LM TOP DETERGENT PIPE COIL ROTOR	1.000	PC	TB1116A0	TB2343A-DETE RGENT HOLD DOWN WEIGHT PIPE	1.000	PC	TB2821A0	EPDM 6X10 L=40MM PIPE	1.000	PC	VI1220A1	4,2x12 TCB SELF-TAPPIN G SCREW	1.000	PC	VL1019A0	VIBRATION DETERGENT PUMP	1.000	PC	VL1047A1	D6 PIPE HOLDER - D8 J.G. TERMINAL	1.000	PC	VL1053B0	ONE WASHING SYS EXT DISTRIBUTOR	1.000	PC	VL1054B0	ONE WASHING SYS INLET DISTRIBUTOR	1.000	PC	VL1061A0	HOLD DOWN WEIGHT+NET FILTER+NON- RET. V.	1.000	PC	VL1090A0	1LT TANK UNOX.DET&RI NSE CAP	1.000	PC	VL1128A1	D6 BARBED CHECK VALVE	2.000	PC	VM1066A0	SADDLE CLIP FOR CABLES PASSING	3.000	PC	VM1088A0	NYLON CLICK CLAMP D7.9-D9.2	1.000	PC	VM1605A0	CLIP TWIST LOCK DIAM. 10.2-12.7 MM	1.000	PC	VM2172A0	LOCKING CLIP FOR PUMP WITH CIRCUIT	1.000	PC
					Code	Description	Qty	UOM																																																																					
RC1242A0	D=10 CLOSED CAP	2.000	PC																																																																										
RC1381A0	BIFILAR PIPE CLIP D10.7	3.000	PC																																																																										
TB1114A1	TB2820A-LM TOP DETERGENT PIPE COIL ROTOR	1.000	PC																																																																										
TB1116A0	TB2343A-DETE RGENT HOLD DOWN WEIGHT PIPE	1.000	PC																																																																										
TB2821A0	EPDM 6X10 L=40MM PIPE	1.000	PC																																																																										
VI1220A1	4,2x12 TCB SELF-TAPPIN G SCREW	1.000	PC																																																																										
VL1019A0	VIBRATION DETERGENT PUMP	1.000	PC																																																																										
VL1047A1	D6 PIPE HOLDER - D8 J.G. TERMINAL	1.000	PC																																																																										
VL1053B0	ONE WASHING SYS EXT DISTRIBUTOR	1.000	PC																																																																										
VL1054B0	ONE WASHING SYS INLET DISTRIBUTOR	1.000	PC																																																																										
VL1061A0	HOLD DOWN WEIGHT+NET FILTER+NON- RET. V.	1.000	PC																																																																										
VL1090A0	1LT TANK UNOX.DET&RI NSE CAP	1.000	PC																																																																										
VL1128A1	D6 BARBED CHECK VALVE	2.000	PC																																																																										
VM1066A0	SADDLE CLIP FOR CABLES PASSING	3.000	PC																																																																										
VM1088A0	NYLON CLICK CLAMP D7.9-D9.2	1.000	PC																																																																										
VM1605A0	CLIP TWIST LOCK DIAM. 10.2-12.7 MM	1.000	PC																																																																										
VM2172A0	LOCKING CLIP FOR PUMP WITH CIRCUIT	1.000	PC																																																																										



COMPONENT			SPARE PART																																																						
Code	Description	Image	Code	Description	Kit components																																																				
VL1128A	D6 BARBED CHECK VALVE		KVL1128A	D6 VNR BARBED VALVE KIT	<table border="1"> <thead> <tr> <th>Code</th> <th>Description</th> <th>Qty</th> <th>UOM</th> </tr> </thead> <tbody> <tr> <td>RC1019A0</td> <td>D=10 ELASTIC CLAMP</td> <td>4.000</td> <td>PC</td> </tr> <tr> <td>TB2820A0</td> <td>6X10 EPDM PIPE FOR WASHING SYSTEM</td> <td>0.080</td> <td>M</td> </tr> <tr> <td>VL1128A1</td> <td>D6 BARBED CHECK VALVE</td> <td>1.000</td> <td>PC</td> </tr> </tbody> </table>	Code	Description	Qty	UOM	RC1019A0	D=10 ELASTIC CLAMP	4.000	PC	TB2820A0	6X10 EPDM PIPE FOR WASHING SYSTEM	0.080	M	VL1128A1	D6 BARBED CHECK VALVE	1.000	PC																																				
Code	Description	Qty	UOM																																																						
RC1019A0	D=10 ELASTIC CLAMP	4.000	PC																																																						
TB2820A0	6X10 EPDM PIPE FOR WASHING SYSTEM	0.080	M																																																						
VL1128A1	D6 BARBED CHECK VALVE	1.000	PC																																																						
VL1174C	D1.2 MM CALIBRATED D1.2 M		VL1174C0	D1.2 MM CALIBRATED D1.2 M																																																					
VL1185A	2 WAYS PLUS WASHING DISTRIBUTOR		KVL1213A	US PLUS COMPACT WASHING SYSTEM KIT	<table border="1"> <thead> <tr> <th>Code</th> <th>Description</th> <th>Qty</th> <th>UOM</th> </tr> </thead> <tbody> <tr> <td>0H2428A2</td> <td>XECC PLUS WASHING CIRCUIT PLAT</td> <td>1.000</td> <td>PC</td> </tr> <tr> <td>EL1450A0</td> <td>US SELF-CLEANING WATER SOLENOID</td> <td>3.000</td> <td>PC</td> </tr> <tr> <td>GN1312A0</td> <td>RUBBER CABLE-PASSING NG DE=26 DI=15 SP=10</td> <td>1.000</td> <td>PC</td> </tr> <tr> <td>GN1526A0</td> <td>INT. D.=6.9 TH=1.8 O-RING</td> <td>7.000</td> <td>PC</td> </tr> <tr> <td>RC1018A0</td> <td>ZINC PLATED D12 ELASTIC CLAMP</td> <td>2.000</td> <td>PC</td> </tr> <tr> <td>RC1019A0</td> <td>D=10 ELASTIC CLAMP</td> <td>14.000</td> <td>PC</td> </tr> <tr> <td>RC1130A0</td> <td>130x2.6 CLAMP</td> <td>1.000</td> <td>PC</td> </tr> <tr> <td>RC1131A0</td> <td>200x2.6 BLACK CLAMP</td> <td>1.000</td> <td>PC</td> </tr> <tr> <td>RC1242A0</td> <td>D=10 CLOSED CAP</td> <td>2.000</td> <td>PC</td> </tr> <tr> <td>RC1356A0</td> <td>"STRAIGHT THREADED FEMALE END 8x1/4" BS</td> <td>1.000</td> <td>PC</td> </tr> <tr> <td>TB2821A0</td> <td>EPDM 6X10 L=40MM PIPE</td> <td>6.000</td> <td>PC</td> </tr> <tr> <td>TB3004A0</td> <td>TB2820A L=550mm EPDM BLACK PIPE</td> <td>1.000</td> <td>PC</td> </tr> </tbody> </table>	Code	Description	Qty	UOM	0H2428A2	XECC PLUS WASHING CIRCUIT PLAT	1.000	PC	EL1450A0	US SELF-CLEANING WATER SOLENOID	3.000	PC	GN1312A0	RUBBER CABLE-PASSING NG DE=26 DI=15 SP=10	1.000	PC	GN1526A0	INT. D.=6.9 TH=1.8 O-RING	7.000	PC	RC1018A0	ZINC PLATED D12 ELASTIC CLAMP	2.000	PC	RC1019A0	D=10 ELASTIC CLAMP	14.000	PC	RC1130A0	130x2.6 CLAMP	1.000	PC	RC1131A0	200x2.6 BLACK CLAMP	1.000	PC	RC1242A0	D=10 CLOSED CAP	2.000	PC	RC1356A0	"STRAIGHT THREADED FEMALE END 8x1/4" BS	1.000	PC	TB2821A0	EPDM 6X10 L=40MM PIPE	6.000	PC	TB3004A0	TB2820A L=550mm EPDM BLACK PIPE	1.000	PC
Code	Description	Qty	UOM																																																						
0H2428A2	XECC PLUS WASHING CIRCUIT PLAT	1.000	PC																																																						
EL1450A0	US SELF-CLEANING WATER SOLENOID	3.000	PC																																																						
GN1312A0	RUBBER CABLE-PASSING NG DE=26 DI=15 SP=10	1.000	PC																																																						
GN1526A0	INT. D.=6.9 TH=1.8 O-RING	7.000	PC																																																						
RC1018A0	ZINC PLATED D12 ELASTIC CLAMP	2.000	PC																																																						
RC1019A0	D=10 ELASTIC CLAMP	14.000	PC																																																						
RC1130A0	130x2.6 CLAMP	1.000	PC																																																						
RC1131A0	200x2.6 BLACK CLAMP	1.000	PC																																																						
RC1242A0	D=10 CLOSED CAP	2.000	PC																																																						
RC1356A0	"STRAIGHT THREADED FEMALE END 8x1/4" BS	1.000	PC																																																						
TB2821A0	EPDM 6X10 L=40MM PIPE	6.000	PC																																																						
TB3004A0	TB2820A L=550mm EPDM BLACK PIPE	1.000	PC																																																						



COMPONENT			SPARE PART																																																																																	
Code	Description	Image	Code	Description	Kit components																																																																															
VL1185A	2 WAYS PLUS WASHING DISTRIBUTOR		KVL1213A	US PLUS COMPACT WASHING SYSTEM KIT	<table border="1"> <thead> <tr> <th>Code</th> <th>Description</th> <th>Qty</th> <th>UOM</th> </tr> </thead> <tbody> <tr> <td>TB3005B0</td> <td>TB3132A L=550mm EPDM WHITE-BLUE PIPE</td> <td>1.000</td> <td>PC</td> </tr> <tr> <td>TB3469A0</td> <td></td> <td>1.000</td> <td>PC</td> </tr> <tr> <td>VL1019A0</td> <td>VIBRATION DETERGENT PUMP</td> <td>1.000</td> <td>PC</td> </tr> <tr> <td>VL1047A1</td> <td>D6 PIPE HOLDER - D8 J.G. TERMINAL</td> <td>1.000</td> <td>PC</td> </tr> <tr> <td>VL1054B0</td> <td>ONE WASHING SYS INLET DISTRIBUTOR</td> <td>1.000</td> <td>PC</td> </tr> <tr> <td>VL1065A1</td> <td>1/4 MALE N.O. PRESSURE SWITCH</td> <td>1.000</td> <td>PC</td> </tr> <tr> <td>VL1102A1</td> <td>DETERGENT LINE FILTER + BARBED VNR 6 MM</td> <td>1.000</td> <td>PC</td> </tr> <tr> <td>VL1128A1</td> <td>D6 BARBED CHECK VALVE</td> <td>2.000</td> <td>PC</td> </tr> <tr> <td>VL1165A0</td> <td>BAM-BB6 STRAIGHT FITTING</td> <td>1.000</td> <td>PC</td> </tr> <tr> <td>VL1166A0</td> <td>BB6-AR6 L FITTING</td> <td>3.000</td> <td>PC</td> </tr> <tr> <td>VL1174C0</td> <td>D1.2 MM CALIBRATED D1.2 MM</td> <td>1.000</td> <td>PC</td> </tr> <tr> <td>VL1185A0</td> <td>2 WAYS PLUS WASHING DISTRIBUTOR</td> <td>1.000</td> <td>PC</td> </tr> <tr> <td>VM2172A0</td> <td>LOCKING CLIP FOR PUMP WITH CIRCUIT</td> <td>6.000</td> <td>PC</td> </tr> </tbody> </table>	Code	Description	Qty	UOM	TB3005B0	TB3132A L=550mm EPDM WHITE-BLUE PIPE	1.000	PC	TB3469A0		1.000	PC	VL1019A0	VIBRATION DETERGENT PUMP	1.000	PC	VL1047A1	D6 PIPE HOLDER - D8 J.G. TERMINAL	1.000	PC	VL1054B0	ONE WASHING SYS INLET DISTRIBUTOR	1.000	PC	VL1065A1	1/4 MALE N.O. PRESSURE SWITCH	1.000	PC	VL1102A1	DETERGENT LINE FILTER + BARBED VNR 6 MM	1.000	PC	VL1128A1	D6 BARBED CHECK VALVE	2.000	PC	VL1165A0	BAM-BB6 STRAIGHT FITTING	1.000	PC	VL1166A0	BB6-AR6 L FITTING	3.000	PC	VL1174C0	D1.2 MM CALIBRATED D1.2 MM	1.000	PC	VL1185A0	2 WAYS PLUS WASHING DISTRIBUTOR	1.000	PC	VM2172A0	LOCKING CLIP FOR PUMP WITH CIRCUIT	6.000	PC	KVL1212A	EUR COMPACT PLUS CLEANING SYSTEM KIT	<table border="1"> <thead> <tr> <th>Code</th> <th>Description</th> <th>Qty</th> <th>UOM</th> </tr> </thead> <tbody> <tr> <td>0H2428A2</td> <td>XECC PLUS WASHING CIRCUIT PLAT</td> <td>1.000</td> <td>PC</td> </tr> <tr> <td>EL1440A0</td> <td>WATER SELF CLEANING VALVE</td> <td>3.000</td> <td>PC</td> </tr> <tr> <td>GN1312A0</td> <td>RUBBER CABLE-PASSI NG DE=26 DI=15 SP=10</td> <td>1.000</td> <td>PC</td> </tr> <tr> <td>GN1526A0</td> <td>INT. D.=6.9 TH=1.8 O-RIN</td> <td>7.000</td> <td>PC</td> </tr> </tbody> </table>	Code	Description	Qty	UOM	0H2428A2	XECC PLUS WASHING CIRCUIT PLAT	1.000	PC	EL1440A0	WATER SELF CLEANING VALVE	3.000	PC	GN1312A0	RUBBER CABLE-PASSI NG DE=26 DI=15 SP=10	1.000	PC	GN1526A0	INT. D.=6.9 TH=1.8 O-RIN	7.000	PC
			Code	Description	Qty	UOM																																																																														
TB3005B0	TB3132A L=550mm EPDM WHITE-BLUE PIPE	1.000	PC																																																																																	
TB3469A0		1.000	PC																																																																																	
VL1019A0	VIBRATION DETERGENT PUMP	1.000	PC																																																																																	
VL1047A1	D6 PIPE HOLDER - D8 J.G. TERMINAL	1.000	PC																																																																																	
VL1054B0	ONE WASHING SYS INLET DISTRIBUTOR	1.000	PC																																																																																	
VL1065A1	1/4 MALE N.O. PRESSURE SWITCH	1.000	PC																																																																																	
VL1102A1	DETERGENT LINE FILTER + BARBED VNR 6 MM	1.000	PC																																																																																	
VL1128A1	D6 BARBED CHECK VALVE	2.000	PC																																																																																	
VL1165A0	BAM-BB6 STRAIGHT FITTING	1.000	PC																																																																																	
VL1166A0	BB6-AR6 L FITTING	3.000	PC																																																																																	
VL1174C0	D1.2 MM CALIBRATED D1.2 MM	1.000	PC																																																																																	
VL1185A0	2 WAYS PLUS WASHING DISTRIBUTOR	1.000	PC																																																																																	
VM2172A0	LOCKING CLIP FOR PUMP WITH CIRCUIT	6.000	PC																																																																																	
Code	Description	Qty	UOM																																																																																	
0H2428A2	XECC PLUS WASHING CIRCUIT PLAT	1.000	PC																																																																																	
EL1440A0	WATER SELF CLEANING VALVE	3.000	PC																																																																																	
GN1312A0	RUBBER CABLE-PASSI NG DE=26 DI=15 SP=10	1.000	PC																																																																																	
GN1526A0	INT. D.=6.9 TH=1.8 O-RIN	7.000	PC																																																																																	

COMPONENT			SPARE PART																																																																																		
Code	Description	Image	Code	Description	Kit components																																																																																
VL1185A	2 WAYS PLUS WASHING DISTRIBUTOR		KVL1212A	EUR COMPACT PLUS CLEANING SYSTEM KIT	<table border="1"> <thead> <tr> <th>Code</th> <th>Description</th> <th>Qty</th> <th>UOM</th> </tr> </thead> <tbody> <tr> <td>RC1018A0</td> <td>ZINC PLATED D12 ELASTIC CLAMP</td> <td>2.000</td> <td>PC</td> </tr> <tr> <td>RC1019A0</td> <td>D=10 ELASTIC CLAMP</td> <td>14.000</td> <td>PC</td> </tr> <tr> <td>RC1130A0</td> <td>130x2,6 CLAM</td> <td>1.000</td> <td>PC</td> </tr> <tr> <td>RC1131A0</td> <td>200x2,6 BLACK CLAMP</td> <td>1.000</td> <td>PC</td> </tr> <tr> <td>RC1242A0</td> <td>D=10 CLOSED CAP</td> <td>2.000</td> <td>PC</td> </tr> <tr> <td>RC1356A0</td> <td>"STRAIGHT THREADED FEMALE END 8x1/4" BS</td> <td>1.000</td> <td>PC</td> </tr> <tr> <td>TB2821A0</td> <td>EPDM 6X10 L=40MM PIPE</td> <td>6.000</td> <td>PC</td> </tr> <tr> <td>TB3004A0</td> <td>TB2820A L=550mm EPDM BLACK PIPE</td> <td>2.000</td> <td>PC</td> </tr> <tr> <td>TB3005B0</td> <td>TB3132A L=550mm EPDM WHITE-BLUE PIPE</td> <td>1.000</td> <td>PC</td> </tr> <tr> <td>TB3469A0</td> <td></td> <td>1.000</td> <td>PC</td> </tr> <tr> <td>VL1019A0</td> <td>VIBRATION DETERGENT PUMP</td> <td>1.000</td> <td>PC</td> </tr> <tr> <td>VL1047A1</td> <td>D6 PIPE HOLDER - D6 J.G. TERMINAL</td> <td>1.000</td> <td>PC</td> </tr> <tr> <td>VL1054B0</td> <td>ONE WASHING SYS INLET DISTRIBUTOR</td> <td>1.000</td> <td>PC</td> </tr> <tr> <td>VL1065A1</td> <td>1/4 MALE N.O. PRESSURE SWITCH</td> <td>1.000</td> <td>PC</td> </tr> <tr> <td>VL1102A1</td> <td>DETERGENT LINE FILTER + BARBED VNR 6 MM</td> <td>1.000</td> <td>PC</td> </tr> <tr> <td>VL1128A1</td> <td>D6 BARBED CHECK VALVE</td> <td>2.000</td> <td>PC</td> </tr> <tr> <td>VL1165A0</td> <td>BAM-BB6 STRAIGHT FITTING</td> <td>1.000</td> <td>PC</td> </tr> <tr> <td>VL1166A0</td> <td>BB6-AR6 L FITTING</td> <td>3.000</td> <td>PC</td> </tr> <tr> <td>VL1174C0</td> <td>D1.2 MM CALIBRATED D1.2 MM</td> <td>1.000</td> <td>PC</td> </tr> </tbody> </table>	Code	Description	Qty	UOM	RC1018A0	ZINC PLATED D12 ELASTIC CLAMP	2.000	PC	RC1019A0	D=10 ELASTIC CLAMP	14.000	PC	RC1130A0	130x2,6 CLAM	1.000	PC	RC1131A0	200x2,6 BLACK CLAMP	1.000	PC	RC1242A0	D=10 CLOSED CAP	2.000	PC	RC1356A0	"STRAIGHT THREADED FEMALE END 8x1/4" BS	1.000	PC	TB2821A0	EPDM 6X10 L=40MM PIPE	6.000	PC	TB3004A0	TB2820A L=550mm EPDM BLACK PIPE	2.000	PC	TB3005B0	TB3132A L=550mm EPDM WHITE-BLUE PIPE	1.000	PC	TB3469A0		1.000	PC	VL1019A0	VIBRATION DETERGENT PUMP	1.000	PC	VL1047A1	D6 PIPE HOLDER - D6 J.G. TERMINAL	1.000	PC	VL1054B0	ONE WASHING SYS INLET DISTRIBUTOR	1.000	PC	VL1065A1	1/4 MALE N.O. PRESSURE SWITCH	1.000	PC	VL1102A1	DETERGENT LINE FILTER + BARBED VNR 6 MM	1.000	PC	VL1128A1	D6 BARBED CHECK VALVE	2.000	PC	VL1165A0	BAM-BB6 STRAIGHT FITTING	1.000	PC	VL1166A0	BB6-AR6 L FITTING	3.000	PC	VL1174C0	D1.2 MM CALIBRATED D1.2 MM	1.000	PC
Code	Description	Qty	UOM																																																																																		
RC1018A0	ZINC PLATED D12 ELASTIC CLAMP	2.000	PC																																																																																		
RC1019A0	D=10 ELASTIC CLAMP	14.000	PC																																																																																		
RC1130A0	130x2,6 CLAM	1.000	PC																																																																																		
RC1131A0	200x2,6 BLACK CLAMP	1.000	PC																																																																																		
RC1242A0	D=10 CLOSED CAP	2.000	PC																																																																																		
RC1356A0	"STRAIGHT THREADED FEMALE END 8x1/4" BS	1.000	PC																																																																																		
TB2821A0	EPDM 6X10 L=40MM PIPE	6.000	PC																																																																																		
TB3004A0	TB2820A L=550mm EPDM BLACK PIPE	2.000	PC																																																																																		
TB3005B0	TB3132A L=550mm EPDM WHITE-BLUE PIPE	1.000	PC																																																																																		
TB3469A0		1.000	PC																																																																																		
VL1019A0	VIBRATION DETERGENT PUMP	1.000	PC																																																																																		
VL1047A1	D6 PIPE HOLDER - D6 J.G. TERMINAL	1.000	PC																																																																																		
VL1054B0	ONE WASHING SYS INLET DISTRIBUTOR	1.000	PC																																																																																		
VL1065A1	1/4 MALE N.O. PRESSURE SWITCH	1.000	PC																																																																																		
VL1102A1	DETERGENT LINE FILTER + BARBED VNR 6 MM	1.000	PC																																																																																		
VL1128A1	D6 BARBED CHECK VALVE	2.000	PC																																																																																		
VL1165A0	BAM-BB6 STRAIGHT FITTING	1.000	PC																																																																																		
VL1166A0	BB6-AR6 L FITTING	3.000	PC																																																																																		
VL1174C0	D1.2 MM CALIBRATED D1.2 MM	1.000	PC																																																																																		



COMPONENT			SPARE PART																																																																											
Code	Description	Image	Code	Description	Kit components																																																																									
VL1185A	2 WAYS PLUS WASHING DISTRIBUTOR		KVL1212A	EUR COMPACT PLUS CLEANING SYSTEM KIT	<table border="1"> <thead> <tr> <th>Code</th> <th>Description</th> <th>Qty</th> <th>UOM</th> </tr> </thead> <tbody> <tr> <td>VL1185A0</td> <td>2 WAYS PLUS WASHING DISTRIBUTOR</td> <td>1.000</td> <td>PC</td> </tr> <tr> <td>VM2172A0</td> <td>LOCKING CLIP FOR PUMP WITH CIRCUIT</td> <td>6.000</td> <td>PC</td> </tr> </tbody> </table>	Code	Description	Qty	UOM	VL1185A0	2 WAYS PLUS WASHING DISTRIBUTOR	1.000	PC	VM2172A0	LOCKING CLIP FOR PUMP WITH CIRCUIT	6.000	PC																																																													
			Code	Description	Qty	UOM																																																																								
VL1185A0	2 WAYS PLUS WASHING DISTRIBUTOR	1.000	PC																																																																											
VM2172A0	LOCKING CLIP FOR PUMP WITH CIRCUIT	6.000	PC																																																																											
KVL1209A	US PLUS 3 ROTOR ARMS WASHING SYSTEM KIT	<table border="1"> <thead> <tr> <th>Code</th> <th>Description</th> <th>Qty</th> <th>UOM</th> </tr> </thead> <tbody> <tr> <td>0H2354A1</td> <td>XEVC-XEVL PLUS WASHING CIRCUIT PLAT</td> <td>1.000</td> <td>PC</td> </tr> <tr> <td>EL1450A0</td> <td>US SELF-CLEANING WATER SOLENOID</td> <td>4.000</td> <td>PC</td> </tr> <tr> <td>GN1526A0</td> <td>INT. D.=6.9 TH=1.8 O-RING</td> <td>9.000</td> <td>PC</td> </tr> <tr> <td>RC1018A0</td> <td>ZINC PLATED D12 ELASTIC CLAMP</td> <td>12.000</td> <td>PC</td> </tr> <tr> <td>RC1019A0</td> <td>D=10 ELASTIC CLAMP</td> <td>15.000</td> <td>PC</td> </tr> <tr> <td>RC1130A0</td> <td>130x2.6 CLAM</td> <td>1.000</td> <td>PC</td> </tr> <tr> <td>RC1131A0</td> <td>200x2.6 BLACK CLAMP</td> <td>3.000</td> <td>PC</td> </tr> <tr> <td>RC1242A0</td> <td>D=10 CLOSED CAP</td> <td>2.000</td> <td>PC</td> </tr> <tr> <td>RC1356A0</td> <td>"STRAIGHT THREADED FEMALE END 8x1/4" BS</td> <td>1.000</td> <td>PC</td> </tr> <tr> <td>TB2652A0</td> <td></td> <td>1.000</td> <td>PC</td> </tr> <tr> <td>TB2677A0</td> <td></td> <td>1.000</td> <td>PC</td> </tr> <tr> <td>TB2821A0</td> <td>EPDM 6X10 L=40MM PIPE</td> <td>6.000</td> <td>PC</td> </tr> <tr> <td>TB3004A0</td> <td>TB2820A L=550mm EPDM BLACK PIPE</td> <td>2.000</td> <td>PC</td> </tr> <tr> <td>TB3024C0</td> <td></td> <td>3.000</td> <td>PC</td> </tr> <tr> <td>TB3226A0</td> <td></td> <td>1.000</td> <td>PC</td> </tr> <tr> <td>TB3440A0</td> <td>TB3132A L=1050mm EPDM WHITE-BLUE PIPE</td> <td>1.000</td> <td>PC</td> </tr> <tr> <td>VL1019A0</td> <td>VIBRATION DETERGENT PUMP</td> <td>1.000</td> <td>PC</td> </tr> <tr> <td>VL1065A1</td> <td>1/4 MALE N.O. PRESSURE SWITCH</td> <td>1.000</td> <td>PC</td> </tr> </tbody> </table>	Code	Description	Qty	UOM	0H2354A1	XEVC-XEVL PLUS WASHING CIRCUIT PLAT	1.000	PC	EL1450A0	US SELF-CLEANING WATER SOLENOID	4.000	PC	GN1526A0	INT. D.=6.9 TH=1.8 O-RING	9.000	PC	RC1018A0	ZINC PLATED D12 ELASTIC CLAMP	12.000	PC	RC1019A0	D=10 ELASTIC CLAMP	15.000	PC	RC1130A0	130x2.6 CLAM	1.000	PC	RC1131A0	200x2.6 BLACK CLAMP	3.000	PC	RC1242A0	D=10 CLOSED CAP	2.000	PC	RC1356A0	"STRAIGHT THREADED FEMALE END 8x1/4" BS	1.000	PC	TB2652A0		1.000	PC	TB2677A0		1.000	PC	TB2821A0	EPDM 6X10 L=40MM PIPE	6.000	PC	TB3004A0	TB2820A L=550mm EPDM BLACK PIPE	2.000	PC	TB3024C0		3.000	PC	TB3226A0		1.000	PC	TB3440A0	TB3132A L=1050mm EPDM WHITE-BLUE PIPE	1.000	PC	VL1019A0	VIBRATION DETERGENT PUMP	1.000	PC	VL1065A1	1/4 MALE N.O. PRESSURE SWITCH	1.000	PC
Code	Description	Qty	UOM																																																																											
0H2354A1	XEVC-XEVL PLUS WASHING CIRCUIT PLAT	1.000	PC																																																																											
EL1450A0	US SELF-CLEANING WATER SOLENOID	4.000	PC																																																																											
GN1526A0	INT. D.=6.9 TH=1.8 O-RING	9.000	PC																																																																											
RC1018A0	ZINC PLATED D12 ELASTIC CLAMP	12.000	PC																																																																											
RC1019A0	D=10 ELASTIC CLAMP	15.000	PC																																																																											
RC1130A0	130x2.6 CLAM	1.000	PC																																																																											
RC1131A0	200x2.6 BLACK CLAMP	3.000	PC																																																																											
RC1242A0	D=10 CLOSED CAP	2.000	PC																																																																											
RC1356A0	"STRAIGHT THREADED FEMALE END 8x1/4" BS	1.000	PC																																																																											
TB2652A0		1.000	PC																																																																											
TB2677A0		1.000	PC																																																																											
TB2821A0	EPDM 6X10 L=40MM PIPE	6.000	PC																																																																											
TB3004A0	TB2820A L=550mm EPDM BLACK PIPE	2.000	PC																																																																											
TB3024C0		3.000	PC																																																																											
TB3226A0		1.000	PC																																																																											
TB3440A0	TB3132A L=1050mm EPDM WHITE-BLUE PIPE	1.000	PC																																																																											
VL1019A0	VIBRATION DETERGENT PUMP	1.000	PC																																																																											
VL1065A1	1/4 MALE N.O. PRESSURE SWITCH	1.000	PC																																																																											



COMPONENT			SPARE PART																																																																																	
Code	Description	Image	Code	Description	Kit components																																																																															
VL1185A	2 WAYS PLUS WASHING DISTRIBUTOR		KVL1209A	US PLUS 3 ROTOR ARMS WASHING SYSTEM KIT	<table border="1"> <thead> <tr> <th>Code</th> <th>Description</th> <th>Qty</th> <th>UOM</th> </tr> </thead> <tbody> <tr> <td>VL1102A1</td> <td>DETERGENT LINE FILTER + BARBED VNR 6 MM</td> <td>1.000</td> <td>PC</td> </tr> <tr> <td>VL1127A1</td> <td>6mm BARBED T-SHAPED FITTING</td> <td>2.000</td> <td>PC</td> </tr> <tr> <td>VL1128A1</td> <td>D6 BARBED CHECK VALVE</td> <td>3.000</td> <td>PC</td> </tr> <tr> <td>VL1166A0</td> <td>BB6-AR6 L FITTING</td> <td>4.000</td> <td>PC</td> </tr> <tr> <td>VL1167A2</td> <td>GN21 3 ROTOR ARMS B-B FLOW RESTRICTOR</td> <td>1.000</td> <td>PC</td> </tr> <tr> <td>VL1174C0</td> <td>D1.2 MM CALIBRATED D1.2 MM</td> <td>1.000</td> <td>PC</td> </tr> <tr> <td>VL1185A0</td> <td>2 WAYS PLUS WASHING DISTRIBUTOR</td> <td>1.000</td> <td>PC</td> </tr> <tr> <td>VL1186A0</td> <td>3 WAYS PLUS WASHING DISTRIBUTOR</td> <td>1.000</td> <td>PC</td> </tr> <tr> <td>VL1190A0</td> <td>PLUS WASHING SYSTEM INLET DISTRIBUTOR</td> <td>1.000</td> <td>PC</td> </tr> <tr> <td>VL1214A0</td> <td>BAYONET - 6mm BARBED NRV VALVE</td> <td>1.000</td> <td>PC</td> </tr> <tr> <td>VM1605A0</td> <td>CLIP TWIST LOCK DIAM. 10,2-12,7 MM</td> <td>3.000</td> <td>PC</td> </tr> <tr> <td>VM2172A0</td> <td>LOCKING CLIP FOR PUMP WITH CIRCUIT</td> <td>9.000</td> <td>PC</td> </tr> </tbody> </table>	Code	Description	Qty	UOM	VL1102A1	DETERGENT LINE FILTER + BARBED VNR 6 MM	1.000	PC	VL1127A1	6mm BARBED T-SHAPED FITTING	2.000	PC	VL1128A1	D6 BARBED CHECK VALVE	3.000	PC	VL1166A0	BB6-AR6 L FITTING	4.000	PC	VL1167A2	GN21 3 ROTOR ARMS B-B FLOW RESTRICTOR	1.000	PC	VL1174C0	D1.2 MM CALIBRATED D1.2 MM	1.000	PC	VL1185A0	2 WAYS PLUS WASHING DISTRIBUTOR	1.000	PC	VL1186A0	3 WAYS PLUS WASHING DISTRIBUTOR	1.000	PC	VL1190A0	PLUS WASHING SYSTEM INLET DISTRIBUTOR	1.000	PC	VL1214A0	BAYONET - 6mm BARBED NRV VALVE	1.000	PC	VM1605A0	CLIP TWIST LOCK DIAM. 10,2-12,7 MM	3.000	PC	VM2172A0	LOCKING CLIP FOR PUMP WITH CIRCUIT	9.000	PC	KVL1207A	US PLUS 1 ROTOR ARM WASHING SYSTEM KIT	<table border="1"> <thead> <tr> <th>Code</th> <th>Description</th> <th>Qty</th> <th>UOM</th> </tr> </thead> <tbody> <tr> <td>0H2354A1</td> <td>XEVC-XEVL PLUS WASHING CIRCUIT PLAT</td> <td>1.000</td> <td>PC</td> </tr> <tr> <td>EL1450A0</td> <td>US SELF-CLEANING WATER SOLENOID</td> <td>3.000</td> <td>PC</td> </tr> <tr> <td>GN1526A0</td> <td>INT. D.=6.9 TH=1.8 O-RING</td> <td>7.000</td> <td>PC</td> </tr> <tr> <td>RC1018A0</td> <td>ZINC PLATED D12 ELASTIC CLAMP</td> <td>2.000</td> <td>PC</td> </tr> <tr> <td>RC1019A0</td> <td>D=10 ELASTIC CLAMP</td> <td>14.000</td> <td>PC</td> </tr> </tbody> </table>	Code	Description	Qty	UOM	0H2354A1	XEVC-XEVL PLUS WASHING CIRCUIT PLAT	1.000	PC	EL1450A0	US SELF-CLEANING WATER SOLENOID	3.000	PC	GN1526A0	INT. D.=6.9 TH=1.8 O-RING	7.000	PC	RC1018A0	ZINC PLATED D12 ELASTIC CLAMP	2.000	PC	RC1019A0	D=10 ELASTIC CLAMP	14.000	PC
			Code	Description	Qty	UOM																																																																														
VL1102A1	DETERGENT LINE FILTER + BARBED VNR 6 MM	1.000	PC																																																																																	
VL1127A1	6mm BARBED T-SHAPED FITTING	2.000	PC																																																																																	
VL1128A1	D6 BARBED CHECK VALVE	3.000	PC																																																																																	
VL1166A0	BB6-AR6 L FITTING	4.000	PC																																																																																	
VL1167A2	GN21 3 ROTOR ARMS B-B FLOW RESTRICTOR	1.000	PC																																																																																	
VL1174C0	D1.2 MM CALIBRATED D1.2 MM	1.000	PC																																																																																	
VL1185A0	2 WAYS PLUS WASHING DISTRIBUTOR	1.000	PC																																																																																	
VL1186A0	3 WAYS PLUS WASHING DISTRIBUTOR	1.000	PC																																																																																	
VL1190A0	PLUS WASHING SYSTEM INLET DISTRIBUTOR	1.000	PC																																																																																	
VL1214A0	BAYONET - 6mm BARBED NRV VALVE	1.000	PC																																																																																	
VM1605A0	CLIP TWIST LOCK DIAM. 10,2-12,7 MM	3.000	PC																																																																																	
VM2172A0	LOCKING CLIP FOR PUMP WITH CIRCUIT	9.000	PC																																																																																	
Code	Description	Qty	UOM																																																																																	
0H2354A1	XEVC-XEVL PLUS WASHING CIRCUIT PLAT	1.000	PC																																																																																	
EL1450A0	US SELF-CLEANING WATER SOLENOID	3.000	PC																																																																																	
GN1526A0	INT. D.=6.9 TH=1.8 O-RING	7.000	PC																																																																																	
RC1018A0	ZINC PLATED D12 ELASTIC CLAMP	2.000	PC																																																																																	
RC1019A0	D=10 ELASTIC CLAMP	14.000	PC																																																																																	



COMPONENT			SPARE PART																																																																														
Code	Description	Image	Code	Description	Kit components																																																																												
VL1185A	2 WAYS PLUS WASHING DISTRIBUTOR		KVL1207A	US PLUS 1 ROTOR ARM WASHING SYSTEM KIT	<table border="1"> <thead> <tr> <th>Code</th> <th>Description</th> <th>Qty</th> <th>UOM</th> </tr> </thead> <tbody> <tr> <td>RC1130A0</td> <td>130x2.6 CLAM</td> <td>1.000</td> <td>PC</td> </tr> <tr> <td>RC1131A0</td> <td>200x2.6 BLACK CLAMP</td> <td>2.000</td> <td>PC</td> </tr> <tr> <td>RC1242A0</td> <td>D=10 CLOSED CAP</td> <td>2.000</td> <td>PC</td> </tr> <tr> <td>RC1356A0</td> <td>"STRAIGHT THREADED FEMALE END 8x1/4" BS</td> <td>1.000</td> <td>PC</td> </tr> <tr> <td>TB2821A0</td> <td>EPDM 6X10 L=40MM PIPE</td> <td>6.000</td> <td>PC</td> </tr> <tr> <td>TB3004A0</td> <td>TB2820A L=550mm EPDM BLACK PIPE</td> <td>1.000</td> <td>PC</td> </tr> <tr> <td>TB3005B0</td> <td>TB3132A L=550mm EPDM WHITE-BLUE PIPE</td> <td>1.000</td> <td>PC</td> </tr> <tr> <td>TB3225B0</td> <td>TB2820A-TAN K-WASHYNG SYS CONNECTION</td> <td>1.000</td> <td>PC</td> </tr> <tr> <td>TB3252A0</td> <td>TB3252A0</td> <td>1.000</td> <td>PC</td> </tr> <tr> <td>VL1019A0</td> <td>VIBRATION DETERGENT PUMP</td> <td>1.000</td> <td>PC</td> </tr> <tr> <td>VL1047A1</td> <td>D6 PIPE HOLDER - D8 J.G. TERMINAL</td> <td>1.000</td> <td>PC</td> </tr> <tr> <td>VL1065A1</td> <td>1/4 MALE N.O. PRESSURE SWITCH</td> <td>1.000</td> <td>PC</td> </tr> <tr> <td>VL1102A1</td> <td>DETERGENT LINE FILTER + BARBED VNR 6 MM</td> <td>1.000</td> <td>PC</td> </tr> <tr> <td>VL1128A1</td> <td>D6 BARBED CHECK VALVE</td> <td>2.000</td> <td>PC</td> </tr> <tr> <td>VL1166A0</td> <td>BB6-AR6 L FITTING</td> <td>3.000</td> <td>PC</td> </tr> <tr> <td>VL1174C0</td> <td>D1.2 MM CALIBRATED D1.2 MM</td> <td>1.000</td> <td>PC</td> </tr> <tr> <td>VL1185A0</td> <td>2 WAYS PLUS WASHING DISTRIBUTOR</td> <td>1.000</td> <td>PC</td> </tr> <tr> <td>VL1190A0</td> <td>PLUS WASHING SYSTEM INLET DISTRIBUTOR</td> <td>1.000</td> <td>PC</td> </tr> </tbody> </table>	Code	Description	Qty	UOM	RC1130A0	130x2.6 CLAM	1.000	PC	RC1131A0	200x2.6 BLACK CLAMP	2.000	PC	RC1242A0	D=10 CLOSED CAP	2.000	PC	RC1356A0	"STRAIGHT THREADED FEMALE END 8x1/4" BS	1.000	PC	TB2821A0	EPDM 6X10 L=40MM PIPE	6.000	PC	TB3004A0	TB2820A L=550mm EPDM BLACK PIPE	1.000	PC	TB3005B0	TB3132A L=550mm EPDM WHITE-BLUE PIPE	1.000	PC	TB3225B0	TB2820A-TAN K-WASHYNG SYS CONNECTION	1.000	PC	TB3252A0	TB3252A0	1.000	PC	VL1019A0	VIBRATION DETERGENT PUMP	1.000	PC	VL1047A1	D6 PIPE HOLDER - D8 J.G. TERMINAL	1.000	PC	VL1065A1	1/4 MALE N.O. PRESSURE SWITCH	1.000	PC	VL1102A1	DETERGENT LINE FILTER + BARBED VNR 6 MM	1.000	PC	VL1128A1	D6 BARBED CHECK VALVE	2.000	PC	VL1166A0	BB6-AR6 L FITTING	3.000	PC	VL1174C0	D1.2 MM CALIBRATED D1.2 MM	1.000	PC	VL1185A0	2 WAYS PLUS WASHING DISTRIBUTOR	1.000	PC	VL1190A0	PLUS WASHING SYSTEM INLET DISTRIBUTOR	1.000	PC
					Code	Description	Qty	UOM																																																																									
					RC1130A0	130x2.6 CLAM	1.000	PC																																																																									
					RC1131A0	200x2.6 BLACK CLAMP	2.000	PC																																																																									
					RC1242A0	D=10 CLOSED CAP	2.000	PC																																																																									
					RC1356A0	"STRAIGHT THREADED FEMALE END 8x1/4" BS	1.000	PC																																																																									
					TB2821A0	EPDM 6X10 L=40MM PIPE	6.000	PC																																																																									
					TB3004A0	TB2820A L=550mm EPDM BLACK PIPE	1.000	PC																																																																									
					TB3005B0	TB3132A L=550mm EPDM WHITE-BLUE PIPE	1.000	PC																																																																									
					TB3225B0	TB2820A-TAN K-WASHYNG SYS CONNECTION	1.000	PC																																																																									
					TB3252A0	TB3252A0	1.000	PC																																																																									
					VL1019A0	VIBRATION DETERGENT PUMP	1.000	PC																																																																									
					VL1047A1	D6 PIPE HOLDER - D8 J.G. TERMINAL	1.000	PC																																																																									
					VL1065A1	1/4 MALE N.O. PRESSURE SWITCH	1.000	PC																																																																									
					VL1102A1	DETERGENT LINE FILTER + BARBED VNR 6 MM	1.000	PC																																																																									
					VL1128A1	D6 BARBED CHECK VALVE	2.000	PC																																																																									
					VL1166A0	BB6-AR6 L FITTING	3.000	PC																																																																									
					VL1174C0	D1.2 MM CALIBRATED D1.2 MM	1.000	PC																																																																									
					VL1185A0	2 WAYS PLUS WASHING DISTRIBUTOR	1.000	PC																																																																									
					VL1190A0	PLUS WASHING SYSTEM INLET DISTRIBUTOR	1.000	PC																																																																									





COMPONENT			SPARE PART																																																																			
Code	Description	Image	Code	Description	Kit components																																																																	
VL1185A	2 WAYS PLUS WASHING DISTRIBUTOR		KVL1207A	US PLUS 1 ROTOR ARM WASHING SYSTEM KIT	<table border="1"> <thead> <tr> <th>Code</th> <th>Description</th> <th>Qty</th> <th>UOM</th> </tr> </thead> <tbody> <tr> <td>VL1214A0</td> <td>BAYONET - 6mm BARBED NRV VALVE</td> <td>1.000</td> <td>PC</td> </tr> <tr> <td>VM1605A0</td> <td>CLIP TWIST LOCK DIAM. 10,2-12,7 MM</td> <td>3.000</td> <td>PC</td> </tr> <tr> <td>VM2172A0</td> <td>LOCKING CLIP FOR PUMP WITH CIRCUIT</td> <td>3.000</td> <td>PC</td> </tr> </tbody> </table>	Code	Description	Qty	UOM	VL1214A0	BAYONET - 6mm BARBED NRV VALVE	1.000	PC	VM1605A0	CLIP TWIST LOCK DIAM. 10,2-12,7 MM	3.000	PC	VM2172A0	LOCKING CLIP FOR PUMP WITH CIRCUIT	3.000	PC																																																	
			Code	Description	Qty	UOM																																																																
VL1214A0	BAYONET - 6mm BARBED NRV VALVE	1.000	PC																																																																			
VM1605A0	CLIP TWIST LOCK DIAM. 10,2-12,7 MM	3.000	PC																																																																			
VM2172A0	LOCKING CLIP FOR PUMP WITH CIRCUIT	3.000	PC																																																																			
KVL1183A	1 ROTOR ARM PLUS CLEANING SYSTEM KIT	<table border="1"> <thead> <tr> <th>Code</th> <th>Description</th> <th>Qty</th> <th>UOM</th> </tr> </thead> <tbody> <tr> <td>0H2354A1</td> <td>XEVC-XEVL PLUS WASHING CIRCUIT PLAT</td> <td>1.000</td> <td>PC</td> </tr> <tr> <td>EL1440A0</td> <td>WATER SELF CLEANING VALVE</td> <td>3.000</td> <td>PC</td> </tr> <tr> <td>GN1526A0</td> <td>INT. D.=6.9 TH=1.8 O-RIN</td> <td>7.000</td> <td>PC</td> </tr> <tr> <td>RC1018A0</td> <td>ZINC PLATED D12 ELASTIC CLAMP</td> <td>2.000</td> <td>PC</td> </tr> <tr> <td>RC1019A0</td> <td>D=10 ELASTIC CLAMP</td> <td>14.000</td> <td>PC</td> </tr> <tr> <td>RC1130A0</td> <td>130x2,6 CLAM</td> <td>1.000</td> <td>PC</td> </tr> <tr> <td>RC1131A0</td> <td>200x2,6 BLACK CLAMP</td> <td>2.000</td> <td>PC</td> </tr> <tr> <td>RC1242A0</td> <td>D=10 CLOSED CAP</td> <td>2.000</td> <td>PC</td> </tr> <tr> <td>RC1356A0</td> <td>"STRAIGHT THREADED FEMALE END 8x1/4" BS</td> <td>1.000</td> <td>PC</td> </tr> <tr> <td>TB2821A0</td> <td>EPDM 6X10 L=40MM PIPE</td> <td>6.000</td> <td>PC</td> </tr> <tr> <td>TB3004A0</td> <td>TB2820A L=550mm EPDM BLACK PIPE</td> <td>1.000</td> <td>PC</td> </tr> <tr> <td>TB3005B0</td> <td>TB3132A L=550mm EPDM WHITE-BLUE PIPE</td> <td>1.000</td> <td>PC</td> </tr> <tr> <td>TB3225B0</td> <td>TB2820A-TAN K-WASHYNG SYS CONNECTION</td> <td>1.000</td> <td>PC</td> </tr> <tr> <td>TB3252A0</td> <td>TB3252A0</td> <td>1.000</td> <td>PC</td> </tr> <tr> <td>VL1019A0</td> <td>VIBRATION DETERGENT PUMP</td> <td>1.000</td> <td>PC</td> </tr> <tr> <td>VL1047A1</td> <td>D6 PIPE HOLDER - D8 J.G. TERMINAL</td> <td>1.000</td> <td>PC</td> </tr> </tbody> </table>	Code	Description	Qty	UOM	0H2354A1	XEVC-XEVL PLUS WASHING CIRCUIT PLAT	1.000	PC	EL1440A0	WATER SELF CLEANING VALVE	3.000	PC	GN1526A0	INT. D.=6.9 TH=1.8 O-RIN	7.000	PC	RC1018A0	ZINC PLATED D12 ELASTIC CLAMP	2.000	PC	RC1019A0	D=10 ELASTIC CLAMP	14.000	PC	RC1130A0	130x2,6 CLAM	1.000	PC	RC1131A0	200x2,6 BLACK CLAMP	2.000	PC	RC1242A0	D=10 CLOSED CAP	2.000	PC	RC1356A0	"STRAIGHT THREADED FEMALE END 8x1/4" BS	1.000	PC	TB2821A0	EPDM 6X10 L=40MM PIPE	6.000	PC	TB3004A0	TB2820A L=550mm EPDM BLACK PIPE	1.000	PC	TB3005B0	TB3132A L=550mm EPDM WHITE-BLUE PIPE	1.000	PC	TB3225B0	TB2820A-TAN K-WASHYNG SYS CONNECTION	1.000	PC	TB3252A0	TB3252A0	1.000	PC	VL1019A0	VIBRATION DETERGENT PUMP	1.000	PC	VL1047A1	D6 PIPE HOLDER - D8 J.G. TERMINAL	1.000	PC
Code	Description	Qty	UOM																																																																			
0H2354A1	XEVC-XEVL PLUS WASHING CIRCUIT PLAT	1.000	PC																																																																			
EL1440A0	WATER SELF CLEANING VALVE	3.000	PC																																																																			
GN1526A0	INT. D.=6.9 TH=1.8 O-RIN	7.000	PC																																																																			
RC1018A0	ZINC PLATED D12 ELASTIC CLAMP	2.000	PC																																																																			
RC1019A0	D=10 ELASTIC CLAMP	14.000	PC																																																																			
RC1130A0	130x2,6 CLAM	1.000	PC																																																																			
RC1131A0	200x2,6 BLACK CLAMP	2.000	PC																																																																			
RC1242A0	D=10 CLOSED CAP	2.000	PC																																																																			
RC1356A0	"STRAIGHT THREADED FEMALE END 8x1/4" BS	1.000	PC																																																																			
TB2821A0	EPDM 6X10 L=40MM PIPE	6.000	PC																																																																			
TB3004A0	TB2820A L=550mm EPDM BLACK PIPE	1.000	PC																																																																			
TB3005B0	TB3132A L=550mm EPDM WHITE-BLUE PIPE	1.000	PC																																																																			
TB3225B0	TB2820A-TAN K-WASHYNG SYS CONNECTION	1.000	PC																																																																			
TB3252A0	TB3252A0	1.000	PC																																																																			
VL1019A0	VIBRATION DETERGENT PUMP	1.000	PC																																																																			
VL1047A1	D6 PIPE HOLDER - D8 J.G. TERMINAL	1.000	PC																																																																			



COMPONENT			SPARE PART																																														
Code	Description	Image	Code	Description	Kit components																																												
VL1185A	2 WAYS PLUS WASHING DISTRIBUTOR		KVL1183A	1 ROTOR ARM PLUS CLEANING SYSTEM KIT	<table border="1"> <thead> <tr> <th>Code</th> <th>Description</th> <th>Qty</th> <th>UOM</th> </tr> </thead> <tbody> <tr> <td>VL1065A1</td> <td>1/4 MALE N.O. PRESSURE SWITCH</td> <td>1.000</td> <td>PC</td> </tr> <tr> <td>VL1102A1</td> <td>DETERGENT LINE FILTER + BARBED VNR 6 MM</td> <td>1.000</td> <td>PC</td> </tr> <tr> <td>VL1128A1</td> <td>D6 BARBED CHECK VALVE</td> <td>2.000</td> <td>PC</td> </tr> <tr> <td>VL1166A0</td> <td>BB6-AR6 L FITTING</td> <td>3.000</td> <td>PC</td> </tr> <tr> <td>VL1174C0</td> <td>D1.2 MM CALIBRATED D1.2 MM</td> <td>1.000</td> <td>PC</td> </tr> <tr> <td>VL1185A0</td> <td>2 WAYS PLUS WASHING DISTRIBUTOR</td> <td>1.000</td> <td>PC</td> </tr> <tr> <td>VL1190A0</td> <td>PLUS WASHING SYSTEM INLET DISTRIBUTOR</td> <td>1.000</td> <td>PC</td> </tr> <tr> <td>VL1214A0</td> <td>BAYONET - 6mm BARBED NRV VALVE</td> <td>1.000</td> <td>PC</td> </tr> <tr> <td>VM1605A0</td> <td>CLIP TWIST LOCK DIAM. 10,2-12,7 MM</td> <td>3.000</td> <td>PC</td> </tr> <tr> <td>VM2172A0</td> <td>LOCKING CLIP FOR PUMP WITH CIRCUIT</td> <td>4.000</td> <td>PC</td> </tr> </tbody> </table>	Code	Description	Qty	UOM	VL1065A1	1/4 MALE N.O. PRESSURE SWITCH	1.000	PC	VL1102A1	DETERGENT LINE FILTER + BARBED VNR 6 MM	1.000	PC	VL1128A1	D6 BARBED CHECK VALVE	2.000	PC	VL1166A0	BB6-AR6 L FITTING	3.000	PC	VL1174C0	D1.2 MM CALIBRATED D1.2 MM	1.000	PC	VL1185A0	2 WAYS PLUS WASHING DISTRIBUTOR	1.000	PC	VL1190A0	PLUS WASHING SYSTEM INLET DISTRIBUTOR	1.000	PC	VL1214A0	BAYONET - 6mm BARBED NRV VALVE	1.000	PC	VM1605A0	CLIP TWIST LOCK DIAM. 10,2-12,7 MM	3.000	PC	VM2172A0	LOCKING CLIP FOR PUMP WITH CIRCUIT	4.000	PC
			Code	Description	Qty	UOM																																											
VL1065A1	1/4 MALE N.O. PRESSURE SWITCH	1.000	PC																																														
VL1102A1	DETERGENT LINE FILTER + BARBED VNR 6 MM	1.000	PC																																														
VL1128A1	D6 BARBED CHECK VALVE	2.000	PC																																														
VL1166A0	BB6-AR6 L FITTING	3.000	PC																																														
VL1174C0	D1.2 MM CALIBRATED D1.2 MM	1.000	PC																																														
VL1185A0	2 WAYS PLUS WASHING DISTRIBUTOR	1.000	PC																																														
VL1190A0	PLUS WASHING SYSTEM INLET DISTRIBUTOR	1.000	PC																																														
VL1214A0	BAYONET - 6mm BARBED NRV VALVE	1.000	PC																																														
VM1605A0	CLIP TWIST LOCK DIAM. 10,2-12,7 MM	3.000	PC																																														
VM2172A0	LOCKING CLIP FOR PUMP WITH CIRCUIT	4.000	PC																																														
KVL0683A	>12/2019 1 ROTOR ARM PLUS WASH PUMP KIT	<table border="1"> <thead> <tr> <th>Code</th> <th>Description</th> <th>Qty</th> <th>UOM</th> </tr> </thead> <tbody> <tr> <td>GN1526A0</td> <td>INT. D.=6.9 TH=1.8 O-RIN</td> <td>2.000</td> <td>PC</td> </tr> <tr> <td>RC1019A0</td> <td>D=10 ELASTIC CLAMP</td> <td>4.000</td> <td>PC</td> </tr> <tr> <td>RC1130A0</td> <td>130x2,6 CLAM</td> <td>1.000</td> <td>PC</td> </tr> <tr> <td>RC1131A0</td> <td>200x2,6 BLACK CLAMP</td> <td>2.000</td> <td>PC</td> </tr> <tr> <td>RC1242A0</td> <td>D=10 CLOSED CAP</td> <td>2.000</td> <td>PC</td> </tr> <tr> <td>TB2821A0</td> <td>EPDM 6X10 L=40MM PIPE</td> <td>3.000</td> <td>PC</td> </tr> <tr> <td>VL1019A0</td> <td>VIBRATION DETERGENT PUMP</td> <td>1.000</td> <td>PC</td> </tr> <tr> <td>VL1128A1</td> <td>D6 BARBED CHECK VALVE</td> <td>1.000</td> <td>PC</td> </tr> <tr> <td>VL1174C0</td> <td>D1.2 MM CALIBRATED D1.2 MM</td> <td>1.000</td> <td>PC</td> </tr> <tr> <td>VL1185A0</td> <td>2 WAYS PLUS WASHING DISTRIBUTOR</td> <td>1.000</td> <td>PC</td> </tr> </tbody> </table>	Code	Description	Qty	UOM	GN1526A0	INT. D.=6.9 TH=1.8 O-RIN	2.000	PC	RC1019A0	D=10 ELASTIC CLAMP	4.000	PC	RC1130A0	130x2,6 CLAM	1.000	PC	RC1131A0	200x2,6 BLACK CLAMP	2.000	PC	RC1242A0	D=10 CLOSED CAP	2.000	PC	TB2821A0	EPDM 6X10 L=40MM PIPE	3.000	PC	VL1019A0	VIBRATION DETERGENT PUMP	1.000	PC	VL1128A1	D6 BARBED CHECK VALVE	1.000	PC	VL1174C0	D1.2 MM CALIBRATED D1.2 MM	1.000	PC	VL1185A0	2 WAYS PLUS WASHING DISTRIBUTOR	1.000	PC			
Code	Description	Qty	UOM																																														
GN1526A0	INT. D.=6.9 TH=1.8 O-RIN	2.000	PC																																														
RC1019A0	D=10 ELASTIC CLAMP	4.000	PC																																														
RC1130A0	130x2,6 CLAM	1.000	PC																																														
RC1131A0	200x2,6 BLACK CLAMP	2.000	PC																																														
RC1242A0	D=10 CLOSED CAP	2.000	PC																																														
TB2821A0	EPDM 6X10 L=40MM PIPE	3.000	PC																																														
VL1019A0	VIBRATION DETERGENT PUMP	1.000	PC																																														
VL1128A1	D6 BARBED CHECK VALVE	1.000	PC																																														
VL1174C0	D1.2 MM CALIBRATED D1.2 MM	1.000	PC																																														
VL1185A0	2 WAYS PLUS WASHING DISTRIBUTOR	1.000	PC																																														



COMPONENT			SPARE PART																																																																														
Code	Description	Image	Code	Description	Kit components																																																																												
VL1185A	2 WAYS PLUS WASHING DISTRIBUTOR		KVL0683A	>12/2019 1 ROTOR ARM PLUS WASH PUMP KIT	<table border="1"> <thead> <tr> <th>Code</th> <th>Description</th> <th>Qty</th> <th>UOM</th> </tr> </thead> <tbody> <tr> <td>VL1190A0</td> <td>PLUS WASHING SYSTEM INLET DISTRIBUTOR</td> <td>1.000</td> <td>PC</td> </tr> <tr> <td>VM2172A0</td> <td>LOCKING CLIP FOR PUMP WITH CIRCUIT</td> <td>1.000</td> <td>PC</td> </tr> </tbody> </table>	Code	Description	Qty	UOM	VL1190A0	PLUS WASHING SYSTEM INLET DISTRIBUTOR	1.000	PC	VM2172A0	LOCKING CLIP FOR PUMP WITH CIRCUIT	1.000	PC																																																																
Code	Description	Qty	UOM																																																																														
VL1190A0	PLUS WASHING SYSTEM INLET DISTRIBUTOR	1.000	PC																																																																														
VM2172A0	LOCKING CLIP FOR PUMP WITH CIRCUIT	1.000	PC																																																																														
VL1190A	PLUS WASHING SYSTEM INLET DISTRIBUTOR		KVL1209A	US PLUS 3 ROTOR ARMS WASHING SYSTEM KIT	<table border="1"> <thead> <tr> <th>Code</th> <th>Description</th> <th>Qty</th> <th>UOM</th> </tr> </thead> <tbody> <tr> <td>0H2354A1</td> <td>XEVC-XEVL PLUS WASHING CIRCUIT PLAT</td> <td>1.000</td> <td>PC</td> </tr> <tr> <td>EL1450A0</td> <td>US SELF-CLEANING WATER SOLENOID</td> <td>4.000</td> <td>PC</td> </tr> <tr> <td>GN1526A0</td> <td>INT. D.=6.9 TH=1.8 O-RING</td> <td>9.000</td> <td>PC</td> </tr> <tr> <td>RC1018A0</td> <td>ZINC PLATED D12 ELASTIC CLAMP</td> <td>12.000</td> <td>PC</td> </tr> <tr> <td>RC1019A0</td> <td>D=10 ELASTIC CLAMP</td> <td>15.000</td> <td>PC</td> </tr> <tr> <td>RC1130A0</td> <td>130x2.6 CLAM</td> <td>1.000</td> <td>PC</td> </tr> <tr> <td>RC1131A0</td> <td>200x2.6 BLACK CLAMP</td> <td>3.000</td> <td>PC</td> </tr> <tr> <td>RC1242A0</td> <td>D=10 CLOSED CAP</td> <td>2.000</td> <td>PC</td> </tr> <tr> <td>RC1356A0</td> <td>"STRAIGHT THREADED FEMALE END 8x1/4" BS</td> <td>1.000</td> <td>PC</td> </tr> <tr> <td>TB2652A0</td> <td></td> <td>1.000</td> <td>PC</td> </tr> <tr> <td>TB2677A0</td> <td></td> <td>1.000</td> <td>PC</td> </tr> <tr> <td>TB2821A0</td> <td>EPDM 6X10 L=40MM PIPE</td> <td>6.000</td> <td>PC</td> </tr> <tr> <td>TB3004A0</td> <td>TB2820A L=550mm EPDM BLACK PIPE</td> <td>2.000</td> <td>PC</td> </tr> <tr> <td>TB3024C0</td> <td></td> <td>3.000</td> <td>PC</td> </tr> <tr> <td>TB3226A0</td> <td></td> <td>1.000</td> <td>PC</td> </tr> <tr> <td>TB3440A0</td> <td>TB3132A L=1050mm EPDM WHITE-BLUE PIPE</td> <td>1.000</td> <td>PC</td> </tr> <tr> <td>VL1019A0</td> <td>VIBRATION DETERGENT PUMP</td> <td>1.000</td> <td>PC</td> </tr> <tr> <td>VL1065A1</td> <td>1/4 MALE N.O. PRESSURE SWITCH</td> <td>1.000</td> <td>PC</td> </tr> </tbody> </table>	Code	Description	Qty	UOM	0H2354A1	XEVC-XEVL PLUS WASHING CIRCUIT PLAT	1.000	PC	EL1450A0	US SELF-CLEANING WATER SOLENOID	4.000	PC	GN1526A0	INT. D.=6.9 TH=1.8 O-RING	9.000	PC	RC1018A0	ZINC PLATED D12 ELASTIC CLAMP	12.000	PC	RC1019A0	D=10 ELASTIC CLAMP	15.000	PC	RC1130A0	130x2.6 CLAM	1.000	PC	RC1131A0	200x2.6 BLACK CLAMP	3.000	PC	RC1242A0	D=10 CLOSED CAP	2.000	PC	RC1356A0	"STRAIGHT THREADED FEMALE END 8x1/4" BS	1.000	PC	TB2652A0		1.000	PC	TB2677A0		1.000	PC	TB2821A0	EPDM 6X10 L=40MM PIPE	6.000	PC	TB3004A0	TB2820A L=550mm EPDM BLACK PIPE	2.000	PC	TB3024C0		3.000	PC	TB3226A0		1.000	PC	TB3440A0	TB3132A L=1050mm EPDM WHITE-BLUE PIPE	1.000	PC	VL1019A0	VIBRATION DETERGENT PUMP	1.000	PC	VL1065A1	1/4 MALE N.O. PRESSURE SWITCH	1.000	PC
Code	Description	Qty	UOM																																																																														
0H2354A1	XEVC-XEVL PLUS WASHING CIRCUIT PLAT	1.000	PC																																																																														
EL1450A0	US SELF-CLEANING WATER SOLENOID	4.000	PC																																																																														
GN1526A0	INT. D.=6.9 TH=1.8 O-RING	9.000	PC																																																																														
RC1018A0	ZINC PLATED D12 ELASTIC CLAMP	12.000	PC																																																																														
RC1019A0	D=10 ELASTIC CLAMP	15.000	PC																																																																														
RC1130A0	130x2.6 CLAM	1.000	PC																																																																														
RC1131A0	200x2.6 BLACK CLAMP	3.000	PC																																																																														
RC1242A0	D=10 CLOSED CAP	2.000	PC																																																																														
RC1356A0	"STRAIGHT THREADED FEMALE END 8x1/4" BS	1.000	PC																																																																														
TB2652A0		1.000	PC																																																																														
TB2677A0		1.000	PC																																																																														
TB2821A0	EPDM 6X10 L=40MM PIPE	6.000	PC																																																																														
TB3004A0	TB2820A L=550mm EPDM BLACK PIPE	2.000	PC																																																																														
TB3024C0		3.000	PC																																																																														
TB3226A0		1.000	PC																																																																														
TB3440A0	TB3132A L=1050mm EPDM WHITE-BLUE PIPE	1.000	PC																																																																														
VL1019A0	VIBRATION DETERGENT PUMP	1.000	PC																																																																														
VL1065A1	1/4 MALE N.O. PRESSURE SWITCH	1.000	PC																																																																														



COMPONENT			SPARE PART																																																																																	
Code	Description	Image	Code	Description	Kit components																																																																															
VL1190A	PLUS WASHING SYSTEM INLET DISTRIBUTOR		KVL1209A	US PLUS 3 ROTOR ARMS WASHING SYSTEM KIT	<table border="1"> <thead> <tr> <th>Code</th> <th>Description</th> <th>Qty</th> <th>UOM</th> </tr> </thead> <tbody> <tr> <td>VL1102A1</td> <td>DETERGENT LINE FILTER + BARBED VNR 6 MM</td> <td>1.000</td> <td>PC</td> </tr> <tr> <td>VL1127A1</td> <td>6mm BARBED T-SHAPED FITTING</td> <td>2.000</td> <td>PC</td> </tr> <tr> <td>VL1128A1</td> <td>D6 BARBED CHECK VALVE</td> <td>3.000</td> <td>PC</td> </tr> <tr> <td>VL1166A0</td> <td>BB6-AR6 L FITTING</td> <td>4.000</td> <td>PC</td> </tr> <tr> <td>VL1167A2</td> <td>GN21 3 ROTOR ARMS B-B FLOW RESTRICTOR</td> <td>1.000</td> <td>PC</td> </tr> <tr> <td>VL1174C0</td> <td>D1.2 MM CALIBRATED D1.2 MM</td> <td>1.000</td> <td>PC</td> </tr> <tr> <td>VL1185A0</td> <td>2 WAYS PLUS WASHING DISTRIBUTOR</td> <td>1.000</td> <td>PC</td> </tr> <tr> <td>VL1186A0</td> <td>3 WAYS PLUS WASHING DISTRIBUTOR</td> <td>1.000</td> <td>PC</td> </tr> <tr> <td>VL1190A0</td> <td>PLUS WASHING SYSTEM INLET DISTRIBUTOR</td> <td>1.000</td> <td>PC</td> </tr> <tr> <td>VL1214A0</td> <td>BAYONET - 6mm BARBED NRV VALVE</td> <td>1.000</td> <td>PC</td> </tr> <tr> <td>VM1605A0</td> <td>CLIP TWIST LOCK DIAM. 10,2-12,7 MM</td> <td>3.000</td> <td>PC</td> </tr> <tr> <td>VM2172A0</td> <td>LOCKING CLIP FOR PUMP WITH CIRCUIT</td> <td>9.000</td> <td>PC</td> </tr> </tbody> </table>	Code	Description	Qty	UOM	VL1102A1	DETERGENT LINE FILTER + BARBED VNR 6 MM	1.000	PC	VL1127A1	6mm BARBED T-SHAPED FITTING	2.000	PC	VL1128A1	D6 BARBED CHECK VALVE	3.000	PC	VL1166A0	BB6-AR6 L FITTING	4.000	PC	VL1167A2	GN21 3 ROTOR ARMS B-B FLOW RESTRICTOR	1.000	PC	VL1174C0	D1.2 MM CALIBRATED D1.2 MM	1.000	PC	VL1185A0	2 WAYS PLUS WASHING DISTRIBUTOR	1.000	PC	VL1186A0	3 WAYS PLUS WASHING DISTRIBUTOR	1.000	PC	VL1190A0	PLUS WASHING SYSTEM INLET DISTRIBUTOR	1.000	PC	VL1214A0	BAYONET - 6mm BARBED NRV VALVE	1.000	PC	VM1605A0	CLIP TWIST LOCK DIAM. 10,2-12,7 MM	3.000	PC	VM2172A0	LOCKING CLIP FOR PUMP WITH CIRCUIT	9.000	PC	KVL1208A	US PLUS 2 ROTOR ARMS WASHING SYSTEM KIT	<table border="1"> <thead> <tr> <th>Code</th> <th>Description</th> <th>Qty</th> <th>UOM</th> </tr> </thead> <tbody> <tr> <td>0H2354A1</td> <td>XEVC-XEVL PLUS WASHING CIRCUIT PLAT</td> <td>1.000</td> <td>PC</td> </tr> <tr> <td>EL1450A0</td> <td>US SELF-CLEANING WATER SOLENOID</td> <td>4.000</td> <td>PC</td> </tr> <tr> <td>GN1526A0</td> <td>INT. D.=6.9 TH=1.8 O-RIN</td> <td>9.000</td> <td>PC</td> </tr> <tr> <td>RC1018A0</td> <td>ZINC PLATED D12 ELASTIC CLAMP</td> <td>3.000</td> <td>PC</td> </tr> <tr> <td>RC1019A0</td> <td>D=10 ELASTIC CLAMP</td> <td>2.000</td> <td>PC</td> </tr> </tbody> </table>	Code	Description	Qty	UOM	0H2354A1	XEVC-XEVL PLUS WASHING CIRCUIT PLAT	1.000	PC	EL1450A0	US SELF-CLEANING WATER SOLENOID	4.000	PC	GN1526A0	INT. D.=6.9 TH=1.8 O-RIN	9.000	PC	RC1018A0	ZINC PLATED D12 ELASTIC CLAMP	3.000	PC	RC1019A0	D=10 ELASTIC CLAMP	2.000	PC
			Code	Description	Qty	UOM																																																																														
VL1102A1	DETERGENT LINE FILTER + BARBED VNR 6 MM	1.000	PC																																																																																	
VL1127A1	6mm BARBED T-SHAPED FITTING	2.000	PC																																																																																	
VL1128A1	D6 BARBED CHECK VALVE	3.000	PC																																																																																	
VL1166A0	BB6-AR6 L FITTING	4.000	PC																																																																																	
VL1167A2	GN21 3 ROTOR ARMS B-B FLOW RESTRICTOR	1.000	PC																																																																																	
VL1174C0	D1.2 MM CALIBRATED D1.2 MM	1.000	PC																																																																																	
VL1185A0	2 WAYS PLUS WASHING DISTRIBUTOR	1.000	PC																																																																																	
VL1186A0	3 WAYS PLUS WASHING DISTRIBUTOR	1.000	PC																																																																																	
VL1190A0	PLUS WASHING SYSTEM INLET DISTRIBUTOR	1.000	PC																																																																																	
VL1214A0	BAYONET - 6mm BARBED NRV VALVE	1.000	PC																																																																																	
VM1605A0	CLIP TWIST LOCK DIAM. 10,2-12,7 MM	3.000	PC																																																																																	
VM2172A0	LOCKING CLIP FOR PUMP WITH CIRCUIT	9.000	PC																																																																																	
Code	Description	Qty	UOM																																																																																	
0H2354A1	XEVC-XEVL PLUS WASHING CIRCUIT PLAT	1.000	PC																																																																																	
EL1450A0	US SELF-CLEANING WATER SOLENOID	4.000	PC																																																																																	
GN1526A0	INT. D.=6.9 TH=1.8 O-RIN	9.000	PC																																																																																	
RC1018A0	ZINC PLATED D12 ELASTIC CLAMP	3.000	PC																																																																																	
RC1019A0	D=10 ELASTIC CLAMP	2.000	PC																																																																																	



COMPONENT			SPARE PART																																																																														
Code	Description	Image	Code	Description	Kit components																																																																												
VL1190A	PLUS WASHING SYSTEM INLET DISTRIBUTOR		KVL1208A	US PLUS 2 ROTOR ARMS WASHING SYSTEM KIT	<table border="1"> <thead> <tr> <th>Code</th> <th>Description</th> <th>Qty</th> <th>UOM</th> </tr> </thead> <tbody> <tr> <td>RC1130A0</td> <td>130x2,6 CLAM</td> <td>1.000</td> <td>PC</td> </tr> <tr> <td>RC1131A0</td> <td>200x2,6 BLACK CLAMP</td> <td>3.000</td> <td>PC</td> </tr> <tr> <td>RC1242A0</td> <td>D=10 CLOSED CAP</td> <td>2.000</td> <td>PC</td> </tr> <tr> <td>RC1356A0</td> <td>"STRAIGHT THREADED FEMALE END 8x1/4" BS</td> <td>1.000</td> <td>PC</td> </tr> <tr> <td>TB2821A0</td> <td>EPDM 6X10 L=40MM PIPE</td> <td>6.000</td> <td>PC</td> </tr> <tr> <td>TB2994A0</td> <td>HOOD DETERGENT PIPE</td> <td>1.000</td> <td>PC</td> </tr> <tr> <td>TB3004A0</td> <td>TB2820A L=550mm EPDM BLACK PIPE</td> <td>1.000</td> <td>PC</td> </tr> <tr> <td>TB3005B0</td> <td>TB3132A L=550mm EPDM WHITE-BLUE PIPE</td> <td>1.000</td> <td>PC</td> </tr> <tr> <td>TB3440A0</td> <td>TB3132A L=1050mm EPDM WHITE-BLUE PIPE</td> <td>1.000</td> <td>PC</td> </tr> <tr> <td>VL1019A0</td> <td>VIBRATION DETERGENT PUMP</td> <td>1.000</td> <td>PC</td> </tr> <tr> <td>VL1047A1</td> <td>D6 PIPE HOLDER - D8 J.G. TERMINAL</td> <td>1.000</td> <td>PC</td> </tr> <tr> <td>VL1065A1</td> <td>1/4 MALE N.O. PRESSURE SWITCH</td> <td>1.000</td> <td>PC</td> </tr> <tr> <td>VL1102A1</td> <td>DETERGENT LINE FILTER + BARBED VNR 6 MM</td> <td>1.000</td> <td>PC</td> </tr> <tr> <td>VL1128A1</td> <td>D6 BARBED CHECK VALVE</td> <td>2.000</td> <td>PC</td> </tr> <tr> <td>VL1141A1</td> <td>BB6-BB6 STRAIGHT CONNECTION</td> <td>1.000</td> <td>PC</td> </tr> <tr> <td>VL1166A0</td> <td>BB6-AR6 L FITTING</td> <td>4.000</td> <td>PC</td> </tr> <tr> <td>VL1174C0</td> <td>D1.2 MM CALIBRATED D1.2 MM</td> <td>1.000</td> <td>PC</td> </tr> <tr> <td>VL1186A0</td> <td>3 WAYS PLUS WASHING DISTRIBUTOR</td> <td>1.000</td> <td>PC</td> </tr> </tbody> </table>	Code	Description	Qty	UOM	RC1130A0	130x2,6 CLAM	1.000	PC	RC1131A0	200x2,6 BLACK CLAMP	3.000	PC	RC1242A0	D=10 CLOSED CAP	2.000	PC	RC1356A0	"STRAIGHT THREADED FEMALE END 8x1/4" BS	1.000	PC	TB2821A0	EPDM 6X10 L=40MM PIPE	6.000	PC	TB2994A0	HOOD DETERGENT PIPE	1.000	PC	TB3004A0	TB2820A L=550mm EPDM BLACK PIPE	1.000	PC	TB3005B0	TB3132A L=550mm EPDM WHITE-BLUE PIPE	1.000	PC	TB3440A0	TB3132A L=1050mm EPDM WHITE-BLUE PIPE	1.000	PC	VL1019A0	VIBRATION DETERGENT PUMP	1.000	PC	VL1047A1	D6 PIPE HOLDER - D8 J.G. TERMINAL	1.000	PC	VL1065A1	1/4 MALE N.O. PRESSURE SWITCH	1.000	PC	VL1102A1	DETERGENT LINE FILTER + BARBED VNR 6 MM	1.000	PC	VL1128A1	D6 BARBED CHECK VALVE	2.000	PC	VL1141A1	BB6-BB6 STRAIGHT CONNECTION	1.000	PC	VL1166A0	BB6-AR6 L FITTING	4.000	PC	VL1174C0	D1.2 MM CALIBRATED D1.2 MM	1.000	PC	VL1186A0	3 WAYS PLUS WASHING DISTRIBUTOR	1.000	PC
					Code	Description	Qty	UOM																																																																									
					RC1130A0	130x2,6 CLAM	1.000	PC																																																																									
					RC1131A0	200x2,6 BLACK CLAMP	3.000	PC																																																																									
					RC1242A0	D=10 CLOSED CAP	2.000	PC																																																																									
					RC1356A0	"STRAIGHT THREADED FEMALE END 8x1/4" BS	1.000	PC																																																																									
					TB2821A0	EPDM 6X10 L=40MM PIPE	6.000	PC																																																																									
					TB2994A0	HOOD DETERGENT PIPE	1.000	PC																																																																									
					TB3004A0	TB2820A L=550mm EPDM BLACK PIPE	1.000	PC																																																																									
					TB3005B0	TB3132A L=550mm EPDM WHITE-BLUE PIPE	1.000	PC																																																																									
					TB3440A0	TB3132A L=1050mm EPDM WHITE-BLUE PIPE	1.000	PC																																																																									
					VL1019A0	VIBRATION DETERGENT PUMP	1.000	PC																																																																									
					VL1047A1	D6 PIPE HOLDER - D8 J.G. TERMINAL	1.000	PC																																																																									
					VL1065A1	1/4 MALE N.O. PRESSURE SWITCH	1.000	PC																																																																									
					VL1102A1	DETERGENT LINE FILTER + BARBED VNR 6 MM	1.000	PC																																																																									
					VL1128A1	D6 BARBED CHECK VALVE	2.000	PC																																																																									
					VL1141A1	BB6-BB6 STRAIGHT CONNECTION	1.000	PC																																																																									
					VL1166A0	BB6-AR6 L FITTING	4.000	PC																																																																									
					VL1174C0	D1.2 MM CALIBRATED D1.2 MM	1.000	PC																																																																									
					VL1186A0	3 WAYS PLUS WASHING DISTRIBUTOR	1.000	PC																																																																									



COMPONENT			SPARE PART																																																											
Code	Description	Image	Code	Description	Kit components																																																									
VL1190A	PLUS WASHING SYSTEM INLET DISTRIBUTOR		KVL1208A	US PLUS 2 ROTOR ARMS WASHING SYSTEM KIT	<table border="1"> <thead> <tr> <th>Code</th> <th>Description</th> <th>Qty</th> <th>UOM</th> </tr> </thead> <tbody> <tr> <td>VL1190A0</td> <td>PLUS WASHING SYSTEM INLET DISTRIBUTOR</td> <td>1.000</td> <td>PC</td> </tr> <tr> <td>VL1214A0</td> <td>BAYONET - 6mm BARBED NRV VALVE</td> <td>1.000</td> <td>PC</td> </tr> <tr> <td>VM1605A0</td> <td>CLIP TWIST LOCK DIAM. 10,2-12,7 MM</td> <td>3.000</td> <td>PC</td> </tr> <tr> <td>VM2172A0</td> <td>LOCKING CLIP FOR PUMP WITH CIRCUIT</td> <td>5.000</td> <td>PC</td> </tr> </tbody> </table>	Code	Description	Qty	UOM	VL1190A0	PLUS WASHING SYSTEM INLET DISTRIBUTOR	1.000	PC	VL1214A0	BAYONET - 6mm BARBED NRV VALVE	1.000	PC	VM1605A0	CLIP TWIST LOCK DIAM. 10,2-12,7 MM	3.000	PC	VM2172A0	LOCKING CLIP FOR PUMP WITH CIRCUIT	5.000	PC																																					
			Code	Description	Qty	UOM																																																								
VL1190A0	PLUS WASHING SYSTEM INLET DISTRIBUTOR	1.000	PC																																																											
VL1214A0	BAYONET - 6mm BARBED NRV VALVE	1.000	PC																																																											
VM1605A0	CLIP TWIST LOCK DIAM. 10,2-12,7 MM	3.000	PC																																																											
VM2172A0	LOCKING CLIP FOR PUMP WITH CIRCUIT	5.000	PC																																																											
KVL1207A	US PLUS 1 ROTOR ARM WASHING SYSTEM KIT	<table border="1"> <thead> <tr> <th>Code</th> <th>Description</th> <th>Qty</th> <th>UOM</th> </tr> </thead> <tbody> <tr> <td>0H2354A1</td> <td>XEVC-XEVL PLUS WASHING CIRCUIT PLAT</td> <td>1.000</td> <td>PC</td> </tr> <tr> <td>EL1450A0</td> <td>US SELF-CLEANING WATER SOLENOID</td> <td>3.000</td> <td>PC</td> </tr> <tr> <td>GN1526A0</td> <td>INT. D.=6.9 TH=1.8 O-RING</td> <td>7.000</td> <td>PC</td> </tr> <tr> <td>RC1018A0</td> <td>ZINC PLATED D12 ELASTIC CLAMP</td> <td>2.000</td> <td>PC</td> </tr> <tr> <td>RC1019A0</td> <td>D=10 ELASTIC CLAMP</td> <td>14.000</td> <td>PC</td> </tr> <tr> <td>RC1130A0</td> <td>130x2,6 CLAMP</td> <td>1.000</td> <td>PC</td> </tr> <tr> <td>RC1131A0</td> <td>200x2,6 BLACK CLAMP</td> <td>2.000</td> <td>PC</td> </tr> <tr> <td>RC1242A0</td> <td>D=10 CLOSED CAP</td> <td>2.000</td> <td>PC</td> </tr> <tr> <td>RC1356A0</td> <td>"STRAIGHT THREADED FEMALE END 8x1/4" BS</td> <td>1.000</td> <td>PC</td> </tr> <tr> <td>TB2821A0</td> <td>EPDM 6X10 L=40MM PIPE</td> <td>6.000</td> <td>PC</td> </tr> <tr> <td>TB3004A0</td> <td>TB2820A L=550mm EPDM BLACK PIPE</td> <td>1.000</td> <td>PC</td> </tr> <tr> <td>TB3005B0</td> <td>TB3132A L=550mm EPDM WHITE-BLUE PIPE</td> <td>1.000</td> <td>PC</td> </tr> <tr> <td>TB3225B0</td> <td>TB2820A-TAN K-WASHING SYS CONNECTION</td> <td>1.000</td> <td>PC</td> </tr> <tr> <td>TB3252A0</td> <td>TB3252A0</td> <td>1.000</td> <td>PC</td> </tr> </tbody> </table>	Code	Description	Qty	UOM	0H2354A1	XEVC-XEVL PLUS WASHING CIRCUIT PLAT	1.000	PC	EL1450A0	US SELF-CLEANING WATER SOLENOID	3.000	PC	GN1526A0	INT. D.=6.9 TH=1.8 O-RING	7.000	PC	RC1018A0	ZINC PLATED D12 ELASTIC CLAMP	2.000	PC	RC1019A0	D=10 ELASTIC CLAMP	14.000	PC	RC1130A0	130x2,6 CLAMP	1.000	PC	RC1131A0	200x2,6 BLACK CLAMP	2.000	PC	RC1242A0	D=10 CLOSED CAP	2.000	PC	RC1356A0	"STRAIGHT THREADED FEMALE END 8x1/4" BS	1.000	PC	TB2821A0	EPDM 6X10 L=40MM PIPE	6.000	PC	TB3004A0	TB2820A L=550mm EPDM BLACK PIPE	1.000	PC	TB3005B0	TB3132A L=550mm EPDM WHITE-BLUE PIPE	1.000	PC	TB3225B0	TB2820A-TAN K-WASHING SYS CONNECTION	1.000	PC	TB3252A0	TB3252A0	1.000	PC
Code	Description	Qty	UOM																																																											
0H2354A1	XEVC-XEVL PLUS WASHING CIRCUIT PLAT	1.000	PC																																																											
EL1450A0	US SELF-CLEANING WATER SOLENOID	3.000	PC																																																											
GN1526A0	INT. D.=6.9 TH=1.8 O-RING	7.000	PC																																																											
RC1018A0	ZINC PLATED D12 ELASTIC CLAMP	2.000	PC																																																											
RC1019A0	D=10 ELASTIC CLAMP	14.000	PC																																																											
RC1130A0	130x2,6 CLAMP	1.000	PC																																																											
RC1131A0	200x2,6 BLACK CLAMP	2.000	PC																																																											
RC1242A0	D=10 CLOSED CAP	2.000	PC																																																											
RC1356A0	"STRAIGHT THREADED FEMALE END 8x1/4" BS	1.000	PC																																																											
TB2821A0	EPDM 6X10 L=40MM PIPE	6.000	PC																																																											
TB3004A0	TB2820A L=550mm EPDM BLACK PIPE	1.000	PC																																																											
TB3005B0	TB3132A L=550mm EPDM WHITE-BLUE PIPE	1.000	PC																																																											
TB3225B0	TB2820A-TAN K-WASHING SYS CONNECTION	1.000	PC																																																											
TB3252A0	TB3252A0	1.000	PC																																																											



COMPONENT			SPARE PART																																																																																					
Code	Description	Image	Code	Description	Kit components																																																																																			
VL1190A	PLUS WASHING SYSTEM INLET DISTRIBUTOR		KVL1207A	US PLUS 1 ROTOR ARM WASHING SYSTEM KIT	<table border="1"> <thead> <tr> <th>Code</th> <th>Description</th> <th>Qty</th> <th>UOM</th> </tr> </thead> <tbody> <tr> <td>VL1019A0</td> <td>VIBRATION DETERGENT PUMP</td> <td>1.000</td> <td>PC</td> </tr> <tr> <td>VL1047A1</td> <td>D6 PIPE HOLDER - D8 J.G. TERMINAL</td> <td>1.000</td> <td>PC</td> </tr> <tr> <td>VL1065A1</td> <td>1/4 MALE N.O. PRESSURE SWITCH</td> <td>1.000</td> <td>PC</td> </tr> <tr> <td>VL1102A1</td> <td>DETERGENT LINE FILTER + BARBED VNR 6 MM</td> <td>1.000</td> <td>PC</td> </tr> <tr> <td>VL1128A1</td> <td>D6 BARBED CHECK VALVE</td> <td>2.000</td> <td>PC</td> </tr> <tr> <td>VL1166A0</td> <td>BB6-AR6 L FITTING</td> <td>3.000</td> <td>PC</td> </tr> <tr> <td>VL1174C0</td> <td>D1.2 MM CALIBRATED D1.2 MM</td> <td>1.000</td> <td>PC</td> </tr> <tr> <td>VL1185A0</td> <td>2 WAYS PLUS WASHING DISTRIBUTOR</td> <td>1.000</td> <td>PC</td> </tr> <tr> <td>VL1190A0</td> <td>PLUS WASHING SYSTEM INLET DISTRIBUTOR</td> <td>1.000</td> <td>PC</td> </tr> <tr> <td>VL1214A0</td> <td>BAYONET - 6mm BARBED NRV VALVE</td> <td>1.000</td> <td>PC</td> </tr> <tr> <td>VM1605A0</td> <td>CLIP TWIST LOCK DIAM. 10,2-12,7 MM</td> <td>3.000</td> <td>PC</td> </tr> <tr> <td>VM2172A0</td> <td>LOCKING CLIP FOR PUMP WITH CIRCUIT</td> <td>3.000</td> <td>PC</td> </tr> </tbody> </table>	Code	Description	Qty	UOM	VL1019A0	VIBRATION DETERGENT PUMP	1.000	PC	VL1047A1	D6 PIPE HOLDER - D8 J.G. TERMINAL	1.000	PC	VL1065A1	1/4 MALE N.O. PRESSURE SWITCH	1.000	PC	VL1102A1	DETERGENT LINE FILTER + BARBED VNR 6 MM	1.000	PC	VL1128A1	D6 BARBED CHECK VALVE	2.000	PC	VL1166A0	BB6-AR6 L FITTING	3.000	PC	VL1174C0	D1.2 MM CALIBRATED D1.2 MM	1.000	PC	VL1185A0	2 WAYS PLUS WASHING DISTRIBUTOR	1.000	PC	VL1190A0	PLUS WASHING SYSTEM INLET DISTRIBUTOR	1.000	PC	VL1214A0	BAYONET - 6mm BARBED NRV VALVE	1.000	PC	VM1605A0	CLIP TWIST LOCK DIAM. 10,2-12,7 MM	3.000	PC	VM2172A0	LOCKING CLIP FOR PUMP WITH CIRCUIT	3.000	PC	KVL1187A	3 ROTOR ARMS PLUS EU CLEANING SYSTEM KIT	<table border="1"> <thead> <tr> <th>Code</th> <th>Description</th> <th>Qty</th> <th>UOM</th> </tr> </thead> <tbody> <tr> <td>0H2354A1</td> <td>XEVC-XEVL PLUS WASHING CIRCUIT PLAT</td> <td>1.000</td> <td>PC</td> </tr> <tr> <td>EL1440A0</td> <td>WATER SELF CLEANING VALVE</td> <td>4.000</td> <td>PC</td> </tr> <tr> <td>GN1526A0</td> <td>INT. D.=6.9 TH=1.8 O-RIN</td> <td>9.000</td> <td>PC</td> </tr> <tr> <td>RC1018A0</td> <td>ZINC PLATED D12 ELASTIC CLAMP</td> <td>11.000</td> <td>PC</td> </tr> <tr> <td>RC1019A0</td> <td>D=10 ELASTIC CLAMP</td> <td>16.000</td> <td>PC</td> </tr> <tr> <td>RC1130A0</td> <td>130x2,6 CLAM</td> <td>1.000</td> <td>PC</td> </tr> </tbody> </table>	Code	Description	Qty	UOM	0H2354A1	XEVC-XEVL PLUS WASHING CIRCUIT PLAT	1.000	PC	EL1440A0	WATER SELF CLEANING VALVE	4.000	PC	GN1526A0	INT. D.=6.9 TH=1.8 O-RIN	9.000	PC	RC1018A0	ZINC PLATED D12 ELASTIC CLAMP	11.000	PC	RC1019A0	D=10 ELASTIC CLAMP	16.000	PC	RC1130A0	130x2,6 CLAM	1.000	PC
			Code	Description	Qty	UOM																																																																																		
VL1019A0	VIBRATION DETERGENT PUMP	1.000	PC																																																																																					
VL1047A1	D6 PIPE HOLDER - D8 J.G. TERMINAL	1.000	PC																																																																																					
VL1065A1	1/4 MALE N.O. PRESSURE SWITCH	1.000	PC																																																																																					
VL1102A1	DETERGENT LINE FILTER + BARBED VNR 6 MM	1.000	PC																																																																																					
VL1128A1	D6 BARBED CHECK VALVE	2.000	PC																																																																																					
VL1166A0	BB6-AR6 L FITTING	3.000	PC																																																																																					
VL1174C0	D1.2 MM CALIBRATED D1.2 MM	1.000	PC																																																																																					
VL1185A0	2 WAYS PLUS WASHING DISTRIBUTOR	1.000	PC																																																																																					
VL1190A0	PLUS WASHING SYSTEM INLET DISTRIBUTOR	1.000	PC																																																																																					
VL1214A0	BAYONET - 6mm BARBED NRV VALVE	1.000	PC																																																																																					
VM1605A0	CLIP TWIST LOCK DIAM. 10,2-12,7 MM	3.000	PC																																																																																					
VM2172A0	LOCKING CLIP FOR PUMP WITH CIRCUIT	3.000	PC																																																																																					
Code	Description	Qty	UOM																																																																																					
0H2354A1	XEVC-XEVL PLUS WASHING CIRCUIT PLAT	1.000	PC																																																																																					
EL1440A0	WATER SELF CLEANING VALVE	4.000	PC																																																																																					
GN1526A0	INT. D.=6.9 TH=1.8 O-RIN	9.000	PC																																																																																					
RC1018A0	ZINC PLATED D12 ELASTIC CLAMP	11.000	PC																																																																																					
RC1019A0	D=10 ELASTIC CLAMP	16.000	PC																																																																																					
RC1130A0	130x2,6 CLAM	1.000	PC																																																																																					



COMPONENT			SPARE PART					
Code	Description	Image	Code	Description	Kit components			
VL1190A	PLUS WASHING SYSTEM INLET DISTRIBUTOR		KVL1187A	3 ROTOR ARMS PLUS EU CLEANING SYSTEM KIT	Code	Description	Qty	UOM
					RC1131A0	200x2.6 BLACK CLAMP	3.000	PC
					RC1242A0	D=10 CLOSED CAP	2.000	PC
					RC1356A0	"STRAIGHT THREADED FEMALE END 8x1/4" BS	1.000	PC
					TB2652A0		1.000	PC
					TB2677A0		1.000	PC
					TB2821A0	EPDM 6X10 L=40MM PIPE	6.000	PC
					TB3004A0	TB2820A L=550mm EPDM BLACK PIPE	2.000	PC
					TB3024C0		3.000	PC
					TB3226A0		1.000	PC
					TB3440A0	TB3132A L=1050mm EPDM WHITE-BLUE PIPE	1.000	PC
					VL1019A0	VIBRATION DETERGENT PUMP	1.000	PC
					VL1047A1	D6 PIPE HOLDER - D8 J.G. TERMINAL	1.000	PC
					VL1065A1	1/4 MALE N.O. PRESSURE SWITCH	1.000	PC
					VL1102A1	DETERGENT LINE FILTER + BARBED VNR 6 MM	1.000	PC
					VL1127A1	6mm BARBED T-SHAPED FITTING	2.000	PC
					VL1128A1	D6 BARBED CHECK VALVE	3.000	PC
					VL1166A0	BB6-AR6 L FITTING	4.000	PC
					VL1167A2	GN21 3 ROTOR ARMS B-B FLOW RESTRICTOR	1.000	PC
					VL1174C0	D1.2 MM CALIBRATED D1.2 MM	1.000	PC
VL1186A0	3 WAYS PLUS WASHING DISTRIBUTOR	1.000	PC					



COMPONENT			SPARE PART																																																							
Code	Description	Image	Code	Description	Kit components																																																					
VL1190A	PLUS WASHING SYSTEM INLET DISTRIBUTOR		KVL1187A	3 ROTOR ARMS PLUS EU CLEANING SYSTEM KIT	<table border="1"> <thead> <tr> <th>Code</th> <th>Description</th> <th>Qty</th> <th>UOM</th> </tr> </thead> <tbody> <tr> <td>VL1190A0</td> <td>PLUS WASHING SYSTEM INLET DISTRIBUTOR</td> <td>1.000</td> <td>PC</td> </tr> <tr> <td>VL1214A0</td> <td>BAYONET - 6mm BARBED NRV VALVE</td> <td>1.000</td> <td>PC</td> </tr> <tr> <td>VM1605A0</td> <td>CLIP TWIST LOCK DIAM. 10,2-12,7 MM</td> <td>3.000</td> <td>PC</td> </tr> <tr> <td>VM2172A0</td> <td>LOCKING CLIP FOR PUMP WITH CIRCUIT</td> <td>5.000</td> <td>PC</td> </tr> </tbody> </table>	Code	Description	Qty	UOM	VL1190A0	PLUS WASHING SYSTEM INLET DISTRIBUTOR	1.000	PC	VL1214A0	BAYONET - 6mm BARBED NRV VALVE	1.000	PC	VM1605A0	CLIP TWIST LOCK DIAM. 10,2-12,7 MM	3.000	PC	VM2172A0	LOCKING CLIP FOR PUMP WITH CIRCUIT	5.000	PC																																	
			Code	Description	Qty	UOM																																																				
VL1190A0	PLUS WASHING SYSTEM INLET DISTRIBUTOR	1.000	PC																																																							
VL1214A0	BAYONET - 6mm BARBED NRV VALVE	1.000	PC																																																							
VM1605A0	CLIP TWIST LOCK DIAM. 10,2-12,7 MM	3.000	PC																																																							
VM2172A0	LOCKING CLIP FOR PUMP WITH CIRCUIT	5.000	PC																																																							
KVL1184A	2 ROTOR ARMS PLUS EU CLEANING SYSTEM KIT	<table border="1"> <thead> <tr> <th>Code</th> <th>Description</th> <th>Qty</th> <th>UOM</th> </tr> </thead> <tbody> <tr> <td>0H2354A1</td> <td>XEVC-XEVL PLUS WASHING CIRCUIT PLAT</td> <td>1.000</td> <td>PC</td> </tr> <tr> <td>EL1440A0</td> <td>WATER SELF CLEANING VALVE</td> <td>4.000</td> <td>PC</td> </tr> <tr> <td>GN1526A0</td> <td>INT. D.=6.9 TH=1.8 O-RIN</td> <td>9.000</td> <td>PC</td> </tr> <tr> <td>RC1018A0</td> <td>ZINC PLATED D12 ELASTIC CLAMP</td> <td>3.000</td> <td>PC</td> </tr> <tr> <td>RC1019A0</td> <td>D=10 ELASTIC CLAMP</td> <td>15.000</td> <td>PC</td> </tr> <tr> <td>RC1130A0</td> <td>130x2.6 CLAM</td> <td>1.000</td> <td>PC</td> </tr> <tr> <td>RC1131A0</td> <td>200x2.6 BLACK CLAMP</td> <td>3.000</td> <td>PC</td> </tr> <tr> <td>RC1242A0</td> <td>D=10 CLOSED CAP</td> <td>2.000</td> <td>PC</td> </tr> <tr> <td>RC1356A0</td> <td>"STRAIGHT THREADED FEMALE END 8x1/4" BS</td> <td>1.000</td> <td>PC</td> </tr> <tr> <td>TB2821A0</td> <td>EPDM 6X10 L=40MM PIPE</td> <td>6.000</td> <td>PC</td> </tr> <tr> <td>TB2994A0</td> <td>HOOD DETERGENT PIPE</td> <td>1.000</td> <td>PC</td> </tr> <tr> <td>TB3004A0</td> <td>TB2820A L=550mm EPDM BLACK PIPE</td> <td>2.000</td> <td>PC</td> </tr> <tr> <td>TB3005B0</td> <td>TB3132A L=550mm EPDM WHITE-BLUE PIPE</td> <td>1.000</td> <td>PC</td> </tr> </tbody> </table>	Code	Description	Qty	UOM	0H2354A1	XEVC-XEVL PLUS WASHING CIRCUIT PLAT	1.000	PC	EL1440A0	WATER SELF CLEANING VALVE	4.000	PC	GN1526A0	INT. D.=6.9 TH=1.8 O-RIN	9.000	PC	RC1018A0	ZINC PLATED D12 ELASTIC CLAMP	3.000	PC	RC1019A0	D=10 ELASTIC CLAMP	15.000	PC	RC1130A0	130x2.6 CLAM	1.000	PC	RC1131A0	200x2.6 BLACK CLAMP	3.000	PC	RC1242A0	D=10 CLOSED CAP	2.000	PC	RC1356A0	"STRAIGHT THREADED FEMALE END 8x1/4" BS	1.000	PC	TB2821A0	EPDM 6X10 L=40MM PIPE	6.000	PC	TB2994A0	HOOD DETERGENT PIPE	1.000	PC	TB3004A0	TB2820A L=550mm EPDM BLACK PIPE	2.000	PC	TB3005B0	TB3132A L=550mm EPDM WHITE-BLUE PIPE	1.000	PC
Code	Description	Qty	UOM																																																							
0H2354A1	XEVC-XEVL PLUS WASHING CIRCUIT PLAT	1.000	PC																																																							
EL1440A0	WATER SELF CLEANING VALVE	4.000	PC																																																							
GN1526A0	INT. D.=6.9 TH=1.8 O-RIN	9.000	PC																																																							
RC1018A0	ZINC PLATED D12 ELASTIC CLAMP	3.000	PC																																																							
RC1019A0	D=10 ELASTIC CLAMP	15.000	PC																																																							
RC1130A0	130x2.6 CLAM	1.000	PC																																																							
RC1131A0	200x2.6 BLACK CLAMP	3.000	PC																																																							
RC1242A0	D=10 CLOSED CAP	2.000	PC																																																							
RC1356A0	"STRAIGHT THREADED FEMALE END 8x1/4" BS	1.000	PC																																																							
TB2821A0	EPDM 6X10 L=40MM PIPE	6.000	PC																																																							
TB2994A0	HOOD DETERGENT PIPE	1.000	PC																																																							
TB3004A0	TB2820A L=550mm EPDM BLACK PIPE	2.000	PC																																																							
TB3005B0	TB3132A L=550mm EPDM WHITE-BLUE PIPE	1.000	PC																																																							



COMPONENT			SPARE PART																																																																													
Code	Description	Image	Code	Description	Kit components																																																																											
VL1190A	PLUS WASHING SYSTEM INLET DISTRIBUTOR		KVL1184A	2 ROTOR ARMS PLUS EU CLEANING SYSTEM KIT	<table border="1"> <thead> <tr> <th>Code</th> <th>Description</th> <th>Qty</th> <th>UOM</th> </tr> </thead> <tbody> <tr> <td>TB3440A0</td> <td>TB3132A L=1050mm EPDM WHITE-BLUE PIPE</td> <td>1.000</td> <td>PC</td> </tr> <tr> <td>VL1019A0</td> <td>VIBRATION DETERGENT PUMP</td> <td>1.000</td> <td>PC</td> </tr> <tr> <td>VL1047A1</td> <td>D6 PIPE HOLDER - D8 J.G. TERMINAL</td> <td>1.000</td> <td>PC</td> </tr> <tr> <td>VL1065A1</td> <td>1/4 MALE N.O. PRESSURE SWITCH</td> <td>1.000</td> <td>PC</td> </tr> <tr> <td>VL1102A1</td> <td>DETERGENT LINE FILTER + BARBED VNR 6 MM</td> <td>1.000</td> <td>PC</td> </tr> <tr> <td>VL1128A1</td> <td>D6 BARBED CHECK VALVE</td> <td>2.000</td> <td>PC</td> </tr> <tr> <td>VL1141A1</td> <td>BB6-BB6 STRAIGHT CONNECTION</td> <td>1.000</td> <td>PC</td> </tr> <tr> <td>VL1166A0</td> <td>BB6-AR6 L FITTING</td> <td>4.000</td> <td>PC</td> </tr> <tr> <td>VL1174C0</td> <td>D1.2 MM CALIBRATED D1.2 MM</td> <td>1.000</td> <td>PC</td> </tr> <tr> <td>VL1186A0</td> <td>3 WAYS PLUS WASHING DISTRIBUTOR</td> <td>1.000</td> <td>PC</td> </tr> <tr> <td>VL1190A0</td> <td>PLUS WASHING SYSTEM INLET DISTRIBUTOR</td> <td>1.000</td> <td>PC</td> </tr> <tr> <td>VL1214A0</td> <td>BAYONET - 6mm BARBED NRV VALVE</td> <td>1.000</td> <td>PC</td> </tr> <tr> <td>VM1605A0</td> <td>CLIP TWIST LOCK DIAM. 10.2-12.7 MM</td> <td>3.000</td> <td>PC</td> </tr> <tr> <td>VM2172A0</td> <td>LOCKING CLIP FOR PUMP WITH CIRCUIT</td> <td>5.000</td> <td>PC</td> </tr> </tbody> </table>	Code	Description	Qty	UOM	TB3440A0	TB3132A L=1050mm EPDM WHITE-BLUE PIPE	1.000	PC	VL1019A0	VIBRATION DETERGENT PUMP	1.000	PC	VL1047A1	D6 PIPE HOLDER - D8 J.G. TERMINAL	1.000	PC	VL1065A1	1/4 MALE N.O. PRESSURE SWITCH	1.000	PC	VL1102A1	DETERGENT LINE FILTER + BARBED VNR 6 MM	1.000	PC	VL1128A1	D6 BARBED CHECK VALVE	2.000	PC	VL1141A1	BB6-BB6 STRAIGHT CONNECTION	1.000	PC	VL1166A0	BB6-AR6 L FITTING	4.000	PC	VL1174C0	D1.2 MM CALIBRATED D1.2 MM	1.000	PC	VL1186A0	3 WAYS PLUS WASHING DISTRIBUTOR	1.000	PC	VL1190A0	PLUS WASHING SYSTEM INLET DISTRIBUTOR	1.000	PC	VL1214A0	BAYONET - 6mm BARBED NRV VALVE	1.000	PC	VM1605A0	CLIP TWIST LOCK DIAM. 10.2-12.7 MM	3.000	PC	VM2172A0	LOCKING CLIP FOR PUMP WITH CIRCUIT	5.000	PC	KVL1183A	1 ROTOR ARM PLUS CLEANING SYSTEM KIT	<table border="1"> <thead> <tr> <th>Code</th> <th>Description</th> <th>Qty</th> <th>UOM</th> </tr> </thead> <tbody> <tr> <td>0H2354A1</td> <td>XEVC-XEVL PLUS WASHING CIRCUIT PLAT</td> <td>1.000</td> <td>PC</td> </tr> <tr> <td>EL1440A0</td> <td>WATER SELF CLEANING VALVE</td> <td>3.000</td> <td>PC</td> </tr> </tbody> </table>	Code	Description	Qty	UOM	0H2354A1	XEVC-XEVL PLUS WASHING CIRCUIT PLAT	1.000	PC	EL1440A0	WATER SELF CLEANING VALVE	3.000	PC
			Code	Description	Qty	UOM																																																																										
TB3440A0	TB3132A L=1050mm EPDM WHITE-BLUE PIPE	1.000	PC																																																																													
VL1019A0	VIBRATION DETERGENT PUMP	1.000	PC																																																																													
VL1047A1	D6 PIPE HOLDER - D8 J.G. TERMINAL	1.000	PC																																																																													
VL1065A1	1/4 MALE N.O. PRESSURE SWITCH	1.000	PC																																																																													
VL1102A1	DETERGENT LINE FILTER + BARBED VNR 6 MM	1.000	PC																																																																													
VL1128A1	D6 BARBED CHECK VALVE	2.000	PC																																																																													
VL1141A1	BB6-BB6 STRAIGHT CONNECTION	1.000	PC																																																																													
VL1166A0	BB6-AR6 L FITTING	4.000	PC																																																																													
VL1174C0	D1.2 MM CALIBRATED D1.2 MM	1.000	PC																																																																													
VL1186A0	3 WAYS PLUS WASHING DISTRIBUTOR	1.000	PC																																																																													
VL1190A0	PLUS WASHING SYSTEM INLET DISTRIBUTOR	1.000	PC																																																																													
VL1214A0	BAYONET - 6mm BARBED NRV VALVE	1.000	PC																																																																													
VM1605A0	CLIP TWIST LOCK DIAM. 10.2-12.7 MM	3.000	PC																																																																													
VM2172A0	LOCKING CLIP FOR PUMP WITH CIRCUIT	5.000	PC																																																																													
Code	Description	Qty	UOM																																																																													
0H2354A1	XEVC-XEVL PLUS WASHING CIRCUIT PLAT	1.000	PC																																																																													
EL1440A0	WATER SELF CLEANING VALVE	3.000	PC																																																																													





COMPONENT			SPARE PART																																																																																						
Code	Description	Image	Code	Description	Kit components																																																																																				
VL1190A	PLUS WASHING SYSTEM INLET DISTRIBUTOR		KVL1183A	1 ROTOR ARM PLUS CLEANING SYSTEM KIT	<table border="1"> <thead> <tr> <th>Code</th> <th>Description</th> <th>Qty</th> <th>UOM</th> </tr> </thead> <tbody> <tr> <td>GN1526A0</td> <td>INT. D.=6.9 TH=1.8 O-RIN</td> <td>7.000</td> <td>PC</td> </tr> <tr> <td>RC1018A0</td> <td>ZINC PLATED D12 ELASTIC CLAMP</td> <td>2.000</td> <td>PC</td> </tr> <tr> <td>RC1019A0</td> <td>D=10 ELASTIC CLAMP</td> <td>14.000</td> <td>PC</td> </tr> <tr> <td>RC1130A0</td> <td>130x2.6 CLAM</td> <td>1.000</td> <td>PC</td> </tr> <tr> <td>RC1131A0</td> <td>200x2.6 BLACK CLAMP</td> <td>2.000</td> <td>PC</td> </tr> <tr> <td>RC1242A0</td> <td>D=10 CLOSED CAP</td> <td>2.000</td> <td>PC</td> </tr> <tr> <td>RC1356A0</td> <td>"STRAIGHT THREADED FEMALE END 8x1/4" BS</td> <td>1.000</td> <td>PC</td> </tr> <tr> <td>TB2821A0</td> <td>EPDM 6X10 L=40MM PIPE</td> <td>6.000</td> <td>PC</td> </tr> <tr> <td>TB3004A0</td> <td>TB2820A L=550mm EPDM BLACK PIPE</td> <td>1.000</td> <td>PC</td> </tr> <tr> <td>TB3005B0</td> <td>TB3132A L=550mm EPDM WHITE-BLUE PIPE</td> <td>1.000</td> <td>PC</td> </tr> <tr> <td>TB3225B0</td> <td>TB2820A-TAN K-WASHYNG SYS CONNECTION</td> <td>1.000</td> <td>PC</td> </tr> <tr> <td>TB3252A0</td> <td>TB3252A0</td> <td>1.000</td> <td>PC</td> </tr> <tr> <td>VL1019A0</td> <td>VIBRATION DETERGENT PUMP</td> <td>1.000</td> <td>PC</td> </tr> <tr> <td>VL1047A1</td> <td>D6 PIPE HOLDER - D6 J.G. TERMINAL</td> <td>1.000</td> <td>PC</td> </tr> <tr> <td>VL1065A1</td> <td>1/4 MALE N.O. PRESSURE SWITCH</td> <td>1.000</td> <td>PC</td> </tr> <tr> <td>VL1102A1</td> <td>DETERGENT LINE FILTER + BARBED VNR 6 MM</td> <td>1.000</td> <td>PC</td> </tr> <tr> <td>VL1128A1</td> <td>D6 BARBED CHECK VALVE</td> <td>2.000</td> <td>PC</td> </tr> <tr> <td>VL1166A0</td> <td>BB6-AR6 L FITTING</td> <td>3.000</td> <td>PC</td> </tr> <tr> <td>VL1174C0</td> <td>D1.2 MM CALIBRATED D1.2 MM</td> <td>1.000</td> <td>PC</td> </tr> <tr> <td>VL1185A0</td> <td>2 WAYS PLUS WASHING DISTRIBUTOR</td> <td>1.000</td> <td>PC</td> </tr> </tbody> </table>	Code	Description	Qty	UOM	GN1526A0	INT. D.=6.9 TH=1.8 O-RIN	7.000	PC	RC1018A0	ZINC PLATED D12 ELASTIC CLAMP	2.000	PC	RC1019A0	D=10 ELASTIC CLAMP	14.000	PC	RC1130A0	130x2.6 CLAM	1.000	PC	RC1131A0	200x2.6 BLACK CLAMP	2.000	PC	RC1242A0	D=10 CLOSED CAP	2.000	PC	RC1356A0	"STRAIGHT THREADED FEMALE END 8x1/4" BS	1.000	PC	TB2821A0	EPDM 6X10 L=40MM PIPE	6.000	PC	TB3004A0	TB2820A L=550mm EPDM BLACK PIPE	1.000	PC	TB3005B0	TB3132A L=550mm EPDM WHITE-BLUE PIPE	1.000	PC	TB3225B0	TB2820A-TAN K-WASHYNG SYS CONNECTION	1.000	PC	TB3252A0	TB3252A0	1.000	PC	VL1019A0	VIBRATION DETERGENT PUMP	1.000	PC	VL1047A1	D6 PIPE HOLDER - D6 J.G. TERMINAL	1.000	PC	VL1065A1	1/4 MALE N.O. PRESSURE SWITCH	1.000	PC	VL1102A1	DETERGENT LINE FILTER + BARBED VNR 6 MM	1.000	PC	VL1128A1	D6 BARBED CHECK VALVE	2.000	PC	VL1166A0	BB6-AR6 L FITTING	3.000	PC	VL1174C0	D1.2 MM CALIBRATED D1.2 MM	1.000	PC	VL1185A0	2 WAYS PLUS WASHING DISTRIBUTOR	1.000	PC
					Code	Description	Qty	UOM																																																																																	
					GN1526A0	INT. D.=6.9 TH=1.8 O-RIN	7.000	PC																																																																																	
					RC1018A0	ZINC PLATED D12 ELASTIC CLAMP	2.000	PC																																																																																	
					RC1019A0	D=10 ELASTIC CLAMP	14.000	PC																																																																																	
					RC1130A0	130x2.6 CLAM	1.000	PC																																																																																	
					RC1131A0	200x2.6 BLACK CLAMP	2.000	PC																																																																																	
					RC1242A0	D=10 CLOSED CAP	2.000	PC																																																																																	
					RC1356A0	"STRAIGHT THREADED FEMALE END 8x1/4" BS	1.000	PC																																																																																	
					TB2821A0	EPDM 6X10 L=40MM PIPE	6.000	PC																																																																																	
					TB3004A0	TB2820A L=550mm EPDM BLACK PIPE	1.000	PC																																																																																	
					TB3005B0	TB3132A L=550mm EPDM WHITE-BLUE PIPE	1.000	PC																																																																																	
					TB3225B0	TB2820A-TAN K-WASHYNG SYS CONNECTION	1.000	PC																																																																																	
					TB3252A0	TB3252A0	1.000	PC																																																																																	
					VL1019A0	VIBRATION DETERGENT PUMP	1.000	PC																																																																																	
					VL1047A1	D6 PIPE HOLDER - D6 J.G. TERMINAL	1.000	PC																																																																																	
					VL1065A1	1/4 MALE N.O. PRESSURE SWITCH	1.000	PC																																																																																	
					VL1102A1	DETERGENT LINE FILTER + BARBED VNR 6 MM	1.000	PC																																																																																	
					VL1128A1	D6 BARBED CHECK VALVE	2.000	PC																																																																																	
					VL1166A0	BB6-AR6 L FITTING	3.000	PC																																																																																	
VL1174C0	D1.2 MM CALIBRATED D1.2 MM	1.000	PC																																																																																						
VL1185A0	2 WAYS PLUS WASHING DISTRIBUTOR	1.000	PC																																																																																						





COMPONENT			SPARE PART																																																			
Code	Description	Image	Code	Description	Kit components																																																	
VL1190A	PLUS WASHING SYSTEM INLET DISTRIBUTOR		KVL1183A	1 ROTOR ARM PLUS CLEANING SYSTEM KIT	<table border="1"> <thead> <tr> <th>Code</th> <th>Description</th> <th>Qty</th> <th>UOM</th> </tr> </thead> <tbody> <tr> <td>VL1190A0</td> <td>PLUS WASHING SYSTEM INLET DISTRIBUTOR</td> <td>1.000</td> <td>PC</td> </tr> <tr> <td>VL1214A0</td> <td>BAYONET - 6mm BARBED NRV VALVE</td> <td>1.000</td> <td>PC</td> </tr> <tr> <td>VM1605A0</td> <td>CLIP TWIST LOCK DIAM. 10,2-12,7 MM</td> <td>3.000</td> <td>PC</td> </tr> <tr> <td>VM2172A0</td> <td>LOCKING CLIP FOR PUMP WITH CIRCUIT</td> <td>4.000</td> <td>PC</td> </tr> </tbody> </table>	Code	Description	Qty	UOM	VL1190A0	PLUS WASHING SYSTEM INLET DISTRIBUTOR	1.000	PC	VL1214A0	BAYONET - 6mm BARBED NRV VALVE	1.000	PC	VM1605A0	CLIP TWIST LOCK DIAM. 10,2-12,7 MM	3.000	PC	VM2172A0	LOCKING CLIP FOR PUMP WITH CIRCUIT	4.000	PC																													
			Code	Description	Qty	UOM																																																
			VL1190A0	PLUS WASHING SYSTEM INLET DISTRIBUTOR	1.000	PC																																																
VL1214A0	BAYONET - 6mm BARBED NRV VALVE	1.000	PC																																																			
VM1605A0	CLIP TWIST LOCK DIAM. 10,2-12,7 MM	3.000	PC																																																			
VM2172A0	LOCKING CLIP FOR PUMP WITH CIRCUIT	4.000	PC																																																			
KVL0684A	>12/2019 2-3ROTOR ARM PLUS WASH PUMP KIT	<table border="1"> <thead> <tr> <th>Code</th> <th>Description</th> <th>Qty</th> <th>UOM</th> </tr> </thead> <tbody> <tr> <td>GN1526A0</td> <td>INT. D.=6.9 TH=1.8 O-RIN</td> <td>3.000</td> <td>PC</td> </tr> <tr> <td>RC1019A0</td> <td>D=10 ELASTIC CLAMP</td> <td>4.000</td> <td>PC</td> </tr> <tr> <td>RC1130A0</td> <td>130x2.6 CLAM</td> <td>1.000</td> <td>PC</td> </tr> <tr> <td>RC1131A0</td> <td>200x2.6 BLACK CLAMP</td> <td>3.000</td> <td>PC</td> </tr> <tr> <td>RC1242A0</td> <td>D=10 CLOSED CAP</td> <td>2.000</td> <td>PC</td> </tr> <tr> <td>TB2821A0</td> <td>EPDM 6X10 L=40MM PIPE</td> <td>3.000</td> <td>PC</td> </tr> <tr> <td>VL1019A0</td> <td>VIBRATION DETERGENT PUMP</td> <td>1.000</td> <td>PC</td> </tr> <tr> <td>VL1128A1</td> <td>D6 BARBED CHECK VALVE</td> <td>1.000</td> <td>PC</td> </tr> <tr> <td>VL1174C0</td> <td>D1.2 MM CALIBRATED D1.2 MM</td> <td>1.000</td> <td>PC</td> </tr> <tr> <td>VL1186A0</td> <td>3 WAYS PLUS WASHING DISTRIBUTOR</td> <td>1.000</td> <td>PC</td> </tr> <tr> <td>VL1190A0</td> <td>PLUS WASHING SYSTEM INLET DISTRIBUTOR</td> <td>1.000</td> <td>PC</td> </tr> <tr> <td>VM2172A0</td> <td>LOCKING CLIP FOR PUMP WITH CIRCUIT</td> <td>1.000</td> <td>PC</td> </tr> </tbody> </table>	Code	Description	Qty	UOM	GN1526A0	INT. D.=6.9 TH=1.8 O-RIN	3.000	PC	RC1019A0	D=10 ELASTIC CLAMP	4.000	PC	RC1130A0	130x2.6 CLAM	1.000	PC	RC1131A0	200x2.6 BLACK CLAMP	3.000	PC	RC1242A0	D=10 CLOSED CAP	2.000	PC	TB2821A0	EPDM 6X10 L=40MM PIPE	3.000	PC	VL1019A0	VIBRATION DETERGENT PUMP	1.000	PC	VL1128A1	D6 BARBED CHECK VALVE	1.000	PC	VL1174C0	D1.2 MM CALIBRATED D1.2 MM	1.000	PC	VL1186A0	3 WAYS PLUS WASHING DISTRIBUTOR	1.000	PC	VL1190A0	PLUS WASHING SYSTEM INLET DISTRIBUTOR	1.000	PC	VM2172A0	LOCKING CLIP FOR PUMP WITH CIRCUIT	1.000	PC
Code	Description	Qty	UOM																																																			
GN1526A0	INT. D.=6.9 TH=1.8 O-RIN	3.000	PC																																																			
RC1019A0	D=10 ELASTIC CLAMP	4.000	PC																																																			
RC1130A0	130x2.6 CLAM	1.000	PC																																																			
RC1131A0	200x2.6 BLACK CLAMP	3.000	PC																																																			
RC1242A0	D=10 CLOSED CAP	2.000	PC																																																			
TB2821A0	EPDM 6X10 L=40MM PIPE	3.000	PC																																																			
VL1019A0	VIBRATION DETERGENT PUMP	1.000	PC																																																			
VL1128A1	D6 BARBED CHECK VALVE	1.000	PC																																																			
VL1174C0	D1.2 MM CALIBRATED D1.2 MM	1.000	PC																																																			
VL1186A0	3 WAYS PLUS WASHING DISTRIBUTOR	1.000	PC																																																			
VL1190A0	PLUS WASHING SYSTEM INLET DISTRIBUTOR	1.000	PC																																																			
VM2172A0	LOCKING CLIP FOR PUMP WITH CIRCUIT	1.000	PC																																																			
KVL0683A	>12/2019 1 ROTOR ARM PLUS WASH PUMP KIT	<table border="1"> <thead> <tr> <th>Code</th> <th>Description</th> <th>Qty</th> <th>UOM</th> </tr> </thead> <tbody> <tr> <td>GN1526A0</td> <td>INT. D.=6.9 TH=1.8 O-RIN</td> <td>2.000</td> <td>PC</td> </tr> <tr> <td>RC1019A0</td> <td>D=10 ELASTIC CLAMP</td> <td>4.000</td> <td>PC</td> </tr> <tr> <td>RC1130A0</td> <td>130x2.6 CLAM</td> <td>1.000</td> <td>PC</td> </tr> <tr> <td>RC1131A0</td> <td>200x2.6 BLACK CLAMP</td> <td>2.000</td> <td>PC</td> </tr> </tbody> </table>	Code	Description	Qty	UOM	GN1526A0	INT. D.=6.9 TH=1.8 O-RIN	2.000	PC	RC1019A0	D=10 ELASTIC CLAMP	4.000	PC	RC1130A0	130x2.6 CLAM	1.000	PC	RC1131A0	200x2.6 BLACK CLAMP	2.000	PC																																
Code	Description	Qty	UOM																																																			
GN1526A0	INT. D.=6.9 TH=1.8 O-RIN	2.000	PC																																																			
RC1019A0	D=10 ELASTIC CLAMP	4.000	PC																																																			
RC1130A0	130x2.6 CLAM	1.000	PC																																																			
RC1131A0	200x2.6 BLACK CLAMP	2.000	PC																																																			

COMPONENT			SPARE PART																																						
Code	Description	Image	Code	Description	Kit components																																				
VL1190A	PLUS WASHING SYSTEM INLET DISTRIBUTOR		KVL0683A	>12/2019 1 ROTOR ARM PLUS WASH PUMP KIT	<table border="1"> <thead> <tr> <th>Code</th> <th>Description</th> <th>Qty</th> <th>UOM</th> </tr> </thead> <tbody> <tr> <td>RC1242A0</td> <td>D=10 CLOSED CAP</td> <td>2.000</td> <td>PC</td> </tr> <tr> <td>TB2821A0</td> <td>EPDM 6X10 L=40MM PIPE</td> <td>3.000</td> <td>PC</td> </tr> <tr> <td>VL1019A0</td> <td>VIBRATION DETERGENT PUMP</td> <td>1.000</td> <td>PC</td> </tr> <tr> <td>VL1128A1</td> <td>D6 BARBED CHECK VALVE</td> <td>1.000</td> <td>PC</td> </tr> <tr> <td>VL1174C0</td> <td>D1.2 MM CALIBRATED D1.2 MM</td> <td>1.000</td> <td>PC</td> </tr> <tr> <td>VL1185A0</td> <td>2 WAYS PLUS WASHING DISTRIBUTOR</td> <td>1.000</td> <td>PC</td> </tr> <tr> <td>VL1190A0</td> <td>PLUS WASHING SYSTEM INLET DISTRIBUTOR</td> <td>1.000</td> <td>PC</td> </tr> <tr> <td>VM2172A0</td> <td>LOCKING CLIP FOR PUMP WITH CIRCUIT</td> <td>1.000</td> <td>PC</td> </tr> </tbody> </table>	Code	Description	Qty	UOM	RC1242A0	D=10 CLOSED CAP	2.000	PC	TB2821A0	EPDM 6X10 L=40MM PIPE	3.000	PC	VL1019A0	VIBRATION DETERGENT PUMP	1.000	PC	VL1128A1	D6 BARBED CHECK VALVE	1.000	PC	VL1174C0	D1.2 MM CALIBRATED D1.2 MM	1.000	PC	VL1185A0	2 WAYS PLUS WASHING DISTRIBUTOR	1.000	PC	VL1190A0	PLUS WASHING SYSTEM INLET DISTRIBUTOR	1.000	PC	VM2172A0	LOCKING CLIP FOR PUMP WITH CIRCUIT	1.000	PC
					Code	Description	Qty	UOM																																	
					RC1242A0	D=10 CLOSED CAP	2.000	PC																																	
					TB2821A0	EPDM 6X10 L=40MM PIPE	3.000	PC																																	
					VL1019A0	VIBRATION DETERGENT PUMP	1.000	PC																																	
					VL1128A1	D6 BARBED CHECK VALVE	1.000	PC																																	
					VL1174C0	D1.2 MM CALIBRATED D1.2 MM	1.000	PC																																	
					VL1185A0	2 WAYS PLUS WASHING DISTRIBUTOR	1.000	PC																																	
					VL1190A0	PLUS WASHING SYSTEM INLET DISTRIBUTOR	1.000	PC																																	
VM2172A0	LOCKING CLIP FOR PUMP WITH CIRCUIT	1.000	PC																																						
VL1214A	BAYONET - 6mm BARBED NRV VALVE		KVL1214A	6mm BARBED-BAYONET NRV VALVE KIT	<table border="1"> <thead> <tr> <th>Code</th> <th>Description</th> <th>Qty</th> <th>UOM</th> </tr> </thead> <tbody> <tr> <td>RC1019A0</td> <td>D=10 ELASTIC CLAMP</td> <td>2.000</td> <td>PC</td> </tr> <tr> <td>TB2820A0</td> <td>6X10 EPDM PIPE FOR WASHING SYSTEM</td> <td>0.100</td> <td>M</td> </tr> <tr> <td>VL1214A0</td> <td>BAYONET - 6mm BARBED NRV VALVE</td> <td>1.000</td> <td>PC</td> </tr> </tbody> </table>	Code	Description	Qty	UOM	RC1019A0	D=10 ELASTIC CLAMP	2.000	PC	TB2820A0	6X10 EPDM PIPE FOR WASHING SYSTEM	0.100	M	VL1214A0	BAYONET - 6mm BARBED NRV VALVE	1.000	PC																				
					Code	Description	Qty	UOM																																	
					RC1019A0	D=10 ELASTIC CLAMP	2.000	PC																																	
TB2820A0	6X10 EPDM PIPE FOR WASHING SYSTEM	0.100	M																																						
VL1214A0	BAYONET - 6mm BARBED NRV VALVE	1.000	PC																																						
VL1398A	1/4 M N.O. CIL PRESSURE SWITCH		KVL1065A	1/4 M N.O. CIL. PRESSURE SWITCH KIT	<table border="1"> <thead> <tr> <th>Code</th> <th>Description</th> <th>Qty</th> <th>UOM</th> </tr> </thead> <tbody> <tr> <td>VL1065A1</td> <td>1/4 MALE N.O. PRESSURE SWITCH</td> <td>1.000</td> <td>PC</td> </tr> </tbody> </table>	Code	Description	Qty	UOM	VL1065A1	1/4 MALE N.O. PRESSURE SWITCH	1.000	PC																												
					Code	Description	Qty	UOM																																	
VL1065A1	1/4 MALE N.O. PRESSURE SWITCH	1.000	PC																																						

COMPONENT			SPARE PART																																																																						
Code	Description	Image	Code	Description	Kit components																																																																				
VM2172A	LOCKING CLIP FOR PUMP WITH CIRCUIT		VM2172A0	LOCKING CLIP FOR PUMP WITH CIRCUIT																																																																					
EL1440A	WATER SELF CLEANING VALVE		KVL2618A	2 ROTOR ARMS ONE CLEANING SYSTEM KIT	<table border="1"> <thead> <tr> <th>Code</th> <th>Description</th> <th>Qty</th> <th>UOM</th> </tr> </thead> <tbody> <tr> <td>0H2202A1</td> <td>ONE WASHING WITH STEAM VALVE SUPPORT</td> <td>2.000</td> <td>PC</td> </tr> <tr> <td>CE1030A0</td> <td>FEMALE FASTON COVER 6.3X0.8 0,5-1mmq</td> <td>4.000</td> <td>PC</td> </tr> <tr> <td>CE1395A0</td> <td>6,3 X 0,8 FEMALE FASTON</td> <td>2.000</td> <td>PC</td> </tr> <tr> <td>CE1545A0</td> <td>BLUE UNIP AWG18 ST.3135 WIRE</td> <td>2.000</td> <td>M</td> </tr> <tr> <td>CE1570A0</td> <td>WHITE UNIP AWG18 ST.3135 WIRE</td> <td>2.000</td> <td>M</td> </tr> <tr> <td>CE1660A0</td> <td>6,3x0,8 FEMALE FASTON COVER</td> <td>4.000</td> <td>PC</td> </tr> <tr> <td>CE1661A0</td> <td>MALE FASTON COVER 6,3x0,8</td> <td>2.000</td> <td>PC</td> </tr> <tr> <td>EL1020A1</td> <td>D8 INTERMEDIAT E T-SHAPED FITTING</td> <td>1.000</td> <td>PC</td> </tr> <tr> <td>EL1440A0</td> <td>WATER SELF CLEANING VALVE</td> <td>2.000</td> <td>PC</td> </tr> <tr> <td>GN1526A0</td> <td>INT. D.=6.9 TH=1.8 O-RING</td> <td>6.000</td> <td>PC</td> </tr> <tr> <td>RC1018A0</td> <td>ZINC PLATED D12 ELASTIC CLAMP</td> <td>2.000</td> <td>PC</td> </tr> <tr> <td>RC1019A0</td> <td>D=10 ELASTIC CLAMP</td> <td>28.000</td> <td>PC</td> </tr> <tr> <td>RC1130A0</td> <td>130x2,6 CLAMP</td> <td>4.000</td> <td>PC</td> </tr> <tr> <td>RC1242A0</td> <td>D=10 CLOSED CAP</td> <td>4.000</td> <td>PC</td> </tr> <tr> <td>TB2821A0</td> <td>EPDM 6X10 L=40MM PIPE</td> <td>12.000</td> <td>PC</td> </tr> <tr> <td>TB3004A0</td> <td>TB2820A L=550mm EPDM BLACK PIPE</td> <td>2.000</td> <td>PC</td> </tr> </tbody> </table>	Code	Description	Qty	UOM	0H2202A1	ONE WASHING WITH STEAM VALVE SUPPORT	2.000	PC	CE1030A0	FEMALE FASTON COVER 6.3X0.8 0,5-1mmq	4.000	PC	CE1395A0	6,3 X 0,8 FEMALE FASTON	2.000	PC	CE1545A0	BLUE UNIP AWG18 ST.3135 WIRE	2.000	M	CE1570A0	WHITE UNIP AWG18 ST.3135 WIRE	2.000	M	CE1660A0	6,3x0,8 FEMALE FASTON COVER	4.000	PC	CE1661A0	MALE FASTON COVER 6,3x0,8	2.000	PC	EL1020A1	D8 INTERMEDIAT E T-SHAPED FITTING	1.000	PC	EL1440A0	WATER SELF CLEANING VALVE	2.000	PC	GN1526A0	INT. D.=6.9 TH=1.8 O-RING	6.000	PC	RC1018A0	ZINC PLATED D12 ELASTIC CLAMP	2.000	PC	RC1019A0	D=10 ELASTIC CLAMP	28.000	PC	RC1130A0	130x2,6 CLAMP	4.000	PC	RC1242A0	D=10 CLOSED CAP	4.000	PC	TB2821A0	EPDM 6X10 L=40MM PIPE	12.000	PC	TB3004A0	TB2820A L=550mm EPDM BLACK PIPE	2.000	PC
Code	Description	Qty	UOM																																																																						
0H2202A1	ONE WASHING WITH STEAM VALVE SUPPORT	2.000	PC																																																																						
CE1030A0	FEMALE FASTON COVER 6.3X0.8 0,5-1mmq	4.000	PC																																																																						
CE1395A0	6,3 X 0,8 FEMALE FASTON	2.000	PC																																																																						
CE1545A0	BLUE UNIP AWG18 ST.3135 WIRE	2.000	M																																																																						
CE1570A0	WHITE UNIP AWG18 ST.3135 WIRE	2.000	M																																																																						
CE1660A0	6,3x0,8 FEMALE FASTON COVER	4.000	PC																																																																						
CE1661A0	MALE FASTON COVER 6,3x0,8	2.000	PC																																																																						
EL1020A1	D8 INTERMEDIAT E T-SHAPED FITTING	1.000	PC																																																																						
EL1440A0	WATER SELF CLEANING VALVE	2.000	PC																																																																						
GN1526A0	INT. D.=6.9 TH=1.8 O-RING	6.000	PC																																																																						
RC1018A0	ZINC PLATED D12 ELASTIC CLAMP	2.000	PC																																																																						
RC1019A0	D=10 ELASTIC CLAMP	28.000	PC																																																																						
RC1130A0	130x2,6 CLAMP	4.000	PC																																																																						
RC1242A0	D=10 CLOSED CAP	4.000	PC																																																																						
TB2821A0	EPDM 6X10 L=40MM PIPE	12.000	PC																																																																						
TB3004A0	TB2820A L=550mm EPDM BLACK PIPE	2.000	PC																																																																						

COMPONENT			SPARE PART																																																																																	
Code	Description	Image	Code	Description	Kit components																																																																															
EL1440A	WATER SELF CLEANING VALVE		KVL2618A	2 ROTOR ARMS ONE CLEANING SYSTEM KIT	<table border="1"> <thead> <tr> <th>Code</th> <th>Description</th> <th>Qty</th> <th>UOM</th> </tr> </thead> <tbody> <tr> <td>TB3009B0</td> <td>TB3132A-ONE OVEN WASHING INLET</td> <td>2.000</td> <td>PC</td> </tr> <tr> <td>TB3225B0</td> <td>TB2820A-TAN K-WASHYNG SYS CONNECTION</td> <td>2.000</td> <td>PC</td> </tr> <tr> <td>VI1220A1</td> <td>4,2x12 TCB SELF-TAPPIN G SCREW</td> <td>2.000</td> <td>PC</td> </tr> <tr> <td>VL1019A0</td> <td>VIBRATION DETERGENT PUMP</td> <td>2.000</td> <td>PC</td> </tr> <tr> <td>VL1047A1</td> <td>D6 PIPE HOLDER - D8 J.G. TERMINAL</td> <td>2.000</td> <td>PC</td> </tr> <tr> <td>VL1054B0</td> <td>ONE WASHING SYS INLET DISTRIBUTOR</td> <td>2.000</td> <td>PC</td> </tr> <tr> <td>VL1102A1</td> <td>DETERGENT LINE FILTER + BARBED VNR 6 MM</td> <td>2.000</td> <td>PC</td> </tr> <tr> <td>VL1127A1</td> <td>6mm BARBED T-SHAPED FITTING</td> <td>1.000</td> <td>PC</td> </tr> <tr> <td>VL1128A1</td> <td>D6 BARBED CHECK VALVE</td> <td>4.000</td> <td>PC</td> </tr> <tr> <td>VL1166A0</td> <td>BB6-AR6 L FITTING</td> <td>2.000</td> <td>PC</td> </tr> <tr> <td>VL1174C0</td> <td>D1.2 MM CALIBRATED D1.2 MM</td> <td>2.000</td> <td>PC</td> </tr> <tr> <td>VL1191A0</td> <td>ONE WASHING DISTRIBUTOR OUTLETS KIT</td> <td>2.000</td> <td>PC</td> </tr> <tr> <td>VL1214A0</td> <td>BAYONET - 6mm BARBED NRV VALVE</td> <td>2.000</td> <td>PC</td> </tr> <tr> <td>VM2172A0</td> <td>LOCKING CLIP FOR PUMP WITH CIRCUIT</td> <td>4.000</td> <td>PC</td> </tr> </tbody> </table>	Code	Description	Qty	UOM	TB3009B0	TB3132A-ONE OVEN WASHING INLET	2.000	PC	TB3225B0	TB2820A-TAN K-WASHYNG SYS CONNECTION	2.000	PC	VI1220A1	4,2x12 TCB SELF-TAPPIN G SCREW	2.000	PC	VL1019A0	VIBRATION DETERGENT PUMP	2.000	PC	VL1047A1	D6 PIPE HOLDER - D8 J.G. TERMINAL	2.000	PC	VL1054B0	ONE WASHING SYS INLET DISTRIBUTOR	2.000	PC	VL1102A1	DETERGENT LINE FILTER + BARBED VNR 6 MM	2.000	PC	VL1127A1	6mm BARBED T-SHAPED FITTING	1.000	PC	VL1128A1	D6 BARBED CHECK VALVE	4.000	PC	VL1166A0	BB6-AR6 L FITTING	2.000	PC	VL1174C0	D1.2 MM CALIBRATED D1.2 MM	2.000	PC	VL1191A0	ONE WASHING DISTRIBUTOR OUTLETS KIT	2.000	PC	VL1214A0	BAYONET - 6mm BARBED NRV VALVE	2.000	PC	VM2172A0	LOCKING CLIP FOR PUMP WITH CIRCUIT	4.000	PC	KVL1222A	EUR 0311 ONE PLUS CLEANING SYSTEM KIT	<table border="1"> <thead> <tr> <th>Code</th> <th>Description</th> <th>Qty</th> <th>UOM</th> </tr> </thead> <tbody> <tr> <td>0H2486A0</td> <td>0311 WASHING CIRCUIT PLAT</td> <td>1.000</td> <td>PC</td> </tr> <tr> <td>EL1440A0</td> <td>WATER SELF CLEANING VALVE</td> <td>1.000</td> <td>PC</td> </tr> <tr> <td>GN1526A0</td> <td>INT. D.=6.9 TH=1.8 O-RIN</td> <td>3.000</td> <td>PC</td> </tr> </tbody> </table>	Code	Description	Qty	UOM	0H2486A0	0311 WASHING CIRCUIT PLAT	1.000	PC	EL1440A0	WATER SELF CLEANING VALVE	1.000	PC	GN1526A0	INT. D.=6.9 TH=1.8 O-RIN	3.000	PC
			Code	Description	Qty	UOM																																																																														
TB3009B0	TB3132A-ONE OVEN WASHING INLET	2.000	PC																																																																																	
TB3225B0	TB2820A-TAN K-WASHYNG SYS CONNECTION	2.000	PC																																																																																	
VI1220A1	4,2x12 TCB SELF-TAPPIN G SCREW	2.000	PC																																																																																	
VL1019A0	VIBRATION DETERGENT PUMP	2.000	PC																																																																																	
VL1047A1	D6 PIPE HOLDER - D8 J.G. TERMINAL	2.000	PC																																																																																	
VL1054B0	ONE WASHING SYS INLET DISTRIBUTOR	2.000	PC																																																																																	
VL1102A1	DETERGENT LINE FILTER + BARBED VNR 6 MM	2.000	PC																																																																																	
VL1127A1	6mm BARBED T-SHAPED FITTING	1.000	PC																																																																																	
VL1128A1	D6 BARBED CHECK VALVE	4.000	PC																																																																																	
VL1166A0	BB6-AR6 L FITTING	2.000	PC																																																																																	
VL1174C0	D1.2 MM CALIBRATED D1.2 MM	2.000	PC																																																																																	
VL1191A0	ONE WASHING DISTRIBUTOR OUTLETS KIT	2.000	PC																																																																																	
VL1214A0	BAYONET - 6mm BARBED NRV VALVE	2.000	PC																																																																																	
VM2172A0	LOCKING CLIP FOR PUMP WITH CIRCUIT	4.000	PC																																																																																	
Code	Description	Qty	UOM																																																																																	
0H2486A0	0311 WASHING CIRCUIT PLAT	1.000	PC																																																																																	
EL1440A0	WATER SELF CLEANING VALVE	1.000	PC																																																																																	
GN1526A0	INT. D.=6.9 TH=1.8 O-RIN	3.000	PC																																																																																	

COMPONENT			SPARE PART																																																																														
Code	Description	Image	Code	Description	Kit components																																																																												
EL1440A	WATER SELF CLEANING VALVE		KVL1222A	EUR 0311 ONE PLUS CLEANING SYSTEM KIT	<table border="1"> <thead> <tr> <th>Code</th> <th>Description</th> <th>Qty</th> <th>UOM</th> </tr> </thead> <tbody> <tr> <td>RC1018A0</td> <td>ZINC PLATED D12 ELASTIC CLAMP</td> <td>1.000</td> <td>PC</td> </tr> <tr> <td>RC1019A0</td> <td>D=10 ELASTIC CLAMP</td> <td>14.000</td> <td>PC</td> </tr> <tr> <td>RC1242A0</td> <td>D=10 CLOSED CAP</td> <td>2.000</td> <td>PC</td> </tr> <tr> <td>TB2821A0</td> <td>EPDM 6X10 L=40MM PIPE</td> <td>6.000</td> <td>PC</td> </tr> <tr> <td>TB3004A0</td> <td>TB2820A L=550mm EPDM BLACK PIPE</td> <td>1.000</td> <td>PC</td> </tr> <tr> <td>TB3009B0</td> <td>TB3132A-ONE OVEN WASHING INLET</td> <td>1.000</td> <td>PC</td> </tr> <tr> <td>TB3225B0</td> <td>TB2820A-TAN K-WASHYNG SYS CONNECTION</td> <td>1.000</td> <td>PC</td> </tr> <tr> <td>VI1220A1</td> <td>4,2x12 TCB SELF-TAPPIN G SCREW</td> <td>4.000</td> <td>PC</td> </tr> <tr> <td>VL1019A0</td> <td>VIBRATION DETERGENT PUMP</td> <td>1.000</td> <td>PC</td> </tr> <tr> <td>VL1047A1</td> <td>D6 PIPE HOLDER - D8 J.G. TERMINAL</td> <td>1.000</td> <td>PC</td> </tr> <tr> <td>VL1054B0</td> <td>ONE WASHING SYS INLET DISTRIBUTOR</td> <td>1.000</td> <td>PC</td> </tr> <tr> <td>VL1102A1</td> <td>DETERGENT LINE FILTER + BARBED VNR 6 MM</td> <td>1.000</td> <td>PC</td> </tr> <tr> <td>VL1128A1</td> <td>D6 BARBED CHECK VALVE</td> <td>2.000</td> <td>PC</td> </tr> <tr> <td>VL1166A0</td> <td>BB6-AR6 L FITTING</td> <td>1.000</td> <td>PC</td> </tr> <tr> <td>VL1174C0</td> <td>D1.2 MM CALIBRATED D1.2 MM</td> <td>1.000</td> <td>PC</td> </tr> <tr> <td>VL1191A0</td> <td>ONE WASHING DISTRIBUTOR OUTLETS KIT</td> <td>1.000</td> <td>PC</td> </tr> <tr> <td>VL1214A0</td> <td>BAYONET - 6mm BARBED NRV VALVE</td> <td>1.000</td> <td>PC</td> </tr> <tr> <td>VM2172A0</td> <td>LOCKING CLIP FOR PUMP WITH CIRCUIT</td> <td>2.000</td> <td>PC</td> </tr> </tbody> </table>	Code	Description	Qty	UOM	RC1018A0	ZINC PLATED D12 ELASTIC CLAMP	1.000	PC	RC1019A0	D=10 ELASTIC CLAMP	14.000	PC	RC1242A0	D=10 CLOSED CAP	2.000	PC	TB2821A0	EPDM 6X10 L=40MM PIPE	6.000	PC	TB3004A0	TB2820A L=550mm EPDM BLACK PIPE	1.000	PC	TB3009B0	TB3132A-ONE OVEN WASHING INLET	1.000	PC	TB3225B0	TB2820A-TAN K-WASHYNG SYS CONNECTION	1.000	PC	VI1220A1	4,2x12 TCB SELF-TAPPIN G SCREW	4.000	PC	VL1019A0	VIBRATION DETERGENT PUMP	1.000	PC	VL1047A1	D6 PIPE HOLDER - D8 J.G. TERMINAL	1.000	PC	VL1054B0	ONE WASHING SYS INLET DISTRIBUTOR	1.000	PC	VL1102A1	DETERGENT LINE FILTER + BARBED VNR 6 MM	1.000	PC	VL1128A1	D6 BARBED CHECK VALVE	2.000	PC	VL1166A0	BB6-AR6 L FITTING	1.000	PC	VL1174C0	D1.2 MM CALIBRATED D1.2 MM	1.000	PC	VL1191A0	ONE WASHING DISTRIBUTOR OUTLETS KIT	1.000	PC	VL1214A0	BAYONET - 6mm BARBED NRV VALVE	1.000	PC	VM2172A0	LOCKING CLIP FOR PUMP WITH CIRCUIT	2.000	PC
Code	Description	Qty	UOM																																																																														
RC1018A0	ZINC PLATED D12 ELASTIC CLAMP	1.000	PC																																																																														
RC1019A0	D=10 ELASTIC CLAMP	14.000	PC																																																																														
RC1242A0	D=10 CLOSED CAP	2.000	PC																																																																														
TB2821A0	EPDM 6X10 L=40MM PIPE	6.000	PC																																																																														
TB3004A0	TB2820A L=550mm EPDM BLACK PIPE	1.000	PC																																																																														
TB3009B0	TB3132A-ONE OVEN WASHING INLET	1.000	PC																																																																														
TB3225B0	TB2820A-TAN K-WASHYNG SYS CONNECTION	1.000	PC																																																																														
VI1220A1	4,2x12 TCB SELF-TAPPIN G SCREW	4.000	PC																																																																														
VL1019A0	VIBRATION DETERGENT PUMP	1.000	PC																																																																														
VL1047A1	D6 PIPE HOLDER - D8 J.G. TERMINAL	1.000	PC																																																																														
VL1054B0	ONE WASHING SYS INLET DISTRIBUTOR	1.000	PC																																																																														
VL1102A1	DETERGENT LINE FILTER + BARBED VNR 6 MM	1.000	PC																																																																														
VL1128A1	D6 BARBED CHECK VALVE	2.000	PC																																																																														
VL1166A0	BB6-AR6 L FITTING	1.000	PC																																																																														
VL1174C0	D1.2 MM CALIBRATED D1.2 MM	1.000	PC																																																																														
VL1191A0	ONE WASHING DISTRIBUTOR OUTLETS KIT	1.000	PC																																																																														
VL1214A0	BAYONET - 6mm BARBED NRV VALVE	1.000	PC																																																																														
VM2172A0	LOCKING CLIP FOR PUMP WITH CIRCUIT	2.000	PC																																																																														

COMPONENT			SPARE PART																																																																																		
Code	Description	Image	Code	Description	Kit components																																																																																
EL1440A	WATER SELF CLEANING VALVE		KVL1212A	EUR COMPACT PLUS CLEANING SYSTEM KIT	<table border="1"> <thead> <tr> <th>Code</th> <th>Description</th> <th>Qty</th> <th>UOM</th> </tr> </thead> <tbody> <tr> <td>0H2428A2</td> <td>XECC PLUS WASHING CIRCUIT PLAT</td> <td>1.000</td> <td>PC</td> </tr> <tr> <td>EL1440A0</td> <td>WATER SELF CLEANING VALVE</td> <td>3.000</td> <td>PC</td> </tr> <tr> <td>GN1312A0</td> <td>RUBBER CABLE-PASSI NG DE=26 DI=15 SP=10</td> <td>1.000</td> <td>PC</td> </tr> <tr> <td>GN1526A0</td> <td>INT. D.=6.9 TH=1.8 O-RIN</td> <td>7.000</td> <td>PC</td> </tr> <tr> <td>RC1018A0</td> <td>ZINC PLATED D12 ELASTIC CLAMP</td> <td>2.000</td> <td>PC</td> </tr> <tr> <td>RC1019A0</td> <td>D=10 ELASTIC CLAMP</td> <td>14.000</td> <td>PC</td> </tr> <tr> <td>RC1130A0</td> <td>130x2,6 CLAM</td> <td>1.000</td> <td>PC</td> </tr> <tr> <td>RC1131A0</td> <td>200x2,6 BLACK CLAMP</td> <td>1.000</td> <td>PC</td> </tr> <tr> <td>RC1242A0</td> <td>D=10 CLOSED CAP</td> <td>2.000</td> <td>PC</td> </tr> <tr> <td>RC1356A0</td> <td>"STRAIGHT THREADED FEMALE END 8x1/4" BS</td> <td>1.000</td> <td>PC</td> </tr> <tr> <td>TB2821A0</td> <td>EPDM 6X10 L=40MM PIPE</td> <td>6.000</td> <td>PC</td> </tr> <tr> <td>TB3004A0</td> <td>TB2820A L=550mm EPDM BLACK PIPE</td> <td>2.000</td> <td>PC</td> </tr> <tr> <td>TB3005B0</td> <td>TB3132A L=550mm EPDM WHITE-BLUE PIPE</td> <td>1.000</td> <td>PC</td> </tr> <tr> <td>TB3469A0</td> <td></td> <td>1.000</td> <td>PC</td> </tr> <tr> <td>VL1019A0</td> <td>VIBRATION DETERGENT PUMP</td> <td>1.000</td> <td>PC</td> </tr> <tr> <td>VL1047A1</td> <td>D6 PIPE HOLDER - D8 J.G. TERMINAL</td> <td>1.000</td> <td>PC</td> </tr> <tr> <td>VL1054B0</td> <td>ONE WASHING SYS INLET DISTRIBUTOR</td> <td>1.000</td> <td>PC</td> </tr> <tr> <td>VL1065A1</td> <td>1/4 MALE N.O. PRESSURE SWITCH</td> <td>1.000</td> <td>PC</td> </tr> <tr> <td>VL1102A1</td> <td>DETERGENT LINE FILTER + BARBED VNR 6 MM</td> <td>1.000</td> <td>PC</td> </tr> </tbody> </table>	Code	Description	Qty	UOM	0H2428A2	XECC PLUS WASHING CIRCUIT PLAT	1.000	PC	EL1440A0	WATER SELF CLEANING VALVE	3.000	PC	GN1312A0	RUBBER CABLE-PASSI NG DE=26 DI=15 SP=10	1.000	PC	GN1526A0	INT. D.=6.9 TH=1.8 O-RIN	7.000	PC	RC1018A0	ZINC PLATED D12 ELASTIC CLAMP	2.000	PC	RC1019A0	D=10 ELASTIC CLAMP	14.000	PC	RC1130A0	130x2,6 CLAM	1.000	PC	RC1131A0	200x2,6 BLACK CLAMP	1.000	PC	RC1242A0	D=10 CLOSED CAP	2.000	PC	RC1356A0	"STRAIGHT THREADED FEMALE END 8x1/4" BS	1.000	PC	TB2821A0	EPDM 6X10 L=40MM PIPE	6.000	PC	TB3004A0	TB2820A L=550mm EPDM BLACK PIPE	2.000	PC	TB3005B0	TB3132A L=550mm EPDM WHITE-BLUE PIPE	1.000	PC	TB3469A0		1.000	PC	VL1019A0	VIBRATION DETERGENT PUMP	1.000	PC	VL1047A1	D6 PIPE HOLDER - D8 J.G. TERMINAL	1.000	PC	VL1054B0	ONE WASHING SYS INLET DISTRIBUTOR	1.000	PC	VL1065A1	1/4 MALE N.O. PRESSURE SWITCH	1.000	PC	VL1102A1	DETERGENT LINE FILTER + BARBED VNR 6 MM	1.000	PC
Code	Description	Qty	UOM																																																																																		
0H2428A2	XECC PLUS WASHING CIRCUIT PLAT	1.000	PC																																																																																		
EL1440A0	WATER SELF CLEANING VALVE	3.000	PC																																																																																		
GN1312A0	RUBBER CABLE-PASSI NG DE=26 DI=15 SP=10	1.000	PC																																																																																		
GN1526A0	INT. D.=6.9 TH=1.8 O-RIN	7.000	PC																																																																																		
RC1018A0	ZINC PLATED D12 ELASTIC CLAMP	2.000	PC																																																																																		
RC1019A0	D=10 ELASTIC CLAMP	14.000	PC																																																																																		
RC1130A0	130x2,6 CLAM	1.000	PC																																																																																		
RC1131A0	200x2,6 BLACK CLAMP	1.000	PC																																																																																		
RC1242A0	D=10 CLOSED CAP	2.000	PC																																																																																		
RC1356A0	"STRAIGHT THREADED FEMALE END 8x1/4" BS	1.000	PC																																																																																		
TB2821A0	EPDM 6X10 L=40MM PIPE	6.000	PC																																																																																		
TB3004A0	TB2820A L=550mm EPDM BLACK PIPE	2.000	PC																																																																																		
TB3005B0	TB3132A L=550mm EPDM WHITE-BLUE PIPE	1.000	PC																																																																																		
TB3469A0		1.000	PC																																																																																		
VL1019A0	VIBRATION DETERGENT PUMP	1.000	PC																																																																																		
VL1047A1	D6 PIPE HOLDER - D8 J.G. TERMINAL	1.000	PC																																																																																		
VL1054B0	ONE WASHING SYS INLET DISTRIBUTOR	1.000	PC																																																																																		
VL1065A1	1/4 MALE N.O. PRESSURE SWITCH	1.000	PC																																																																																		
VL1102A1	DETERGENT LINE FILTER + BARBED VNR 6 MM	1.000	PC																																																																																		



COMPONENT			SPARE PART																																																											
Code	Description	Image	Code	Description	Kit components																																																									
EL1440A	WATER SELF CLEANING VALVE		KVL1212A	EUR COMPACT PLUS CLEANING SYSTEM KIT	<table border="1"> <thead> <tr> <th>Code</th> <th>Description</th> <th>Qty</th> <th>UOM</th> </tr> </thead> <tbody> <tr> <td>VL1128A1</td> <td>D6 BARBED CHECK VALVE</td> <td>2.000</td> <td>PC</td> </tr> <tr> <td>VL1165A0</td> <td>BAM-BB6 STRAIGHT FITTING</td> <td>1.000</td> <td>PC</td> </tr> <tr> <td>VL1166A0</td> <td>BB6-AR6 L FITTING</td> <td>3.000</td> <td>PC</td> </tr> <tr> <td>VL1174C0</td> <td>D1.2 MM CALIBRATED D1.2 MM</td> <td>1.000</td> <td>PC</td> </tr> <tr> <td>VL1185A0</td> <td>2 WAYS PLUS WASHING DISTRIBUTOR</td> <td>1.000</td> <td>PC</td> </tr> <tr> <td>VM2172A0</td> <td>LOCKING CLIP FOR PUMP WITH CIRCUIT</td> <td>6.000</td> <td>PC</td> </tr> </tbody> </table>	Code	Description	Qty	UOM	VL1128A1	D6 BARBED CHECK VALVE	2.000	PC	VL1165A0	BAM-BB6 STRAIGHT FITTING	1.000	PC	VL1166A0	BB6-AR6 L FITTING	3.000	PC	VL1174C0	D1.2 MM CALIBRATED D1.2 MM	1.000	PC	VL1185A0	2 WAYS PLUS WASHING DISTRIBUTOR	1.000	PC	VM2172A0	LOCKING CLIP FOR PUMP WITH CIRCUIT	6.000	PC																													
			Code	Description	Qty	UOM																																																								
VL1128A1	D6 BARBED CHECK VALVE	2.000	PC																																																											
VL1165A0	BAM-BB6 STRAIGHT FITTING	1.000	PC																																																											
VL1166A0	BB6-AR6 L FITTING	3.000	PC																																																											
VL1174C0	D1.2 MM CALIBRATED D1.2 MM	1.000	PC																																																											
VL1185A0	2 WAYS PLUS WASHING DISTRIBUTOR	1.000	PC																																																											
VM2172A0	LOCKING CLIP FOR PUMP WITH CIRCUIT	6.000	PC																																																											
KVL1211A	ONE COMPACT AND 0523-EP WASH. SYSTEM KIT	<table border="1"> <thead> <tr> <th>Code</th> <th>Description</th> <th>Qty</th> <th>UOM</th> </tr> </thead> <tbody> <tr> <td>0H2427A0</td> <td>XECC WASHING CIRCUIT HOLDING PLATE</td> <td>1.000</td> <td>PC</td> </tr> <tr> <td>EL1440A0</td> <td>WATER SELF CLEANING VALVE</td> <td>1.000</td> <td>PC</td> </tr> <tr> <td>GN1526A0</td> <td>INT. D.=6.9 TH=1.8 O-RIN</td> <td>3.000</td> <td>PC</td> </tr> <tr> <td>RC1018A0</td> <td>ZINC PLATED D12 ELASTIC CLAMP</td> <td>1.000</td> <td>PC</td> </tr> <tr> <td>RC1019A0</td> <td>D=10 ELASTIC CLAMP</td> <td>14.000</td> <td>PC</td> </tr> <tr> <td>RC1130A0</td> <td>130x2.6 CLAM</td> <td>1.000</td> <td>PC</td> </tr> <tr> <td>RC1242A0</td> <td>D=10 CLOSED CAP</td> <td>2.000</td> <td>PC</td> </tr> <tr> <td>TB1402A0</td> <td>TB2820A-DETE RGENT CIRCUIT-FILTE R PIPE</td> <td>1.000</td> <td>PC</td> </tr> <tr> <td>TB2821A0</td> <td>EPDM 6X10 L=40MM PIPE</td> <td>6.000</td> <td>PC</td> </tr> <tr> <td>TB3004A0</td> <td>TB2820A L=550mm EPDM BLACK PIPE</td> <td>1.000</td> <td>PC</td> </tr> <tr> <td>TB3469A0</td> <td></td> <td>1.000</td> <td>PC</td> </tr> <tr> <td>VI1220A1</td> <td>4,2x12 TCB SELF-TAPPIN G SCREW</td> <td>4.000</td> <td>PC</td> </tr> <tr> <td>VL1019A0</td> <td>VIBRATION DETERGENT PUMP</td> <td>1.000</td> <td>PC</td> </tr> <tr> <td>VL1047A1</td> <td>D6 PIPE HOLDER - D8 J.G. TERMINAL</td> <td>1.000</td> <td>PC</td> </tr> </tbody> </table>	Code	Description	Qty	UOM	0H2427A0	XECC WASHING CIRCUIT HOLDING PLATE	1.000	PC	EL1440A0	WATER SELF CLEANING VALVE	1.000	PC	GN1526A0	INT. D.=6.9 TH=1.8 O-RIN	3.000	PC	RC1018A0	ZINC PLATED D12 ELASTIC CLAMP	1.000	PC	RC1019A0	D=10 ELASTIC CLAMP	14.000	PC	RC1130A0	130x2.6 CLAM	1.000	PC	RC1242A0	D=10 CLOSED CAP	2.000	PC	TB1402A0	TB2820A-DETE RGENT CIRCUIT-FILTE R PIPE	1.000	PC	TB2821A0	EPDM 6X10 L=40MM PIPE	6.000	PC	TB3004A0	TB2820A L=550mm EPDM BLACK PIPE	1.000	PC	TB3469A0		1.000	PC	VI1220A1	4,2x12 TCB SELF-TAPPIN G SCREW	4.000	PC	VL1019A0	VIBRATION DETERGENT PUMP	1.000	PC	VL1047A1	D6 PIPE HOLDER - D8 J.G. TERMINAL	1.000	PC
Code	Description	Qty	UOM																																																											
0H2427A0	XECC WASHING CIRCUIT HOLDING PLATE	1.000	PC																																																											
EL1440A0	WATER SELF CLEANING VALVE	1.000	PC																																																											
GN1526A0	INT. D.=6.9 TH=1.8 O-RIN	3.000	PC																																																											
RC1018A0	ZINC PLATED D12 ELASTIC CLAMP	1.000	PC																																																											
RC1019A0	D=10 ELASTIC CLAMP	14.000	PC																																																											
RC1130A0	130x2.6 CLAM	1.000	PC																																																											
RC1242A0	D=10 CLOSED CAP	2.000	PC																																																											
TB1402A0	TB2820A-DETE RGENT CIRCUIT-FILTE R PIPE	1.000	PC																																																											
TB2821A0	EPDM 6X10 L=40MM PIPE	6.000	PC																																																											
TB3004A0	TB2820A L=550mm EPDM BLACK PIPE	1.000	PC																																																											
TB3469A0		1.000	PC																																																											
VI1220A1	4,2x12 TCB SELF-TAPPIN G SCREW	4.000	PC																																																											
VL1019A0	VIBRATION DETERGENT PUMP	1.000	PC																																																											
VL1047A1	D6 PIPE HOLDER - D8 J.G. TERMINAL	1.000	PC																																																											



COMPONENT			SPARE PART																																																			
Code	Description	Image	Code	Description	Kit components																																																	
EL1440A	WATER SELF CLEANING VALVE		KVL1211A	ONE COMPACT AND 0523-EP WASH. SYSTEM KIT	<table border="1"> <thead> <tr> <th>Code</th> <th>Description</th> <th>Qty</th> <th>UOM</th> </tr> </thead> <tbody> <tr> <td>VL1054B0</td> <td>ONE WASHING SYS INLET DISTRIBUTOR</td> <td>1.000</td> <td>PC</td> </tr> <tr> <td>VL1102A1</td> <td>DETERGENT LINE FILTER + BARBED VNR 6 MM</td> <td>1.000</td> <td>PC</td> </tr> <tr> <td>VL1128A1</td> <td>D6 BARBED CHECK VALVE</td> <td>2.000</td> <td>PC</td> </tr> <tr> <td>VL1165A0</td> <td>BAM-BB6 STRAIGHT FITTING</td> <td>1.000</td> <td>PC</td> </tr> <tr> <td>VL1166A0</td> <td>BB6-AR6 L FITTING</td> <td>1.000</td> <td>PC</td> </tr> <tr> <td>VL1174C0</td> <td>D1.2 MM CALIBRATED D1.2 MM</td> <td>1.000</td> <td>PC</td> </tr> <tr> <td>VL1191A0</td> <td>ONE WASHING DISTRIBUTOR OUTLETS KIT</td> <td>1.000</td> <td>PC</td> </tr> <tr> <td>VM2172A0</td> <td>LOCKING CLIP FOR PUMP WITH CIRCUIT</td> <td>2.000</td> <td>PC</td> </tr> </tbody> </table>	Code	Description	Qty	UOM	VL1054B0	ONE WASHING SYS INLET DISTRIBUTOR	1.000	PC	VL1102A1	DETERGENT LINE FILTER + BARBED VNR 6 MM	1.000	PC	VL1128A1	D6 BARBED CHECK VALVE	2.000	PC	VL1165A0	BAM-BB6 STRAIGHT FITTING	1.000	PC	VL1166A0	BB6-AR6 L FITTING	1.000	PC	VL1174C0	D1.2 MM CALIBRATED D1.2 MM	1.000	PC	VL1191A0	ONE WASHING DISTRIBUTOR OUTLETS KIT	1.000	PC	VM2172A0	LOCKING CLIP FOR PUMP WITH CIRCUIT	2.000	PC													
			Code	Description	Qty	UOM																																																
VL1054B0	ONE WASHING SYS INLET DISTRIBUTOR	1.000	PC																																																			
VL1102A1	DETERGENT LINE FILTER + BARBED VNR 6 MM	1.000	PC																																																			
VL1128A1	D6 BARBED CHECK VALVE	2.000	PC																																																			
VL1165A0	BAM-BB6 STRAIGHT FITTING	1.000	PC																																																			
VL1166A0	BB6-AR6 L FITTING	1.000	PC																																																			
VL1174C0	D1.2 MM CALIBRATED D1.2 MM	1.000	PC																																																			
VL1191A0	ONE WASHING DISTRIBUTOR OUTLETS KIT	1.000	PC																																																			
VM2172A0	LOCKING CLIP FOR PUMP WITH CIRCUIT	2.000	PC																																																			
KVL1198A	MM EU HOOD CLEANING SYSTEM KIT	<table border="1"> <thead> <tr> <th>Code</th> <th>Description</th> <th>Qty</th> <th>UOM</th> </tr> </thead> <tbody> <tr> <td>0H2213A1</td> <td>HOOD WATER CIRCUIT PLAT</td> <td>1.000</td> <td>PC</td> </tr> <tr> <td>EL1440A0</td> <td>WATER SELF CLEANING VALVE</td> <td>2.000</td> <td>PC</td> </tr> <tr> <td>GN1526A0</td> <td>INT. D.=6.9 TH=1.8 O-RIN</td> <td>5.000</td> <td>PC</td> </tr> <tr> <td>RC1018A0</td> <td>ZINC PLATED D12 ELASTIC CLAMP</td> <td>4.000</td> <td>PC</td> </tr> <tr> <td>RC1019A0</td> <td>D=10 ELASTIC CLAMP</td> <td>16.000</td> <td>PC</td> </tr> <tr> <td>RC1131A0</td> <td>200x2.6 BLACK CLAMP</td> <td>1.000</td> <td>PC</td> </tr> <tr> <td>RC1242A0</td> <td>D=10 CLOSED CAP</td> <td>2.000</td> <td>PC</td> </tr> <tr> <td>TB2821A0</td> <td>EPDM 6X10 L=40MM PIPE</td> <td>6.000</td> <td>PC</td> </tr> <tr> <td>TB2994A0</td> <td>HOOD DETERGENT PIPE</td> <td>2.000</td> <td>PC</td> </tr> <tr> <td>TB3252A0</td> <td>TB3252A0</td> <td>2.000</td> <td>PC</td> </tr> <tr> <td>V11220A1</td> <td>4,2x12 TCB SELF-TAPPIN G SCREW</td> <td>3.000</td> <td>PC</td> </tr> <tr> <td>VL1019A0</td> <td>VIBRATION DETERGENT PUMP</td> <td>1.000</td> <td>PC</td> </tr> </tbody> </table>	Code	Description	Qty	UOM	0H2213A1	HOOD WATER CIRCUIT PLAT	1.000	PC	EL1440A0	WATER SELF CLEANING VALVE	2.000	PC	GN1526A0	INT. D.=6.9 TH=1.8 O-RIN	5.000	PC	RC1018A0	ZINC PLATED D12 ELASTIC CLAMP	4.000	PC	RC1019A0	D=10 ELASTIC CLAMP	16.000	PC	RC1131A0	200x2.6 BLACK CLAMP	1.000	PC	RC1242A0	D=10 CLOSED CAP	2.000	PC	TB2821A0	EPDM 6X10 L=40MM PIPE	6.000	PC	TB2994A0	HOOD DETERGENT PIPE	2.000	PC	TB3252A0	TB3252A0	2.000	PC	V11220A1	4,2x12 TCB SELF-TAPPIN G SCREW	3.000	PC	VL1019A0	VIBRATION DETERGENT PUMP	1.000	PC
Code	Description	Qty	UOM																																																			
0H2213A1	HOOD WATER CIRCUIT PLAT	1.000	PC																																																			
EL1440A0	WATER SELF CLEANING VALVE	2.000	PC																																																			
GN1526A0	INT. D.=6.9 TH=1.8 O-RIN	5.000	PC																																																			
RC1018A0	ZINC PLATED D12 ELASTIC CLAMP	4.000	PC																																																			
RC1019A0	D=10 ELASTIC CLAMP	16.000	PC																																																			
RC1131A0	200x2.6 BLACK CLAMP	1.000	PC																																																			
RC1242A0	D=10 CLOSED CAP	2.000	PC																																																			
TB2821A0	EPDM 6X10 L=40MM PIPE	6.000	PC																																																			
TB2994A0	HOOD DETERGENT PIPE	2.000	PC																																																			
TB3252A0	TB3252A0	2.000	PC																																																			
V11220A1	4,2x12 TCB SELF-TAPPIN G SCREW	3.000	PC																																																			
VL1019A0	VIBRATION DETERGENT PUMP	1.000	PC																																																			



COMPONENT			SPARE PART																																																																																					
Code	Description	Image	Code	Description	Kit components																																																																																			
EL1440A	WATER SELF CLEANING VALVE		KVL1198A	MM EU HOOD CLEANING SYSTEM KIT	<table border="1"> <thead> <tr> <th>Code</th> <th>Description</th> <th>Qty</th> <th>UOM</th> </tr> </thead> <tbody> <tr> <td>VL1047A1</td> <td>D6 PIPE HOLDER - D8 J.G. TERMINAL</td> <td>2.000</td> <td>PC</td> </tr> <tr> <td>VL1054B0</td> <td>ONE WASHING SYS INLET DISTRIBUTOR</td> <td>1.000</td> <td>PC</td> </tr> <tr> <td>VL1102A1</td> <td>DETERGENT LINE FILTER + BARBED VNR 6 MM</td> <td>1.000</td> <td>PC</td> </tr> <tr> <td>VL1127A1</td> <td>6mm BARBED T-SHAPED FITTING</td> <td>1.000</td> <td>PC</td> </tr> <tr> <td>VL1128A1</td> <td>D6 BARBED CHECK VALVE</td> <td>2.000</td> <td>PC</td> </tr> <tr> <td>VL1165A0</td> <td>BAM-BB6 STRAIGHT FITTING</td> <td>1.000</td> <td>PC</td> </tr> <tr> <td>VL1166A0</td> <td>BB6-AR6 L FITTING</td> <td>2.000</td> <td>PC</td> </tr> <tr> <td>VL1174C0</td> <td>D1.2 MM CALIBRATED D1.2 MM</td> <td>1.000</td> <td>PC</td> </tr> <tr> <td>VL1191A0</td> <td>ONE WASHING DISTRIBUTOR OUTLETS KIT</td> <td>1.000</td> <td>PC</td> </tr> <tr> <td>VL1214A0</td> <td>BAYONET - 6mm BARBED NRV VALVE</td> <td>1.000</td> <td>PC</td> </tr> <tr> <td>VM1605A0</td> <td>CLIP TWIST LOCK DIAM. 10,2-12,7 MM</td> <td>2.000</td> <td>PC</td> </tr> <tr> <td>VM2172A0</td> <td>LOCKING CLIP FOR PUMP WITH CIRCUIT</td> <td>5.000</td> <td>PC</td> </tr> </tbody> </table>	Code	Description	Qty	UOM	VL1047A1	D6 PIPE HOLDER - D8 J.G. TERMINAL	2.000	PC	VL1054B0	ONE WASHING SYS INLET DISTRIBUTOR	1.000	PC	VL1102A1	DETERGENT LINE FILTER + BARBED VNR 6 MM	1.000	PC	VL1127A1	6mm BARBED T-SHAPED FITTING	1.000	PC	VL1128A1	D6 BARBED CHECK VALVE	2.000	PC	VL1165A0	BAM-BB6 STRAIGHT FITTING	1.000	PC	VL1166A0	BB6-AR6 L FITTING	2.000	PC	VL1174C0	D1.2 MM CALIBRATED D1.2 MM	1.000	PC	VL1191A0	ONE WASHING DISTRIBUTOR OUTLETS KIT	1.000	PC	VL1214A0	BAYONET - 6mm BARBED NRV VALVE	1.000	PC	VM1605A0	CLIP TWIST LOCK DIAM. 10,2-12,7 MM	2.000	PC	VM2172A0	LOCKING CLIP FOR PUMP WITH CIRCUIT	5.000	PC	KVL1187A	3 ROTOR ARMS PLUS EU CLEANING SYSTEM KIT	<table border="1"> <thead> <tr> <th>Code</th> <th>Description</th> <th>Qty</th> <th>UOM</th> </tr> </thead> <tbody> <tr> <td>0H2354A1</td> <td>XEVC-XEVL PLUS WASHING CIRCUIT PLAT</td> <td>1.000</td> <td>PC</td> </tr> <tr> <td>EL1440A0</td> <td>WATER SELF CLEANING VALVE</td> <td>4.000</td> <td>PC</td> </tr> <tr> <td>GN1526A0</td> <td>INT. D.=6.9 TH=1.8 O-RIN</td> <td>9.000</td> <td>PC</td> </tr> <tr> <td>RC1018A0</td> <td>ZINC PLATED D12 ELASTIC CLAMP</td> <td>11.000</td> <td>PC</td> </tr> <tr> <td>RC1019A0</td> <td>D=10 ELASTIC CLAMP</td> <td>16.000</td> <td>PC</td> </tr> <tr> <td>RC1130A0</td> <td>130x2,6 CLAM</td> <td>1.000</td> <td>PC</td> </tr> </tbody> </table>	Code	Description	Qty	UOM	0H2354A1	XEVC-XEVL PLUS WASHING CIRCUIT PLAT	1.000	PC	EL1440A0	WATER SELF CLEANING VALVE	4.000	PC	GN1526A0	INT. D.=6.9 TH=1.8 O-RIN	9.000	PC	RC1018A0	ZINC PLATED D12 ELASTIC CLAMP	11.000	PC	RC1019A0	D=10 ELASTIC CLAMP	16.000	PC	RC1130A0	130x2,6 CLAM	1.000	PC
			Code	Description	Qty	UOM																																																																																		
VL1047A1	D6 PIPE HOLDER - D8 J.G. TERMINAL	2.000	PC																																																																																					
VL1054B0	ONE WASHING SYS INLET DISTRIBUTOR	1.000	PC																																																																																					
VL1102A1	DETERGENT LINE FILTER + BARBED VNR 6 MM	1.000	PC																																																																																					
VL1127A1	6mm BARBED T-SHAPED FITTING	1.000	PC																																																																																					
VL1128A1	D6 BARBED CHECK VALVE	2.000	PC																																																																																					
VL1165A0	BAM-BB6 STRAIGHT FITTING	1.000	PC																																																																																					
VL1166A0	BB6-AR6 L FITTING	2.000	PC																																																																																					
VL1174C0	D1.2 MM CALIBRATED D1.2 MM	1.000	PC																																																																																					
VL1191A0	ONE WASHING DISTRIBUTOR OUTLETS KIT	1.000	PC																																																																																					
VL1214A0	BAYONET - 6mm BARBED NRV VALVE	1.000	PC																																																																																					
VM1605A0	CLIP TWIST LOCK DIAM. 10,2-12,7 MM	2.000	PC																																																																																					
VM2172A0	LOCKING CLIP FOR PUMP WITH CIRCUIT	5.000	PC																																																																																					
Code	Description	Qty	UOM																																																																																					
0H2354A1	XEVC-XEVL PLUS WASHING CIRCUIT PLAT	1.000	PC																																																																																					
EL1440A0	WATER SELF CLEANING VALVE	4.000	PC																																																																																					
GN1526A0	INT. D.=6.9 TH=1.8 O-RIN	9.000	PC																																																																																					
RC1018A0	ZINC PLATED D12 ELASTIC CLAMP	11.000	PC																																																																																					
RC1019A0	D=10 ELASTIC CLAMP	16.000	PC																																																																																					
RC1130A0	130x2,6 CLAM	1.000	PC																																																																																					



COMPONENT			SPARE PART																																																																																						
Code	Description	Image	Code	Description	Kit components																																																																																				
EL1440A	WATER SELF CLEANING VALVE		KVL1187A	3 ROTOR ARMS PLUS EU CLEANING SYSTEM KIT	<table border="1"> <thead> <tr> <th>Code</th> <th>Description</th> <th>Qty</th> <th>UOM</th> </tr> </thead> <tbody> <tr> <td>RC1131A0</td> <td>200x2.6 BLACK CLAMP</td> <td>3.000</td> <td>PC</td> </tr> <tr> <td>RC1242A0</td> <td>D=10 CLOSED CAP</td> <td>2.000</td> <td>PC</td> </tr> <tr> <td>RC1356A0</td> <td>"STRAIGHT THREADED FEMALE END 8x1/4" BS</td> <td>1.000</td> <td>PC</td> </tr> <tr> <td>TB2652A0</td> <td></td> <td>1.000</td> <td>PC</td> </tr> <tr> <td>TB2677A0</td> <td></td> <td>1.000</td> <td>PC</td> </tr> <tr> <td>TB2821A0</td> <td>EPDM 6X10 L=40MM PIPE</td> <td>6.000</td> <td>PC</td> </tr> <tr> <td>TB3004A0</td> <td>TB2820A L=550mm EPDM BLACK PIPE</td> <td>2.000</td> <td>PC</td> </tr> <tr> <td>TB3024C0</td> <td></td> <td>3.000</td> <td>PC</td> </tr> <tr> <td>TB3226A0</td> <td></td> <td>1.000</td> <td>PC</td> </tr> <tr> <td>TB3440A0</td> <td>TB3132A L=1050mm EPDM WHITE-BLUE PIPE</td> <td>1.000</td> <td>PC</td> </tr> <tr> <td>VL1019A0</td> <td>VIBRATION DETERGENT PUMP</td> <td>1.000</td> <td>PC</td> </tr> <tr> <td>VL1047A1</td> <td>D6 PIPE HOLDER - D8 J.G. TERMINAL</td> <td>1.000</td> <td>PC</td> </tr> <tr> <td>VL1065A1</td> <td>1/4 MALE N.O. PRESSURE SWITCH</td> <td>1.000</td> <td>PC</td> </tr> <tr> <td>VL1102A1</td> <td>DETERGENT LINE FILTER + BARBED VNR 6 MM</td> <td>1.000</td> <td>PC</td> </tr> <tr> <td>VL1127A1</td> <td>6mm BARBED T-SHAPED FITTING</td> <td>2.000</td> <td>PC</td> </tr> <tr> <td>VL1128A1</td> <td>D6 BARBED CHECK VALVE</td> <td>3.000</td> <td>PC</td> </tr> <tr> <td>VL1166A0</td> <td>BB6-AR6 L FITTING</td> <td>4.000</td> <td>PC</td> </tr> <tr> <td>VL1167A2</td> <td>GN21 3 ROTOR ARMS B-B FLOW RESTRICTOR</td> <td>1.000</td> <td>PC</td> </tr> <tr> <td>VL1174C0</td> <td>D1.2 MM CALIBRATED D1.2 MM</td> <td>1.000</td> <td>PC</td> </tr> <tr> <td>VL1186A0</td> <td>3 WAYS PLUS WASHING DISTRIBUTOR</td> <td>1.000</td> <td>PC</td> </tr> </tbody> </table>	Code	Description	Qty	UOM	RC1131A0	200x2.6 BLACK CLAMP	3.000	PC	RC1242A0	D=10 CLOSED CAP	2.000	PC	RC1356A0	"STRAIGHT THREADED FEMALE END 8x1/4" BS	1.000	PC	TB2652A0		1.000	PC	TB2677A0		1.000	PC	TB2821A0	EPDM 6X10 L=40MM PIPE	6.000	PC	TB3004A0	TB2820A L=550mm EPDM BLACK PIPE	2.000	PC	TB3024C0		3.000	PC	TB3226A0		1.000	PC	TB3440A0	TB3132A L=1050mm EPDM WHITE-BLUE PIPE	1.000	PC	VL1019A0	VIBRATION DETERGENT PUMP	1.000	PC	VL1047A1	D6 PIPE HOLDER - D8 J.G. TERMINAL	1.000	PC	VL1065A1	1/4 MALE N.O. PRESSURE SWITCH	1.000	PC	VL1102A1	DETERGENT LINE FILTER + BARBED VNR 6 MM	1.000	PC	VL1127A1	6mm BARBED T-SHAPED FITTING	2.000	PC	VL1128A1	D6 BARBED CHECK VALVE	3.000	PC	VL1166A0	BB6-AR6 L FITTING	4.000	PC	VL1167A2	GN21 3 ROTOR ARMS B-B FLOW RESTRICTOR	1.000	PC	VL1174C0	D1.2 MM CALIBRATED D1.2 MM	1.000	PC	VL1186A0	3 WAYS PLUS WASHING DISTRIBUTOR	1.000	PC
Code	Description	Qty	UOM																																																																																						
RC1131A0	200x2.6 BLACK CLAMP	3.000	PC																																																																																						
RC1242A0	D=10 CLOSED CAP	2.000	PC																																																																																						
RC1356A0	"STRAIGHT THREADED FEMALE END 8x1/4" BS	1.000	PC																																																																																						
TB2652A0		1.000	PC																																																																																						
TB2677A0		1.000	PC																																																																																						
TB2821A0	EPDM 6X10 L=40MM PIPE	6.000	PC																																																																																						
TB3004A0	TB2820A L=550mm EPDM BLACK PIPE	2.000	PC																																																																																						
TB3024C0		3.000	PC																																																																																						
TB3226A0		1.000	PC																																																																																						
TB3440A0	TB3132A L=1050mm EPDM WHITE-BLUE PIPE	1.000	PC																																																																																						
VL1019A0	VIBRATION DETERGENT PUMP	1.000	PC																																																																																						
VL1047A1	D6 PIPE HOLDER - D8 J.G. TERMINAL	1.000	PC																																																																																						
VL1065A1	1/4 MALE N.O. PRESSURE SWITCH	1.000	PC																																																																																						
VL1102A1	DETERGENT LINE FILTER + BARBED VNR 6 MM	1.000	PC																																																																																						
VL1127A1	6mm BARBED T-SHAPED FITTING	2.000	PC																																																																																						
VL1128A1	D6 BARBED CHECK VALVE	3.000	PC																																																																																						
VL1166A0	BB6-AR6 L FITTING	4.000	PC																																																																																						
VL1167A2	GN21 3 ROTOR ARMS B-B FLOW RESTRICTOR	1.000	PC																																																																																						
VL1174C0	D1.2 MM CALIBRATED D1.2 MM	1.000	PC																																																																																						
VL1186A0	3 WAYS PLUS WASHING DISTRIBUTOR	1.000	PC																																																																																						





COMPONENT			SPARE PART																																																							
Code	Description	Image	Code	Description	Kit components																																																					
EL1440A	WATER SELF CLEANING VALVE		KVL1187A	3 ROTOR ARMS PLUS EU CLEANING SYSTEM KIT	<table border="1"> <thead> <tr> <th>Code</th> <th>Description</th> <th>Qty</th> <th>UOM</th> </tr> </thead> <tbody> <tr> <td>VL1190A0</td> <td>PLUS WASHING SYSTEM INLET DISTRIBUTOR</td> <td>1.000</td> <td>PC</td> </tr> <tr> <td>VL1214A0</td> <td>BAYONET - 6mm BARBED NRV VALVE</td> <td>1.000</td> <td>PC</td> </tr> <tr> <td>VM1605A0</td> <td>CLIP TWIST LOCK DIAM. 10,2-12,7 MM</td> <td>3.000</td> <td>PC</td> </tr> <tr> <td>VM2172A0</td> <td>LOCKING CLIP FOR PUMP WITH CIRCUIT</td> <td>5.000</td> <td>PC</td> </tr> </tbody> </table>	Code	Description	Qty	UOM	VL1190A0	PLUS WASHING SYSTEM INLET DISTRIBUTOR	1.000	PC	VL1214A0	BAYONET - 6mm BARBED NRV VALVE	1.000	PC	VM1605A0	CLIP TWIST LOCK DIAM. 10,2-12,7 MM	3.000	PC	VM2172A0	LOCKING CLIP FOR PUMP WITH CIRCUIT	5.000	PC																																	
			Code	Description	Qty	UOM																																																				
VL1190A0	PLUS WASHING SYSTEM INLET DISTRIBUTOR	1.000	PC																																																							
VL1214A0	BAYONET - 6mm BARBED NRV VALVE	1.000	PC																																																							
VM1605A0	CLIP TWIST LOCK DIAM. 10,2-12,7 MM	3.000	PC																																																							
VM2172A0	LOCKING CLIP FOR PUMP WITH CIRCUIT	5.000	PC																																																							
KVL1184A	2 ROTOR ARMS PLUS EU CLEANING SYSTEM KIT	<table border="1"> <thead> <tr> <th>Code</th> <th>Description</th> <th>Qty</th> <th>UOM</th> </tr> </thead> <tbody> <tr> <td>0H2354A1</td> <td>XEVC-XEVL PLUS WASHING CIRCUIT PLAT</td> <td>1.000</td> <td>PC</td> </tr> <tr> <td>EL1440A0</td> <td>WATER SELF CLEANING VALVE</td> <td>4.000</td> <td>PC</td> </tr> <tr> <td>GN1526A0</td> <td>INT. D.=6.9 TH=1.8 O-RIN</td> <td>9.000</td> <td>PC</td> </tr> <tr> <td>RC1018A0</td> <td>ZINC PLATED D12 ELASTIC CLAMP</td> <td>3.000</td> <td>PC</td> </tr> <tr> <td>RC1019A0</td> <td>D=10 ELASTIC CLAMP</td> <td>15.000</td> <td>PC</td> </tr> <tr> <td>RC1130A0</td> <td>130x2.6 CLAM</td> <td>1.000</td> <td>PC</td> </tr> <tr> <td>RC1131A0</td> <td>200x2.6 BLACK CLAMP</td> <td>3.000</td> <td>PC</td> </tr> <tr> <td>RC1242A0</td> <td>D=10 CLOSED CAP</td> <td>2.000</td> <td>PC</td> </tr> <tr> <td>RC1356A0</td> <td>"STRAIGHT THREADED FEMALE END 8x1/4" BS</td> <td>1.000</td> <td>PC</td> </tr> <tr> <td>TB2821A0</td> <td>EPDM 6X10 L=40MM PIPE</td> <td>6.000</td> <td>PC</td> </tr> <tr> <td>TB2994A0</td> <td>HOOD DETERGENT PIPE</td> <td>1.000</td> <td>PC</td> </tr> <tr> <td>TB3004A0</td> <td>TB2820A L=550mm EPDM BLACK PIPE</td> <td>2.000</td> <td>PC</td> </tr> <tr> <td>TB3005B0</td> <td>TB3132A L=550mm EPDM WHITE-BLUE PIPE</td> <td>1.000</td> <td>PC</td> </tr> </tbody> </table>	Code	Description	Qty	UOM	0H2354A1	XEVC-XEVL PLUS WASHING CIRCUIT PLAT	1.000	PC	EL1440A0	WATER SELF CLEANING VALVE	4.000	PC	GN1526A0	INT. D.=6.9 TH=1.8 O-RIN	9.000	PC	RC1018A0	ZINC PLATED D12 ELASTIC CLAMP	3.000	PC	RC1019A0	D=10 ELASTIC CLAMP	15.000	PC	RC1130A0	130x2.6 CLAM	1.000	PC	RC1131A0	200x2.6 BLACK CLAMP	3.000	PC	RC1242A0	D=10 CLOSED CAP	2.000	PC	RC1356A0	"STRAIGHT THREADED FEMALE END 8x1/4" BS	1.000	PC	TB2821A0	EPDM 6X10 L=40MM PIPE	6.000	PC	TB2994A0	HOOD DETERGENT PIPE	1.000	PC	TB3004A0	TB2820A L=550mm EPDM BLACK PIPE	2.000	PC	TB3005B0	TB3132A L=550mm EPDM WHITE-BLUE PIPE	1.000	PC
Code	Description	Qty	UOM																																																							
0H2354A1	XEVC-XEVL PLUS WASHING CIRCUIT PLAT	1.000	PC																																																							
EL1440A0	WATER SELF CLEANING VALVE	4.000	PC																																																							
GN1526A0	INT. D.=6.9 TH=1.8 O-RIN	9.000	PC																																																							
RC1018A0	ZINC PLATED D12 ELASTIC CLAMP	3.000	PC																																																							
RC1019A0	D=10 ELASTIC CLAMP	15.000	PC																																																							
RC1130A0	130x2.6 CLAM	1.000	PC																																																							
RC1131A0	200x2.6 BLACK CLAMP	3.000	PC																																																							
RC1242A0	D=10 CLOSED CAP	2.000	PC																																																							
RC1356A0	"STRAIGHT THREADED FEMALE END 8x1/4" BS	1.000	PC																																																							
TB2821A0	EPDM 6X10 L=40MM PIPE	6.000	PC																																																							
TB2994A0	HOOD DETERGENT PIPE	1.000	PC																																																							
TB3004A0	TB2820A L=550mm EPDM BLACK PIPE	2.000	PC																																																							
TB3005B0	TB3132A L=550mm EPDM WHITE-BLUE PIPE	1.000	PC																																																							





COMPONENT			SPARE PART																																																																													
Code	Description	Image	Code	Description	Kit components																																																																											
EL1440A	WATER SELF CLEANING VALVE		KVL1184A	2 ROTOR ARMS PLUS EU CLEANING SYSTEM KIT	<table border="1"> <thead> <tr> <th>Code</th> <th>Description</th> <th>Qty</th> <th>UOM</th> </tr> </thead> <tbody> <tr> <td>TB3440A0</td> <td>TB3132A L=1050mm EPDM WHITE-BLUE PIPE</td> <td>1.000</td> <td>PC</td> </tr> <tr> <td>VL1019A0</td> <td>VIBRATION DETERGENT PUMP</td> <td>1.000</td> <td>PC</td> </tr> <tr> <td>VL1047A1</td> <td>D6 PIPE HOLDER - D8 J.G. TERMINAL</td> <td>1.000</td> <td>PC</td> </tr> <tr> <td>VL1065A1</td> <td>1/4 MALE N.O. PRESSURE SWITCH</td> <td>1.000</td> <td>PC</td> </tr> <tr> <td>VL1102A1</td> <td>DETERGENT LINE FILTER + BARBED VNR 6 MM</td> <td>1.000</td> <td>PC</td> </tr> <tr> <td>VL1128A1</td> <td>D6 BARBED CHECK VALVE</td> <td>2.000</td> <td>PC</td> </tr> <tr> <td>VL1141A1</td> <td>BB6-BB6 STRAIGHT CONNECTION</td> <td>1.000</td> <td>PC</td> </tr> <tr> <td>VL1166A0</td> <td>BB6-AR6 L FITTING</td> <td>4.000</td> <td>PC</td> </tr> <tr> <td>VL1174C0</td> <td>D1.2 MM CALIBRATED D1.2 MM</td> <td>1.000</td> <td>PC</td> </tr> <tr> <td>VL1186A0</td> <td>3 WAYS PLUS WASHING DISTRIBUTOR</td> <td>1.000</td> <td>PC</td> </tr> <tr> <td>VL1190A0</td> <td>PLUS WASHING SYSTEM INLET DISTRIBUTOR</td> <td>1.000</td> <td>PC</td> </tr> <tr> <td>VL1214A0</td> <td>BAYONET - 6mm BARBED NRV VALVE</td> <td>1.000</td> <td>PC</td> </tr> <tr> <td>VM1605A0</td> <td>CLIP TWIST LOCK DIAM. 10.2-12.7 MM</td> <td>3.000</td> <td>PC</td> </tr> <tr> <td>VM2172A0</td> <td>LOCKING CLIP FOR PUMP WITH CIRCUIT</td> <td>5.000</td> <td>PC</td> </tr> </tbody> </table>	Code	Description	Qty	UOM	TB3440A0	TB3132A L=1050mm EPDM WHITE-BLUE PIPE	1.000	PC	VL1019A0	VIBRATION DETERGENT PUMP	1.000	PC	VL1047A1	D6 PIPE HOLDER - D8 J.G. TERMINAL	1.000	PC	VL1065A1	1/4 MALE N.O. PRESSURE SWITCH	1.000	PC	VL1102A1	DETERGENT LINE FILTER + BARBED VNR 6 MM	1.000	PC	VL1128A1	D6 BARBED CHECK VALVE	2.000	PC	VL1141A1	BB6-BB6 STRAIGHT CONNECTION	1.000	PC	VL1166A0	BB6-AR6 L FITTING	4.000	PC	VL1174C0	D1.2 MM CALIBRATED D1.2 MM	1.000	PC	VL1186A0	3 WAYS PLUS WASHING DISTRIBUTOR	1.000	PC	VL1190A0	PLUS WASHING SYSTEM INLET DISTRIBUTOR	1.000	PC	VL1214A0	BAYONET - 6mm BARBED NRV VALVE	1.000	PC	VM1605A0	CLIP TWIST LOCK DIAM. 10.2-12.7 MM	3.000	PC	VM2172A0	LOCKING CLIP FOR PUMP WITH CIRCUIT	5.000	PC	KVL1183A	1 ROTOR ARM PLUS CLEANING SYSTEM KIT	<table border="1"> <thead> <tr> <th>Code</th> <th>Description</th> <th>Qty</th> <th>UOM</th> </tr> </thead> <tbody> <tr> <td>0H2354A1</td> <td>XEVC-XEVL PLUS WASHING CIRCUIT PLAT</td> <td>1.000</td> <td>PC</td> </tr> <tr> <td>EL1440A0</td> <td>WATER SELF CLEANING VALVE</td> <td>3.000</td> <td>PC</td> </tr> </tbody> </table>	Code	Description	Qty	UOM	0H2354A1	XEVC-XEVL PLUS WASHING CIRCUIT PLAT	1.000	PC	EL1440A0	WATER SELF CLEANING VALVE	3.000	PC
			Code	Description	Qty	UOM																																																																										
TB3440A0	TB3132A L=1050mm EPDM WHITE-BLUE PIPE	1.000	PC																																																																													
VL1019A0	VIBRATION DETERGENT PUMP	1.000	PC																																																																													
VL1047A1	D6 PIPE HOLDER - D8 J.G. TERMINAL	1.000	PC																																																																													
VL1065A1	1/4 MALE N.O. PRESSURE SWITCH	1.000	PC																																																																													
VL1102A1	DETERGENT LINE FILTER + BARBED VNR 6 MM	1.000	PC																																																																													
VL1128A1	D6 BARBED CHECK VALVE	2.000	PC																																																																													
VL1141A1	BB6-BB6 STRAIGHT CONNECTION	1.000	PC																																																																													
VL1166A0	BB6-AR6 L FITTING	4.000	PC																																																																													
VL1174C0	D1.2 MM CALIBRATED D1.2 MM	1.000	PC																																																																													
VL1186A0	3 WAYS PLUS WASHING DISTRIBUTOR	1.000	PC																																																																													
VL1190A0	PLUS WASHING SYSTEM INLET DISTRIBUTOR	1.000	PC																																																																													
VL1214A0	BAYONET - 6mm BARBED NRV VALVE	1.000	PC																																																																													
VM1605A0	CLIP TWIST LOCK DIAM. 10.2-12.7 MM	3.000	PC																																																																													
VM2172A0	LOCKING CLIP FOR PUMP WITH CIRCUIT	5.000	PC																																																																													
Code	Description	Qty	UOM																																																																													
0H2354A1	XEVC-XEVL PLUS WASHING CIRCUIT PLAT	1.000	PC																																																																													
EL1440A0	WATER SELF CLEANING VALVE	3.000	PC																																																																													







COMPONENT			SPARE PART																																																																																						
Code	Description	Image	Code	Description	Kit components																																																																																				
EL1440A	WATER SELF CLEANING VALVE		KVL1183A	1 ROTOR ARM PLUS CLEANING SYSTEM KIT	<table border="1"> <thead> <tr> <th>Code</th> <th>Description</th> <th>Qty</th> <th>UOM</th> </tr> </thead> <tbody> <tr> <td>GN1526A0</td> <td>INT. D.=6.9 TH=1.8 O-RIN</td> <td>7.000</td> <td>PC</td> </tr> <tr> <td>RC1018A0</td> <td>ZINC PLATED D12 ELASTIC CLAMP</td> <td>2.000</td> <td>PC</td> </tr> <tr> <td>RC1019A0</td> <td>D=10 ELASTIC CLAMP</td> <td>14.000</td> <td>PC</td> </tr> <tr> <td>RC1130A0</td> <td>130x2.6 CLAM</td> <td>1.000</td> <td>PC</td> </tr> <tr> <td>RC1131A0</td> <td>200x2.6 BLACK CLAMP</td> <td>2.000</td> <td>PC</td> </tr> <tr> <td>RC1242A0</td> <td>D=10 CLOSED CAP</td> <td>2.000</td> <td>PC</td> </tr> <tr> <td>RC1356A0</td> <td>"STRAIGHT THREADED FEMALE END 8x1/4" BS</td> <td>1.000</td> <td>PC</td> </tr> <tr> <td>TB2821A0</td> <td>EPDM 6X10 L=40MM PIPE</td> <td>6.000</td> <td>PC</td> </tr> <tr> <td>TB3004A0</td> <td>TB2820A L=550mm EPDM BLACK PIPE</td> <td>1.000</td> <td>PC</td> </tr> <tr> <td>TB3005B0</td> <td>TB3132A L=550mm EPDM WHITE-BLUE PIPE</td> <td>1.000</td> <td>PC</td> </tr> <tr> <td>TB3225B0</td> <td>TB2820A-TAN K-WASHYNG SYS CONNECTION</td> <td>1.000</td> <td>PC</td> </tr> <tr> <td>TB3252A0</td> <td>TB3252A0</td> <td>1.000</td> <td>PC</td> </tr> <tr> <td>VL1019A0</td> <td>VIBRATION DETERGENT PUMP</td> <td>1.000</td> <td>PC</td> </tr> <tr> <td>VL1047A1</td> <td>D6 PIPE HOLDER - D6 J.G. TERMINAL</td> <td>1.000</td> <td>PC</td> </tr> <tr> <td>VL1065A1</td> <td>1/4 MALE N.O. PRESSURE SWITCH</td> <td>1.000</td> <td>PC</td> </tr> <tr> <td>VL1102A1</td> <td>DETERGENT LINE FILTER + BARBED VNR 6 MM</td> <td>1.000</td> <td>PC</td> </tr> <tr> <td>VL1128A1</td> <td>D6 BARBED CHECK VALVE</td> <td>2.000</td> <td>PC</td> </tr> <tr> <td>VL1166A0</td> <td>BB6-AR6 L FITTING</td> <td>3.000</td> <td>PC</td> </tr> <tr> <td>VL1174C0</td> <td>D1.2 MM CALIBRATED D1.2 MM</td> <td>1.000</td> <td>PC</td> </tr> <tr> <td>VL1185A0</td> <td>2 WAYS PLUS WASHING DISTRIBUTOR</td> <td>1.000</td> <td>PC</td> </tr> </tbody> </table>	Code	Description	Qty	UOM	GN1526A0	INT. D.=6.9 TH=1.8 O-RIN	7.000	PC	RC1018A0	ZINC PLATED D12 ELASTIC CLAMP	2.000	PC	RC1019A0	D=10 ELASTIC CLAMP	14.000	PC	RC1130A0	130x2.6 CLAM	1.000	PC	RC1131A0	200x2.6 BLACK CLAMP	2.000	PC	RC1242A0	D=10 CLOSED CAP	2.000	PC	RC1356A0	"STRAIGHT THREADED FEMALE END 8x1/4" BS	1.000	PC	TB2821A0	EPDM 6X10 L=40MM PIPE	6.000	PC	TB3004A0	TB2820A L=550mm EPDM BLACK PIPE	1.000	PC	TB3005B0	TB3132A L=550mm EPDM WHITE-BLUE PIPE	1.000	PC	TB3225B0	TB2820A-TAN K-WASHYNG SYS CONNECTION	1.000	PC	TB3252A0	TB3252A0	1.000	PC	VL1019A0	VIBRATION DETERGENT PUMP	1.000	PC	VL1047A1	D6 PIPE HOLDER - D6 J.G. TERMINAL	1.000	PC	VL1065A1	1/4 MALE N.O. PRESSURE SWITCH	1.000	PC	VL1102A1	DETERGENT LINE FILTER + BARBED VNR 6 MM	1.000	PC	VL1128A1	D6 BARBED CHECK VALVE	2.000	PC	VL1166A0	BB6-AR6 L FITTING	3.000	PC	VL1174C0	D1.2 MM CALIBRATED D1.2 MM	1.000	PC	VL1185A0	2 WAYS PLUS WASHING DISTRIBUTOR	1.000	PC
					Code	Description	Qty	UOM																																																																																	
					GN1526A0	INT. D.=6.9 TH=1.8 O-RIN	7.000	PC																																																																																	
					RC1018A0	ZINC PLATED D12 ELASTIC CLAMP	2.000	PC																																																																																	
					RC1019A0	D=10 ELASTIC CLAMP	14.000	PC																																																																																	
					RC1130A0	130x2.6 CLAM	1.000	PC																																																																																	
					RC1131A0	200x2.6 BLACK CLAMP	2.000	PC																																																																																	
					RC1242A0	D=10 CLOSED CAP	2.000	PC																																																																																	
					RC1356A0	"STRAIGHT THREADED FEMALE END 8x1/4" BS	1.000	PC																																																																																	
					TB2821A0	EPDM 6X10 L=40MM PIPE	6.000	PC																																																																																	
					TB3004A0	TB2820A L=550mm EPDM BLACK PIPE	1.000	PC																																																																																	
					TB3005B0	TB3132A L=550mm EPDM WHITE-BLUE PIPE	1.000	PC																																																																																	
					TB3225B0	TB2820A-TAN K-WASHYNG SYS CONNECTION	1.000	PC																																																																																	
					TB3252A0	TB3252A0	1.000	PC																																																																																	
					VL1019A0	VIBRATION DETERGENT PUMP	1.000	PC																																																																																	
					VL1047A1	D6 PIPE HOLDER - D6 J.G. TERMINAL	1.000	PC																																																																																	
					VL1065A1	1/4 MALE N.O. PRESSURE SWITCH	1.000	PC																																																																																	
					VL1102A1	DETERGENT LINE FILTER + BARBED VNR 6 MM	1.000	PC																																																																																	
					VL1128A1	D6 BARBED CHECK VALVE	2.000	PC																																																																																	
					VL1166A0	BB6-AR6 L FITTING	3.000	PC																																																																																	
VL1174C0	D1.2 MM CALIBRATED D1.2 MM	1.000	PC																																																																																						
VL1185A0	2 WAYS PLUS WASHING DISTRIBUTOR	1.000	PC																																																																																						

COMPONENT			SPARE PART																																																							
Code	Description	Image	Code	Description	Kit components																																																					
EL1440A	WATER SELF CLEANING VALVE		KVL1183A	1 ROTOR ARM PLUS CLEANING SYSTEM KIT	<table border="1"> <thead> <tr> <th>Code</th> <th>Description</th> <th>Qty</th> <th>UOM</th> </tr> </thead> <tbody> <tr> <td>VL1190A0</td> <td>PLUS WASHING SYSTEM INLET DISTRIBUTOR</td> <td>1.000</td> <td>PC</td> </tr> <tr> <td>VL1214A0</td> <td>BAYONET - 6mm BARBED NRV VALVE</td> <td>1.000</td> <td>PC</td> </tr> <tr> <td>VM1605A0</td> <td>CLIP TWIST LOCK DIAM. 10,2-12,7 MM</td> <td>3.000</td> <td>PC</td> </tr> <tr> <td>VM2172A0</td> <td>LOCKING CLIP FOR PUMP WITH CIRCUIT</td> <td>4.000</td> <td>PC</td> </tr> </tbody> </table>	Code	Description	Qty	UOM	VL1190A0	PLUS WASHING SYSTEM INLET DISTRIBUTOR	1.000	PC	VL1214A0	BAYONET - 6mm BARBED NRV VALVE	1.000	PC	VM1605A0	CLIP TWIST LOCK DIAM. 10,2-12,7 MM	3.000	PC	VM2172A0	LOCKING CLIP FOR PUMP WITH CIRCUIT	4.000	PC																																	
			Code	Description	Qty	UOM																																																				
VL1190A0	PLUS WASHING SYSTEM INLET DISTRIBUTOR	1.000	PC																																																							
VL1214A0	BAYONET - 6mm BARBED NRV VALVE	1.000	PC																																																							
VM1605A0	CLIP TWIST LOCK DIAM. 10,2-12,7 MM	3.000	PC																																																							
VM2172A0	LOCKING CLIP FOR PUMP WITH CIRCUIT	4.000	PC																																																							
KVL1182A	ONE 1ROT CLEANING SYSTEM KIT (0311 EXC.)	<table border="1"> <thead> <tr> <th>Code</th> <th>Description</th> <th>Qty</th> <th>UOM</th> </tr> </thead> <tbody> <tr> <td>0H2202A1</td> <td>ONE WASHING WITH STEAM VALVE SUPPORT</td> <td>1.000</td> <td>PC</td> </tr> <tr> <td>EL1440A0</td> <td>WATER SELF CLEANING VALVE</td> <td>1.000</td> <td>PC</td> </tr> <tr> <td>GN1526A0</td> <td>INT. D.=6.9 TH=1.8 O-RIN</td> <td>3.000</td> <td>PC</td> </tr> <tr> <td>RC1018A0</td> <td>ZINC PLATED D12 ELASTIC CLAMP</td> <td>1.000</td> <td>PC</td> </tr> <tr> <td>RC1019A0</td> <td>D=10 ELASTIC CLAMP</td> <td>14.000</td> <td>PC</td> </tr> <tr> <td>RC1130A0</td> <td>130x2,6 CLAM</td> <td>2.000</td> <td>PC</td> </tr> <tr> <td>RC1242A0</td> <td>D=10 CLOSED CAP</td> <td>2.000</td> <td>PC</td> </tr> <tr> <td>TB2821A0</td> <td>EPDM 6X10 L=40MM PIPE</td> <td>6.000</td> <td>PC</td> </tr> <tr> <td>TB3004A0</td> <td>TB2820A L=550mm EPDM BLACK PIPE</td> <td>1.000</td> <td>PC</td> </tr> <tr> <td>TB3009B0</td> <td>TB3132A-ONE OVEN WASHING INLET</td> <td>1.000</td> <td>PC</td> </tr> <tr> <td>TB3225B0</td> <td>TB2820A-TAN K-WASHYNG SYS CONNECTION</td> <td>1.000</td> <td>PC</td> </tr> <tr> <td>VI1220A1</td> <td>4,2x12 TCB SELF-TAPPIN G SCREW</td> <td>1.000</td> <td>PC</td> </tr> <tr> <td>VL1019A0</td> <td>VIBRATION DETERGENT PUMP</td> <td>1.000</td> <td>PC</td> </tr> </tbody> </table>	Code	Description	Qty	UOM	0H2202A1	ONE WASHING WITH STEAM VALVE SUPPORT	1.000	PC	EL1440A0	WATER SELF CLEANING VALVE	1.000	PC	GN1526A0	INT. D.=6.9 TH=1.8 O-RIN	3.000	PC	RC1018A0	ZINC PLATED D12 ELASTIC CLAMP	1.000	PC	RC1019A0	D=10 ELASTIC CLAMP	14.000	PC	RC1130A0	130x2,6 CLAM	2.000	PC	RC1242A0	D=10 CLOSED CAP	2.000	PC	TB2821A0	EPDM 6X10 L=40MM PIPE	6.000	PC	TB3004A0	TB2820A L=550mm EPDM BLACK PIPE	1.000	PC	TB3009B0	TB3132A-ONE OVEN WASHING INLET	1.000	PC	TB3225B0	TB2820A-TAN K-WASHYNG SYS CONNECTION	1.000	PC	VI1220A1	4,2x12 TCB SELF-TAPPIN G SCREW	1.000	PC	VL1019A0	VIBRATION DETERGENT PUMP	1.000	PC
Code	Description	Qty	UOM																																																							
0H2202A1	ONE WASHING WITH STEAM VALVE SUPPORT	1.000	PC																																																							
EL1440A0	WATER SELF CLEANING VALVE	1.000	PC																																																							
GN1526A0	INT. D.=6.9 TH=1.8 O-RIN	3.000	PC																																																							
RC1018A0	ZINC PLATED D12 ELASTIC CLAMP	1.000	PC																																																							
RC1019A0	D=10 ELASTIC CLAMP	14.000	PC																																																							
RC1130A0	130x2,6 CLAM	2.000	PC																																																							
RC1242A0	D=10 CLOSED CAP	2.000	PC																																																							
TB2821A0	EPDM 6X10 L=40MM PIPE	6.000	PC																																																							
TB3004A0	TB2820A L=550mm EPDM BLACK PIPE	1.000	PC																																																							
TB3009B0	TB3132A-ONE OVEN WASHING INLET	1.000	PC																																																							
TB3225B0	TB2820A-TAN K-WASHYNG SYS CONNECTION	1.000	PC																																																							
VI1220A1	4,2x12 TCB SELF-TAPPIN G SCREW	1.000	PC																																																							
VL1019A0	VIBRATION DETERGENT PUMP	1.000	PC																																																							



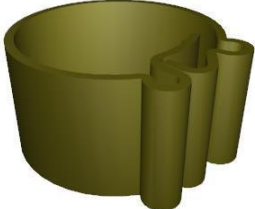

COMPONENT			SPARE PART																																										
Code	Description	Image	Code	Description	Kit components																																								
EL1440A	WATER SELF CLEANING VALVE		KVL1182A	ONE 1ROT CLEANING SYSTEM KIT (0311 EXC.)	<table border="1"> <thead> <tr> <th>Code</th> <th>Description</th> <th>Qty</th> <th>UOM</th> </tr> </thead> <tbody> <tr> <td>VL1047A1</td> <td>D6 PIPE HOLDER - D8 J.G. TERMINAL</td> <td>1.000</td> <td>PC</td> </tr> <tr> <td>VL1054B0</td> <td>ONE WASHING SYS INLET DISTRIBUTOR</td> <td>1.000</td> <td>PC</td> </tr> <tr> <td>VL1102A1</td> <td>DETERGENT LINE FILTER + BARBED VNR 6 MM</td> <td>1.000</td> <td>PC</td> </tr> <tr> <td>VL1128A1</td> <td>D6 BARBED CHECK VALVE</td> <td>2.000</td> <td>PC</td> </tr> <tr> <td>VL1166A0</td> <td>BB6-AR6 L FITTING</td> <td>1.000</td> <td>PC</td> </tr> <tr> <td>VL1174C0</td> <td>D1.2 MM CALIBRATED D1.2 MM</td> <td>1.000</td> <td>PC</td> </tr> <tr> <td>VL1191A0</td> <td>ONE WASHING DISTRIBUTOR OUTLETS KIT</td> <td>1.000</td> <td>PC</td> </tr> <tr> <td>VL1214A0</td> <td>BAYONET - 6mm BARBED NRV VALVE</td> <td>1.000</td> <td>PC</td> </tr> <tr> <td>VM2172A0</td> <td>LOCKING CLIP FOR PUMP WITH CIRCUIT</td> <td>2.000</td> <td>PC</td> </tr> </tbody> </table>	Code	Description	Qty	UOM	VL1047A1	D6 PIPE HOLDER - D8 J.G. TERMINAL	1.000	PC	VL1054B0	ONE WASHING SYS INLET DISTRIBUTOR	1.000	PC	VL1102A1	DETERGENT LINE FILTER + BARBED VNR 6 MM	1.000	PC	VL1128A1	D6 BARBED CHECK VALVE	2.000	PC	VL1166A0	BB6-AR6 L FITTING	1.000	PC	VL1174C0	D1.2 MM CALIBRATED D1.2 MM	1.000	PC	VL1191A0	ONE WASHING DISTRIBUTOR OUTLETS KIT	1.000	PC	VL1214A0	BAYONET - 6mm BARBED NRV VALVE	1.000	PC	VM2172A0	LOCKING CLIP FOR PUMP WITH CIRCUIT	2.000	PC
			Code	Description	Qty	UOM																																							
VL1047A1	D6 PIPE HOLDER - D8 J.G. TERMINAL	1.000	PC																																										
VL1054B0	ONE WASHING SYS INLET DISTRIBUTOR	1.000	PC																																										
VL1102A1	DETERGENT LINE FILTER + BARBED VNR 6 MM	1.000	PC																																										
VL1128A1	D6 BARBED CHECK VALVE	2.000	PC																																										
VL1166A0	BB6-AR6 L FITTING	1.000	PC																																										
VL1174C0	D1.2 MM CALIBRATED D1.2 MM	1.000	PC																																										
VL1191A0	ONE WASHING DISTRIBUTOR OUTLETS KIT	1.000	PC																																										
VL1214A0	BAYONET - 6mm BARBED NRV VALVE	1.000	PC																																										
VM2172A0	LOCKING CLIP FOR PUMP WITH CIRCUIT	2.000	PC																																										
KEL1440A	SELF CLEANING WATER VALVE KIT	<table border="1"> <thead> <tr> <th>Code</th> <th>Description</th> <th>Qty</th> <th>UOM</th> </tr> </thead> <tbody> <tr> <td>EL1440A0</td> <td>WATER SELF CLEANING VALVE</td> <td>1.000</td> <td>PC</td> </tr> <tr> <td>GN1526A0</td> <td>INT. D.=6.9 TH=1.8 O-RIN</td> <td>2.000</td> <td>PC</td> </tr> <tr> <td>RC1131A0</td> <td>200x2.6 BLACK CLAMP</td> <td>1.000</td> <td>PC</td> </tr> <tr> <td>VM2172A0</td> <td>LOCKING CLIP FOR PUMP WITH CIRCUIT</td> <td>1.000</td> <td>PC</td> </tr> </tbody> </table>	Code	Description	Qty	UOM	EL1440A0	WATER SELF CLEANING VALVE	1.000	PC	GN1526A0	INT. D.=6.9 TH=1.8 O-RIN	2.000	PC	RC1131A0	200x2.6 BLACK CLAMP	1.000	PC	VM2172A0	LOCKING CLIP FOR PUMP WITH CIRCUIT	1.000	PC																							
Code	Description	Qty	UOM																																										
EL1440A0	WATER SELF CLEANING VALVE	1.000	PC																																										
GN1526A0	INT. D.=6.9 TH=1.8 O-RIN	2.000	PC																																										
RC1131A0	200x2.6 BLACK CLAMP	1.000	PC																																										
VM2172A0	LOCKING CLIP FOR PUMP WITH CIRCUIT	1.000	PC																																										
GN1526A	INT. D.=6.9 TH=1.8 O-RING		KGN1526A	O-RING INT D6.9 THICK1.8 10PCS KIT	<table border="1"> <thead> <tr> <th>Code</th> <th>Description</th> <th>Qty</th> <th>UOM</th> </tr> </thead> <tbody> <tr> <td>GN1526A0</td> <td>INT. D.=6.9 TH=1.8 O-RIN</td> <td>10.000</td> <td>PC</td> </tr> </tbody> </table>	Code	Description	Qty	UOM	GN1526A0	INT. D.=6.9 TH=1.8 O-RIN	10.000	PC																																
Code	Description	Qty	UOM																																										
GN1526A0	INT. D.=6.9 TH=1.8 O-RIN	10.000	PC																																										



COMPONENT			SPARE PART										
Code	Description	Image	Code	Description	Kit components								
RC1019A	D=10 ELASTIC CLAM		KRC1019A	Ø10 ZINC PLATED ELASTIC CLAMP 15 PCS KIT	<table border="1"> <thead> <tr> <th>Code</th> <th>Description</th> <th>Qty</th> <th>UOM</th> </tr> </thead> <tbody> <tr> <td>RC1019A0</td> <td>D=10 ELASTIC CLAMP</td> <td>15.000</td> <td>PC</td> </tr> </tbody> </table>	Code	Description	Qty	UOM	RC1019A0	D=10 ELASTIC CLAMP	15.000	PC
Code	Description	Qty	UOM										
RC1019A0	D=10 ELASTIC CLAMP	15.000	PC										
RC1414A	D12 HOSE CLAMP		KRC1414A	D11-12 HOSE SNAP CLAMP 10 PCS KIT	<table border="1"> <thead> <tr> <th>Code</th> <th>Description</th> <th>Qty</th> <th>UOM</th> </tr> </thead> <tbody> <tr> <td>RC1414A0</td> <td>D12 HOSE CLAMP</td> <td>50.000</td> <td>PC</td> </tr> </tbody> </table>	Code	Description	Qty	UOM	RC1414A0	D12 HOSE CLAMP	50.000	PC
Code	Description	Qty	UOM										
RC1414A0	D12 HOSE CLAMP	50.000	PC										
TB3004A	TB2820A L=550mm EPDM BLACK PIPE		KTB1343A	TB2820A0 6x10 EPM DETERGENT PIPE 3M KIT	<table border="1"> <thead> <tr> <th>Code</th> <th>Description</th> <th>Qty</th> <th>UOM</th> </tr> </thead> <tbody> <tr> <td>TB2820A0</td> <td>6X10 EPDM PIPE FOR WASHING SYSTEM</td> <td>3.000</td> <td>M</td> </tr> </tbody> </table>	Code	Description	Qty	UOM	TB2820A0	6X10 EPDM PIPE FOR WASHING SYSTEM	3.000	M
Code	Description	Qty	UOM										
TB2820A0	6X10 EPDM PIPE FOR WASHING SYSTEM	3.000	M										
TB3005B	TB3132A L=550mm EPDM WHITE-BLUE PIPE		KTB3132A	WHITE-BLU 6X12 REINFORCED PIPE 3M KIT	<table border="1"> <thead> <tr> <th>Code</th> <th>Description</th> <th>Qty</th> <th>UOM</th> </tr> </thead> <tbody> <tr> <td>TB3132A0</td> <td>WHITE-BLUE EPDM TEXTILE BRAID HOSE 6x12</td> <td>3.000</td> <td>M</td> </tr> </tbody> </table>	Code	Description	Qty	UOM	TB3132A0	WHITE-BLUE EPDM TEXTILE BRAID HOSE 6x12	3.000	M
Code	Description	Qty	UOM										
TB3132A0	WHITE-BLUE EPDM TEXTILE BRAID HOSE 6x12	3.000	M										
TB3225B	TB2820A-TANK-WAS HYNG SYS CONNECTION		KTB1343A	TB2820A0 6x10 EPM DETERGENT PIPE 3M KIT	<table border="1"> <thead> <tr> <th>Code</th> <th>Description</th> <th>Qty</th> <th>UOM</th> </tr> </thead> <tbody> <tr> <td>TB2820A0</td> <td>6X10 EPDM PIPE FOR WASHING SYSTEM</td> <td>3.000</td> <td>M</td> </tr> </tbody> </table>	Code	Description	Qty	UOM	TB2820A0	6X10 EPDM PIPE FOR WASHING SYSTEM	3.000	M
Code	Description	Qty	UOM										
TB2820A0	6X10 EPDM PIPE FOR WASHING SYSTEM	3.000	M										



COMPONENT			SPARE PART																																																																		
Code	Description	Image	Code	Description	Kit components																																																																
VL1102A	DETERGENT LINE FILTER + BARBED VNR 6 MM		KVL1102A	DETERGENT FILTER + NRV KIT	<table border="1"> <thead> <tr> <th>Code</th> <th>Description</th> <th>Qty</th> <th>UOM</th> </tr> </thead> <tbody> <tr> <td>RC1019A0</td> <td>D=10 ELASTIC CLAMP</td> <td>5.000</td> <td>PC</td> </tr> <tr> <td>TB2820A0</td> <td>6X10 EPDM PIPE FOR WASHING SYSTEM</td> <td>0.040</td> <td>M</td> </tr> <tr> <td>VL1102A1</td> <td>DETERGENT LINE FILTER + BARBED VNR 6 MM</td> <td>1.000</td> <td>PC</td> </tr> </tbody> </table>	Code	Description	Qty	UOM	RC1019A0	D=10 ELASTIC CLAMP	5.000	PC	TB2820A0	6X10 EPDM PIPE FOR WASHING SYSTEM	0.040	M	VL1102A1	DETERGENT LINE FILTER + BARBED VNR 6 MM	1.000	PC																																																
Code	Description	Qty	UOM																																																																		
RC1019A0	D=10 ELASTIC CLAMP	5.000	PC																																																																		
TB2820A0	6X10 EPDM PIPE FOR WASHING SYSTEM	0.040	M																																																																		
VL1102A1	DETERGENT LINE FILTER + BARBED VNR 6 MM	1.000	PC																																																																		
VL1166A	BB6-AR6 L FITTING		KVL2618A	2 ROTOR ARMS ONE CLEANING SYSTEM KIT	<table border="1"> <thead> <tr> <th>Code</th> <th>Description</th> <th>Qty</th> <th>UOM</th> </tr> </thead> <tbody> <tr> <td>0H2202A1</td> <td>ONE WASHING WITH STEAM VALVE SUPPORT</td> <td>2.000</td> <td>PC</td> </tr> <tr> <td>CE1030A0</td> <td>FEMALE FASTON COVER 6.3X0.8 0,5-1mmq</td> <td>4.000</td> <td>PC</td> </tr> <tr> <td>CE1395A0</td> <td>6,3 X 0,8 MALE FASTO</td> <td>2.000</td> <td>PC</td> </tr> <tr> <td>CE1545A0</td> <td>BLUE UNIP AWG18 ST.3135 WIRE</td> <td>2.000</td> <td>M</td> </tr> <tr> <td>CE1570A0</td> <td>WHITE UNIP AWG18 ST.3135 WIRE</td> <td>2.000</td> <td>M</td> </tr> <tr> <td>CE1660A0</td> <td>6,3x0,8 FEMALE FASTON COVER</td> <td>4.000</td> <td>PC</td> </tr> <tr> <td>CE1661A0</td> <td>MALE FASTON COVER 6,3x0,8</td> <td>2.000</td> <td>PC</td> </tr> <tr> <td>EL1020A1</td> <td>D8 INTERMEDIAT E T-SHAPED FITTING</td> <td>1.000</td> <td>PC</td> </tr> <tr> <td>EL1440A0</td> <td>WATER SELF CLEANING VALVE</td> <td>2.000</td> <td>PC</td> </tr> <tr> <td>GN1526A0</td> <td>INT. D.=6.9 TH=1.8 O-RIN</td> <td>6.000</td> <td>PC</td> </tr> <tr> <td>RC1018A0</td> <td>ZINC PLATED D12 ELASTIC CLAMP</td> <td>2.000</td> <td>PC</td> </tr> <tr> <td>RC1019A0</td> <td>D=10 ELASTIC CLAMP</td> <td>28.000</td> <td>PC</td> </tr> <tr> <td>RC1130A0</td> <td>130x2,6 CLAM</td> <td>4.000</td> <td>PC</td> </tr> <tr> <td>RC1242A0</td> <td>D=10 CLOSED CAP</td> <td>4.000</td> <td>PC</td> </tr> <tr> <td>TB2821A0</td> <td>EPDM 6X10 L=40MM PIPE</td> <td>12.000</td> <td>PC</td> </tr> </tbody> </table>	Code	Description	Qty	UOM	0H2202A1	ONE WASHING WITH STEAM VALVE SUPPORT	2.000	PC	CE1030A0	FEMALE FASTON COVER 6.3X0.8 0,5-1mmq	4.000	PC	CE1395A0	6,3 X 0,8 MALE FASTO	2.000	PC	CE1545A0	BLUE UNIP AWG18 ST.3135 WIRE	2.000	M	CE1570A0	WHITE UNIP AWG18 ST.3135 WIRE	2.000	M	CE1660A0	6,3x0,8 FEMALE FASTON COVER	4.000	PC	CE1661A0	MALE FASTON COVER 6,3x0,8	2.000	PC	EL1020A1	D8 INTERMEDIAT E T-SHAPED FITTING	1.000	PC	EL1440A0	WATER SELF CLEANING VALVE	2.000	PC	GN1526A0	INT. D.=6.9 TH=1.8 O-RIN	6.000	PC	RC1018A0	ZINC PLATED D12 ELASTIC CLAMP	2.000	PC	RC1019A0	D=10 ELASTIC CLAMP	28.000	PC	RC1130A0	130x2,6 CLAM	4.000	PC	RC1242A0	D=10 CLOSED CAP	4.000	PC	TB2821A0	EPDM 6X10 L=40MM PIPE	12.000	PC
Code	Description	Qty	UOM																																																																		
0H2202A1	ONE WASHING WITH STEAM VALVE SUPPORT	2.000	PC																																																																		
CE1030A0	FEMALE FASTON COVER 6.3X0.8 0,5-1mmq	4.000	PC																																																																		
CE1395A0	6,3 X 0,8 MALE FASTO	2.000	PC																																																																		
CE1545A0	BLUE UNIP AWG18 ST.3135 WIRE	2.000	M																																																																		
CE1570A0	WHITE UNIP AWG18 ST.3135 WIRE	2.000	M																																																																		
CE1660A0	6,3x0,8 FEMALE FASTON COVER	4.000	PC																																																																		
CE1661A0	MALE FASTON COVER 6,3x0,8	2.000	PC																																																																		
EL1020A1	D8 INTERMEDIAT E T-SHAPED FITTING	1.000	PC																																																																		
EL1440A0	WATER SELF CLEANING VALVE	2.000	PC																																																																		
GN1526A0	INT. D.=6.9 TH=1.8 O-RIN	6.000	PC																																																																		
RC1018A0	ZINC PLATED D12 ELASTIC CLAMP	2.000	PC																																																																		
RC1019A0	D=10 ELASTIC CLAMP	28.000	PC																																																																		
RC1130A0	130x2,6 CLAM	4.000	PC																																																																		
RC1242A0	D=10 CLOSED CAP	4.000	PC																																																																		
TB2821A0	EPDM 6X10 L=40MM PIPE	12.000	PC																																																																		



COMPONENT			SPARE PART																																																																		
Code	Description	Image	Code	Description	Kit components																																																																
VL1166A	BB6-AR6 L FITTING		KVL2618A	2 ROTOR ARMS ONE CLEANING SYSTEM KIT	<table border="1"> <thead> <tr> <th>Code</th> <th>Description</th> <th>Qty</th> <th>UOM</th> </tr> </thead> <tbody> <tr> <td>TB3004A0</td> <td>TB2820A L=550mm EPDM BLACK PIPE</td> <td>2.000</td> <td>PC</td> </tr> <tr> <td>TB3009B0</td> <td>TB3132A-ONE OVEN WASHING INLET</td> <td>2.000</td> <td>PC</td> </tr> <tr> <td>TB3225B0</td> <td>TB2820A-TAN K-WASHYNG SYS CONNECTION</td> <td>2.000</td> <td>PC</td> </tr> <tr> <td>VI1220A1</td> <td>4,2x12 TCB SELF-TAPPIN G SCREW</td> <td>2.000</td> <td>PC</td> </tr> <tr> <td>VL1019A0</td> <td>VIBRATION DETERGENT PUMP</td> <td>2.000</td> <td>PC</td> </tr> <tr> <td>VL1047A1</td> <td>D6 PIPE HOLDER - D6 J.G. TERMINAL</td> <td>2.000</td> <td>PC</td> </tr> <tr> <td>VL1054B0</td> <td>ONE WASHING SYS INLET DISTRIBUTOR</td> <td>2.000</td> <td>PC</td> </tr> <tr> <td>VL1102A1</td> <td>DETERGENT LINE FILTER + BARBED VNR 6 MM</td> <td>2.000</td> <td>PC</td> </tr> <tr> <td>VL1127A1</td> <td>6mm BARBED T-SHAPED FITTING</td> <td>1.000</td> <td>PC</td> </tr> <tr> <td>VL1128A1</td> <td>D6 BARBED CHECK VALVE</td> <td>4.000</td> <td>PC</td> </tr> <tr> <td>VL1166A0</td> <td>BB6-AR6 L FITTING</td> <td>2.000</td> <td>PC</td> </tr> <tr> <td>VL1174C0</td> <td>D1.2 MM CALIBRATED D1.2 MM</td> <td>2.000</td> <td>PC</td> </tr> <tr> <td>VL1191A0</td> <td>ONE WASHING DISTRIBUTOR OUTLETS KIT</td> <td>2.000</td> <td>PC</td> </tr> <tr> <td>VL1214A0</td> <td>BAYONET - 6mm BARBED NRV VALVE</td> <td>2.000</td> <td>PC</td> </tr> <tr> <td>VM2172A0</td> <td>LOCKING CLIP FOR PUMP WITH CIRCUIT</td> <td>4.000</td> <td>PC</td> </tr> </tbody> </table>	Code	Description	Qty	UOM	TB3004A0	TB2820A L=550mm EPDM BLACK PIPE	2.000	PC	TB3009B0	TB3132A-ONE OVEN WASHING INLET	2.000	PC	TB3225B0	TB2820A-TAN K-WASHYNG SYS CONNECTION	2.000	PC	VI1220A1	4,2x12 TCB SELF-TAPPIN G SCREW	2.000	PC	VL1019A0	VIBRATION DETERGENT PUMP	2.000	PC	VL1047A1	D6 PIPE HOLDER - D6 J.G. TERMINAL	2.000	PC	VL1054B0	ONE WASHING SYS INLET DISTRIBUTOR	2.000	PC	VL1102A1	DETERGENT LINE FILTER + BARBED VNR 6 MM	2.000	PC	VL1127A1	6mm BARBED T-SHAPED FITTING	1.000	PC	VL1128A1	D6 BARBED CHECK VALVE	4.000	PC	VL1166A0	BB6-AR6 L FITTING	2.000	PC	VL1174C0	D1.2 MM CALIBRATED D1.2 MM	2.000	PC	VL1191A0	ONE WASHING DISTRIBUTOR OUTLETS KIT	2.000	PC	VL1214A0	BAYONET - 6mm BARBED NRV VALVE	2.000	PC	VM2172A0	LOCKING CLIP FOR PUMP WITH CIRCUIT	4.000	PC
Code	Description	Qty	UOM																																																																		
TB3004A0	TB2820A L=550mm EPDM BLACK PIPE	2.000	PC																																																																		
TB3009B0	TB3132A-ONE OVEN WASHING INLET	2.000	PC																																																																		
TB3225B0	TB2820A-TAN K-WASHYNG SYS CONNECTION	2.000	PC																																																																		
VI1220A1	4,2x12 TCB SELF-TAPPIN G SCREW	2.000	PC																																																																		
VL1019A0	VIBRATION DETERGENT PUMP	2.000	PC																																																																		
VL1047A1	D6 PIPE HOLDER - D6 J.G. TERMINAL	2.000	PC																																																																		
VL1054B0	ONE WASHING SYS INLET DISTRIBUTOR	2.000	PC																																																																		
VL1102A1	DETERGENT LINE FILTER + BARBED VNR 6 MM	2.000	PC																																																																		
VL1127A1	6mm BARBED T-SHAPED FITTING	1.000	PC																																																																		
VL1128A1	D6 BARBED CHECK VALVE	4.000	PC																																																																		
VL1166A0	BB6-AR6 L FITTING	2.000	PC																																																																		
VL1174C0	D1.2 MM CALIBRATED D1.2 MM	2.000	PC																																																																		
VL1191A0	ONE WASHING DISTRIBUTOR OUTLETS KIT	2.000	PC																																																																		
VL1214A0	BAYONET - 6mm BARBED NRV VALVE	2.000	PC																																																																		
VM2172A0	LOCKING CLIP FOR PUMP WITH CIRCUIT	4.000	PC																																																																		
			KVL1225A	US HOOD WASHING SYSTEM KIT	<table border="1"> <thead> <tr> <th>Code</th> <th>Description</th> <th>Qty</th> <th>UOM</th> </tr> </thead> <tbody> <tr> <td>0H2213A1</td> <td>HOOD WATER CIRCUIT PLAT</td> <td>1.000</td> <td>PC</td> </tr> </tbody> </table>	Code	Description	Qty	UOM	0H2213A1	HOOD WATER CIRCUIT PLAT	1.000	PC																																																								
Code	Description	Qty	UOM																																																																		
0H2213A1	HOOD WATER CIRCUIT PLAT	1.000	PC																																																																		



COMPONENT			SPARE PART																																																																																						
Code	Description	Image	Code	Description	Kit components																																																																																				
VL1166A	BB6-AR6 L FITTING		KVL1225A	US HOOD WASHING SYSTEM KIT	<table border="1"> <thead> <tr> <th>Code</th> <th>Description</th> <th>Qty</th> <th>UOM</th> </tr> </thead> <tbody> <tr> <td>EL1450A0</td> <td>US SELF-CLEANING G WATER SOLENOID</td> <td>2.000</td> <td>PC</td> </tr> <tr> <td>GN1526A0</td> <td>INT. D.=6.9 TH=1.8 O-RING</td> <td>5.000</td> <td>PC</td> </tr> <tr> <td>RC1018A0</td> <td>ZINC PLATED D12 ELASTIC CLAMP</td> <td>4.000</td> <td>PC</td> </tr> <tr> <td>RC1019A0</td> <td>D=10 ELASTIC CLAMP</td> <td>16.000</td> <td>PC</td> </tr> <tr> <td>RC1131A0</td> <td>200x2.6 BLACK CLAMP</td> <td>1.000</td> <td>PC</td> </tr> <tr> <td>RC1242A0</td> <td>D=10 CLOSED CAP</td> <td>2.000</td> <td>PC</td> </tr> <tr> <td>TB2821A0</td> <td>EPDM 6X10 L=40MM PIPE</td> <td>6.000</td> <td>PC</td> </tr> <tr> <td>TB2994A0</td> <td>HOOD DETERGENT PIPE</td> <td>2.000</td> <td>PC</td> </tr> <tr> <td>TB3252A0</td> <td>TB3252A0</td> <td>2.000</td> <td>PC</td> </tr> <tr> <td>VI1220A1</td> <td>4,2x12 TCB SELF-TAPPING G SCREW</td> <td>3.000</td> <td>PC</td> </tr> <tr> <td>VL1019A0</td> <td>VIBRATION DETERGENT PUMP</td> <td>1.000</td> <td>PC</td> </tr> <tr> <td>VL1047A1</td> <td>D6 PIPE HOLDER - D8 J.G. TERMINAL</td> <td>1.000</td> <td>PC</td> </tr> <tr> <td>VL1054B0</td> <td>ONE WASHING SYS INLET DISTRIBUTOR</td> <td>1.000</td> <td>PC</td> </tr> <tr> <td>VL1102A1</td> <td>DETERGENT LINE FILTER + BARBED VNR 6 MM</td> <td>1.000</td> <td>PC</td> </tr> <tr> <td>VL1127A1</td> <td>6mm BARBED T-SHAPED FITTING</td> <td>1.000</td> <td>PC</td> </tr> <tr> <td>VL1128A1</td> <td>D6 BARBED CHECK VALVE</td> <td>2.000</td> <td>PC</td> </tr> <tr> <td>VL1165A0</td> <td>BAM-BB6 STRAIGHT FITTING</td> <td>1.000</td> <td>PC</td> </tr> <tr> <td>VL1166A0</td> <td>BB6-AR6 L FITTING</td> <td>2.000</td> <td>PC</td> </tr> <tr> <td>VL1174C0</td> <td>D1.2 MM CALIBRATED D1.2 MM</td> <td>1.000</td> <td>PC</td> </tr> <tr> <td>VL1191A0</td> <td>ONE WASHING DISTRIBUTOR OUTLETS KIT</td> <td>1.000</td> <td>PC</td> </tr> </tbody> </table>	Code	Description	Qty	UOM	EL1450A0	US SELF-CLEANING G WATER SOLENOID	2.000	PC	GN1526A0	INT. D.=6.9 TH=1.8 O-RING	5.000	PC	RC1018A0	ZINC PLATED D12 ELASTIC CLAMP	4.000	PC	RC1019A0	D=10 ELASTIC CLAMP	16.000	PC	RC1131A0	200x2.6 BLACK CLAMP	1.000	PC	RC1242A0	D=10 CLOSED CAP	2.000	PC	TB2821A0	EPDM 6X10 L=40MM PIPE	6.000	PC	TB2994A0	HOOD DETERGENT PIPE	2.000	PC	TB3252A0	TB3252A0	2.000	PC	VI1220A1	4,2x12 TCB SELF-TAPPING G SCREW	3.000	PC	VL1019A0	VIBRATION DETERGENT PUMP	1.000	PC	VL1047A1	D6 PIPE HOLDER - D8 J.G. TERMINAL	1.000	PC	VL1054B0	ONE WASHING SYS INLET DISTRIBUTOR	1.000	PC	VL1102A1	DETERGENT LINE FILTER + BARBED VNR 6 MM	1.000	PC	VL1127A1	6mm BARBED T-SHAPED FITTING	1.000	PC	VL1128A1	D6 BARBED CHECK VALVE	2.000	PC	VL1165A0	BAM-BB6 STRAIGHT FITTING	1.000	PC	VL1166A0	BB6-AR6 L FITTING	2.000	PC	VL1174C0	D1.2 MM CALIBRATED D1.2 MM	1.000	PC	VL1191A0	ONE WASHING DISTRIBUTOR OUTLETS KIT	1.000	PC
Code	Description	Qty	UOM																																																																																						
EL1450A0	US SELF-CLEANING G WATER SOLENOID	2.000	PC																																																																																						
GN1526A0	INT. D.=6.9 TH=1.8 O-RING	5.000	PC																																																																																						
RC1018A0	ZINC PLATED D12 ELASTIC CLAMP	4.000	PC																																																																																						
RC1019A0	D=10 ELASTIC CLAMP	16.000	PC																																																																																						
RC1131A0	200x2.6 BLACK CLAMP	1.000	PC																																																																																						
RC1242A0	D=10 CLOSED CAP	2.000	PC																																																																																						
TB2821A0	EPDM 6X10 L=40MM PIPE	6.000	PC																																																																																						
TB2994A0	HOOD DETERGENT PIPE	2.000	PC																																																																																						
TB3252A0	TB3252A0	2.000	PC																																																																																						
VI1220A1	4,2x12 TCB SELF-TAPPING G SCREW	3.000	PC																																																																																						
VL1019A0	VIBRATION DETERGENT PUMP	1.000	PC																																																																																						
VL1047A1	D6 PIPE HOLDER - D8 J.G. TERMINAL	1.000	PC																																																																																						
VL1054B0	ONE WASHING SYS INLET DISTRIBUTOR	1.000	PC																																																																																						
VL1102A1	DETERGENT LINE FILTER + BARBED VNR 6 MM	1.000	PC																																																																																						
VL1127A1	6mm BARBED T-SHAPED FITTING	1.000	PC																																																																																						
VL1128A1	D6 BARBED CHECK VALVE	2.000	PC																																																																																						
VL1165A0	BAM-BB6 STRAIGHT FITTING	1.000	PC																																																																																						
VL1166A0	BB6-AR6 L FITTING	2.000	PC																																																																																						
VL1174C0	D1.2 MM CALIBRATED D1.2 MM	1.000	PC																																																																																						
VL1191A0	ONE WASHING DISTRIBUTOR OUTLETS KIT	1.000	PC																																																																																						





COMPONENT			SPARE PART																																																											
Code	Description	Image	Code	Description	Kit components																																																									
VL1166A	BB6-AR6 L FITTING		KVL1225A	US HOOD WASHING SYSTEM KIT	<table border="1"> <thead> <tr> <th>Code</th> <th>Description</th> <th>Qty</th> <th>UOM</th> </tr> </thead> <tbody> <tr> <td>VL1214A0</td> <td>BAYONET - 6mm BARBED NRV VALVE</td> <td>1.000</td> <td>PC</td> </tr> <tr> <td>VM1605A0</td> <td>CLIP TWIST LOCK DIAM. 10,2-12,7 MM</td> <td>2.000</td> <td>PC</td> </tr> <tr> <td>VM2172A0</td> <td>LOCKING CLIP FOR PUMP WITH CIRCUIT</td> <td>3.000</td> <td>PC</td> </tr> </tbody> </table>	Code	Description	Qty	UOM	VL1214A0	BAYONET - 6mm BARBED NRV VALVE	1.000	PC	VM1605A0	CLIP TWIST LOCK DIAM. 10,2-12,7 MM	2.000	PC	VM2172A0	LOCKING CLIP FOR PUMP WITH CIRCUIT	3.000	PC																																									
			Code	Description	Qty	UOM																																																								
VL1214A0	BAYONET - 6mm BARBED NRV VALVE	1.000	PC																																																											
VM1605A0	CLIP TWIST LOCK DIAM. 10,2-12,7 MM	2.000	PC																																																											
VM2172A0	LOCKING CLIP FOR PUMP WITH CIRCUIT	3.000	PC																																																											
KVL1222A	EUR 0311 ONE PLUS CLEANING SYSTEM KIT	<table border="1"> <thead> <tr> <th>Code</th> <th>Description</th> <th>Qty</th> <th>UOM</th> </tr> </thead> <tbody> <tr> <td>0H2486A0</td> <td>0311 WASHING CIRCUIT PLAT</td> <td>1.000</td> <td>PC</td> </tr> <tr> <td>EL1440A0</td> <td>WATER SELF CLEANING VALVE</td> <td>1.000</td> <td>PC</td> </tr> <tr> <td>GN1526A0</td> <td>INT. D.=6.9 TH=1.8 O-RIN</td> <td>3.000</td> <td>PC</td> </tr> <tr> <td>RC1018A0</td> <td>ZINC PLATED D12 ELASTIC CLAMP</td> <td>1.000</td> <td>PC</td> </tr> <tr> <td>RC1019A0</td> <td>D=10 ELASTIC CLAMP</td> <td>14.000</td> <td>PC</td> </tr> <tr> <td>RC1242A0</td> <td>D=10 CLOSED CAP</td> <td>2.000</td> <td>PC</td> </tr> <tr> <td>TB2821A0</td> <td>EPDM 6X10 L=40MM PIPE</td> <td>6.000</td> <td>PC</td> </tr> <tr> <td>TB3004A0</td> <td>TB2820A L=550mm EPDM BLACK PIPE</td> <td>1.000</td> <td>PC</td> </tr> <tr> <td>TB3009B0</td> <td>TB3132A-ONE OVEN WASHING INLET</td> <td>1.000</td> <td>PC</td> </tr> <tr> <td>TB3225B0</td> <td>TB2820A-TAN K-WASHYNG SYS CONNECTION</td> <td>1.000</td> <td>PC</td> </tr> <tr> <td>V11220A1</td> <td>4,2x12 TCB SELF-TAPPIN G SCREW</td> <td>4.000</td> <td>PC</td> </tr> <tr> <td>VL1019A0</td> <td>VIBRATION DETERGENT PUMP</td> <td>1.000</td> <td>PC</td> </tr> <tr> <td>VL1047A1</td> <td>D6 PIPE HOLDER - D8 J.G. TERMINAL</td> <td>1.000</td> <td>PC</td> </tr> <tr> <td>VL1054B0</td> <td>ONE WASHING SYS INLET DISTRIBUTOR</td> <td>1.000</td> <td>PC</td> </tr> </tbody> </table>	Code	Description	Qty	UOM	0H2486A0	0311 WASHING CIRCUIT PLAT	1.000	PC	EL1440A0	WATER SELF CLEANING VALVE	1.000	PC	GN1526A0	INT. D.=6.9 TH=1.8 O-RIN	3.000	PC	RC1018A0	ZINC PLATED D12 ELASTIC CLAMP	1.000	PC	RC1019A0	D=10 ELASTIC CLAMP	14.000	PC	RC1242A0	D=10 CLOSED CAP	2.000	PC	TB2821A0	EPDM 6X10 L=40MM PIPE	6.000	PC	TB3004A0	TB2820A L=550mm EPDM BLACK PIPE	1.000	PC	TB3009B0	TB3132A-ONE OVEN WASHING INLET	1.000	PC	TB3225B0	TB2820A-TAN K-WASHYNG SYS CONNECTION	1.000	PC	V11220A1	4,2x12 TCB SELF-TAPPIN G SCREW	4.000	PC	VL1019A0	VIBRATION DETERGENT PUMP	1.000	PC	VL1047A1	D6 PIPE HOLDER - D8 J.G. TERMINAL	1.000	PC	VL1054B0	ONE WASHING SYS INLET DISTRIBUTOR	1.000	PC
Code	Description	Qty	UOM																																																											
0H2486A0	0311 WASHING CIRCUIT PLAT	1.000	PC																																																											
EL1440A0	WATER SELF CLEANING VALVE	1.000	PC																																																											
GN1526A0	INT. D.=6.9 TH=1.8 O-RIN	3.000	PC																																																											
RC1018A0	ZINC PLATED D12 ELASTIC CLAMP	1.000	PC																																																											
RC1019A0	D=10 ELASTIC CLAMP	14.000	PC																																																											
RC1242A0	D=10 CLOSED CAP	2.000	PC																																																											
TB2821A0	EPDM 6X10 L=40MM PIPE	6.000	PC																																																											
TB3004A0	TB2820A L=550mm EPDM BLACK PIPE	1.000	PC																																																											
TB3009B0	TB3132A-ONE OVEN WASHING INLET	1.000	PC																																																											
TB3225B0	TB2820A-TAN K-WASHYNG SYS CONNECTION	1.000	PC																																																											
V11220A1	4,2x12 TCB SELF-TAPPIN G SCREW	4.000	PC																																																											
VL1019A0	VIBRATION DETERGENT PUMP	1.000	PC																																																											
VL1047A1	D6 PIPE HOLDER - D8 J.G. TERMINAL	1.000	PC																																																											
VL1054B0	ONE WASHING SYS INLET DISTRIBUTOR	1.000	PC																																																											



COMPONENT			SPARE PART																																																						
Code	Description	Image	Code	Description	Kit components																																																				
VL1166A	BB6-AR6 L FITTING		KVL1222A	EUR 0311 ONE PLUS CLEANING SYSTEM KIT	<table border="1"> <thead> <tr> <th>Code</th> <th>Description</th> <th>Qty</th> <th>UOM</th> </tr> </thead> <tbody> <tr> <td>VL1102A1</td> <td>DETERGENT LINE FILTER + BARBED VNR 6 MM</td> <td>1.000</td> <td>PC</td> </tr> <tr> <td>VL1128A1</td> <td>D6 BARBED CHECK VALVE</td> <td>2.000</td> <td>PC</td> </tr> <tr> <td>VL1166A0</td> <td>BB6-AR6 L FITTING</td> <td>1.000</td> <td>PC</td> </tr> <tr> <td>VL1174C0</td> <td>D1.2 MM CALIBRATED D1.2 MM</td> <td>1.000</td> <td>PC</td> </tr> <tr> <td>VL1191A0</td> <td>ONE WASHING DISTRIBUTOR OUTLETS KIT</td> <td>1.000</td> <td>PC</td> </tr> <tr> <td>VL1214A0</td> <td>BAYONET - 6mm BARBED NRV VALVE</td> <td>1.000</td> <td>PC</td> </tr> <tr> <td>VM2172A0</td> <td>LOCKING CLIP FOR PUMP WITH CIRCUIT</td> <td>2.000</td> <td>PC</td> </tr> </tbody> </table>	Code	Description	Qty	UOM	VL1102A1	DETERGENT LINE FILTER + BARBED VNR 6 MM	1.000	PC	VL1128A1	D6 BARBED CHECK VALVE	2.000	PC	VL1166A0	BB6-AR6 L FITTING	1.000	PC	VL1174C0	D1.2 MM CALIBRATED D1.2 MM	1.000	PC	VL1191A0	ONE WASHING DISTRIBUTOR OUTLETS KIT	1.000	PC	VL1214A0	BAYONET - 6mm BARBED NRV VALVE	1.000	PC	VM2172A0	LOCKING CLIP FOR PUMP WITH CIRCUIT	2.000	PC																				
Code	Description	Qty	UOM																																																						
VL1102A1	DETERGENT LINE FILTER + BARBED VNR 6 MM	1.000	PC																																																						
VL1128A1	D6 BARBED CHECK VALVE	2.000	PC																																																						
VL1166A0	BB6-AR6 L FITTING	1.000	PC																																																						
VL1174C0	D1.2 MM CALIBRATED D1.2 MM	1.000	PC																																																						
VL1191A0	ONE WASHING DISTRIBUTOR OUTLETS KIT	1.000	PC																																																						
VL1214A0	BAYONET - 6mm BARBED NRV VALVE	1.000	PC																																																						
VM2172A0	LOCKING CLIP FOR PUMP WITH CIRCUIT	2.000	PC																																																						
			KVL1213A	US PLUS COMPACT WASHING SYSTEM KIT	<table border="1"> <thead> <tr> <th>Code</th> <th>Description</th> <th>Qty</th> <th>UOM</th> </tr> </thead> <tbody> <tr> <td>0H2428A2</td> <td>XECC PLUS WASHING CIRCUIT PLAT</td> <td>1.000</td> <td>PC</td> </tr> <tr> <td>EL1450A0</td> <td>US SELF-CLEANING WATER SOLENOID</td> <td>3.000</td> <td>PC</td> </tr> <tr> <td>GN1312A0</td> <td>RUBBER CABLE-PASSING NG DE=26 DI=15 SP=10</td> <td>1.000</td> <td>PC</td> </tr> <tr> <td>GN1526A0</td> <td>INT. D.=6.9 TH=1.8 O-RING</td> <td>7.000</td> <td>PC</td> </tr> <tr> <td>RC1018A0</td> <td>ZINC PLATED D12 ELASTIC CLAMP</td> <td>2.000</td> <td>PC</td> </tr> <tr> <td>RC1019A0</td> <td>D=10 ELASTIC CLAMP</td> <td>14.000</td> <td>PC</td> </tr> <tr> <td>RC1130A0</td> <td>130x2.6 CLAMP</td> <td>1.000</td> <td>PC</td> </tr> <tr> <td>RC1131A0</td> <td>200x2.6 BLACK CLAMP</td> <td>1.000</td> <td>PC</td> </tr> <tr> <td>RC1242A0</td> <td>D=10 CLOSED CAP</td> <td>2.000</td> <td>PC</td> </tr> <tr> <td>RC1356A0</td> <td>"STRAIGHT THREADED FEMALE END 8x1/4" BS</td> <td>1.000</td> <td>PC</td> </tr> <tr> <td>TB2821A0</td> <td>EPDM 6X10 L=40MM PIPE</td> <td>6.000</td> <td>PC</td> </tr> <tr> <td>TB3004A0</td> <td>TB2820A L=550mm EPDM BLACK PIPE</td> <td>1.000</td> <td>PC</td> </tr> </tbody> </table>	Code	Description	Qty	UOM	0H2428A2	XECC PLUS WASHING CIRCUIT PLAT	1.000	PC	EL1450A0	US SELF-CLEANING WATER SOLENOID	3.000	PC	GN1312A0	RUBBER CABLE-PASSING NG DE=26 DI=15 SP=10	1.000	PC	GN1526A0	INT. D.=6.9 TH=1.8 O-RING	7.000	PC	RC1018A0	ZINC PLATED D12 ELASTIC CLAMP	2.000	PC	RC1019A0	D=10 ELASTIC CLAMP	14.000	PC	RC1130A0	130x2.6 CLAMP	1.000	PC	RC1131A0	200x2.6 BLACK CLAMP	1.000	PC	RC1242A0	D=10 CLOSED CAP	2.000	PC	RC1356A0	"STRAIGHT THREADED FEMALE END 8x1/4" BS	1.000	PC	TB2821A0	EPDM 6X10 L=40MM PIPE	6.000	PC	TB3004A0	TB2820A L=550mm EPDM BLACK PIPE	1.000	PC
Code	Description	Qty	UOM																																																						
0H2428A2	XECC PLUS WASHING CIRCUIT PLAT	1.000	PC																																																						
EL1450A0	US SELF-CLEANING WATER SOLENOID	3.000	PC																																																						
GN1312A0	RUBBER CABLE-PASSING NG DE=26 DI=15 SP=10	1.000	PC																																																						
GN1526A0	INT. D.=6.9 TH=1.8 O-RING	7.000	PC																																																						
RC1018A0	ZINC PLATED D12 ELASTIC CLAMP	2.000	PC																																																						
RC1019A0	D=10 ELASTIC CLAMP	14.000	PC																																																						
RC1130A0	130x2.6 CLAMP	1.000	PC																																																						
RC1131A0	200x2.6 BLACK CLAMP	1.000	PC																																																						
RC1242A0	D=10 CLOSED CAP	2.000	PC																																																						
RC1356A0	"STRAIGHT THREADED FEMALE END 8x1/4" BS	1.000	PC																																																						
TB2821A0	EPDM 6X10 L=40MM PIPE	6.000	PC																																																						
TB3004A0	TB2820A L=550mm EPDM BLACK PIPE	1.000	PC																																																						



COMPONENT			SPARE PART																																																										
Code	Description	Image	Code	Description	Kit components																																																								
VL1166A	BB6-AR6 L FITTING		KVL1213A	US PLUS COMPACT WASHING SYSTEM KIT	<table border="1"> <thead> <tr> <th>Code</th> <th>Description</th> <th>Qty</th> <th>UOM</th> </tr> </thead> <tbody> <tr> <td>TB3005B0</td> <td>TB3132A L=550mm EPDM WHITE-BLUE PIPE</td> <td>1.000</td> <td>PC</td> </tr> <tr> <td>TB3469A0</td> <td></td> <td>1.000</td> <td>PC</td> </tr> <tr> <td>VL1019A0</td> <td>VIBRATION DETERGENT PUMP</td> <td>1.000</td> <td>PC</td> </tr> <tr> <td>VL1047A1</td> <td>D6 PIPE HOLDER - D8 J.G. TERMINAL</td> <td>1.000</td> <td>PC</td> </tr> <tr> <td>VL1054B0</td> <td>ONE WASHING SYS INLET DISTRIBUTOR</td> <td>1.000</td> <td>PC</td> </tr> <tr> <td>VL1065A1</td> <td>1/4 MALE N.O. PRESSURE SWITCH</td> <td>1.000</td> <td>PC</td> </tr> <tr> <td>VL1102A1</td> <td>DETERGENT LINE FILTER + BARBED VNR 6 MM</td> <td>1.000</td> <td>PC</td> </tr> <tr> <td>VL1128A1</td> <td>D6 BARBED CHECK VALVE</td> <td>2.000</td> <td>PC</td> </tr> <tr> <td>VL1165A0</td> <td>BAM-BB6 STRAIGHT FITTING</td> <td>1.000</td> <td>PC</td> </tr> <tr> <td>VL1166A0</td> <td>BB6-AR6 L FITTING</td> <td>3.000</td> <td>PC</td> </tr> <tr> <td>VL1174C0</td> <td>D1.2 MM CALIBRATED D1.2 MM</td> <td>1.000</td> <td>PC</td> </tr> <tr> <td>VL1185A0</td> <td>2 WAYS PLUS WASHING DISTRIBUTOR</td> <td>1.000</td> <td>PC</td> </tr> <tr> <td>VM2172A0</td> <td>LOCKING CLIP FOR PUMP WITH CIRCUIT</td> <td>6.000</td> <td>PC</td> </tr> </tbody> </table>	Code	Description	Qty	UOM	TB3005B0	TB3132A L=550mm EPDM WHITE-BLUE PIPE	1.000	PC	TB3469A0		1.000	PC	VL1019A0	VIBRATION DETERGENT PUMP	1.000	PC	VL1047A1	D6 PIPE HOLDER - D8 J.G. TERMINAL	1.000	PC	VL1054B0	ONE WASHING SYS INLET DISTRIBUTOR	1.000	PC	VL1065A1	1/4 MALE N.O. PRESSURE SWITCH	1.000	PC	VL1102A1	DETERGENT LINE FILTER + BARBED VNR 6 MM	1.000	PC	VL1128A1	D6 BARBED CHECK VALVE	2.000	PC	VL1165A0	BAM-BB6 STRAIGHT FITTING	1.000	PC	VL1166A0	BB6-AR6 L FITTING	3.000	PC	VL1174C0	D1.2 MM CALIBRATED D1.2 MM	1.000	PC	VL1185A0	2 WAYS PLUS WASHING DISTRIBUTOR	1.000	PC	VM2172A0	LOCKING CLIP FOR PUMP WITH CIRCUIT	6.000	PC
Code	Description	Qty	UOM																																																										
TB3005B0	TB3132A L=550mm EPDM WHITE-BLUE PIPE	1.000	PC																																																										
TB3469A0		1.000	PC																																																										
VL1019A0	VIBRATION DETERGENT PUMP	1.000	PC																																																										
VL1047A1	D6 PIPE HOLDER - D8 J.G. TERMINAL	1.000	PC																																																										
VL1054B0	ONE WASHING SYS INLET DISTRIBUTOR	1.000	PC																																																										
VL1065A1	1/4 MALE N.O. PRESSURE SWITCH	1.000	PC																																																										
VL1102A1	DETERGENT LINE FILTER + BARBED VNR 6 MM	1.000	PC																																																										
VL1128A1	D6 BARBED CHECK VALVE	2.000	PC																																																										
VL1165A0	BAM-BB6 STRAIGHT FITTING	1.000	PC																																																										
VL1166A0	BB6-AR6 L FITTING	3.000	PC																																																										
VL1174C0	D1.2 MM CALIBRATED D1.2 MM	1.000	PC																																																										
VL1185A0	2 WAYS PLUS WASHING DISTRIBUTOR	1.000	PC																																																										
VM2172A0	LOCKING CLIP FOR PUMP WITH CIRCUIT	6.000	PC																																																										
			KVL1212A	EUR COMPACT PLUS CLEANING SYSTEM KIT	<table border="1"> <thead> <tr> <th>Code</th> <th>Description</th> <th>Qty</th> <th>UOM</th> </tr> </thead> <tbody> <tr> <td>0H2428A2</td> <td>XECC PLUS WASHING CIRCUIT PLAT</td> <td>1.000</td> <td>PC</td> </tr> <tr> <td>EL1440A0</td> <td>WATER SELF CLEANING VALVE</td> <td>3.000</td> <td>PC</td> </tr> <tr> <td>GN1312A0</td> <td>RUBBER CABLE-PASSI NG DE=26 DI=15 SP=10</td> <td>1.000</td> <td>PC</td> </tr> <tr> <td>GN1526A0</td> <td>INT. D.=6.9 TH=1.8 O-RIN</td> <td>7.000</td> <td>PC</td> </tr> </tbody> </table>	Code	Description	Qty	UOM	0H2428A2	XECC PLUS WASHING CIRCUIT PLAT	1.000	PC	EL1440A0	WATER SELF CLEANING VALVE	3.000	PC	GN1312A0	RUBBER CABLE-PASSI NG DE=26 DI=15 SP=10	1.000	PC	GN1526A0	INT. D.=6.9 TH=1.8 O-RIN	7.000	PC																																				
Code	Description	Qty	UOM																																																										
0H2428A2	XECC PLUS WASHING CIRCUIT PLAT	1.000	PC																																																										
EL1440A0	WATER SELF CLEANING VALVE	3.000	PC																																																										
GN1312A0	RUBBER CABLE-PASSI NG DE=26 DI=15 SP=10	1.000	PC																																																										
GN1526A0	INT. D.=6.9 TH=1.8 O-RIN	7.000	PC																																																										

COMPONENT			SPARE PART																																																																																		
Code	Description	Image	Code	Description	Kit components																																																																																
VL1166A	BB6-AR6 L FITTING		KVL1212A	EUR COMPACT PLUS CLEANING SYSTEM KIT	<table border="1"> <thead> <tr> <th>Code</th> <th>Description</th> <th>Qty</th> <th>UOM</th> </tr> </thead> <tbody> <tr> <td>RC1018A0</td> <td>ZINC PLATED D12 ELASTIC CLAMP</td> <td>2.000</td> <td>PC</td> </tr> <tr> <td>RC1019A0</td> <td>D=10 ELASTIC CLAMP</td> <td>14.000</td> <td>PC</td> </tr> <tr> <td>RC1130A0</td> <td>130x2,6 CLAM</td> <td>1.000</td> <td>PC</td> </tr> <tr> <td>RC1131A0</td> <td>200x2,6 BLACK CLAMP</td> <td>1.000</td> <td>PC</td> </tr> <tr> <td>RC1242A0</td> <td>D=10 CLOSED CAP</td> <td>2.000</td> <td>PC</td> </tr> <tr> <td>RC1356A0</td> <td>"STRAIGHT THREADED FEMALE END 8x1/4" BS</td> <td>1.000</td> <td>PC</td> </tr> <tr> <td>TB2821A0</td> <td>EPDM 6X10 L=40MM PIPE</td> <td>6.000</td> <td>PC</td> </tr> <tr> <td>TB3004A0</td> <td>TB2820A L=550mm EPDM BLACK PIPE</td> <td>2.000</td> <td>PC</td> </tr> <tr> <td>TB3005B0</td> <td>TB3132A L=550mm EPDM WHITE-BLUE PIPE</td> <td>1.000</td> <td>PC</td> </tr> <tr> <td>TB3469A0</td> <td></td> <td>1.000</td> <td>PC</td> </tr> <tr> <td>VL1019A0</td> <td>VIBRATION DETERGENT PUMP</td> <td>1.000</td> <td>PC</td> </tr> <tr> <td>VL1047A1</td> <td>D6 PIPE HOLDER - D6 J.G. TERMINAL</td> <td>1.000</td> <td>PC</td> </tr> <tr> <td>VL1054B0</td> <td>ONE WASHING SYS INLET DISTRIBUTOR</td> <td>1.000</td> <td>PC</td> </tr> <tr> <td>VL1065A1</td> <td>1/4 MALE N.O. PRESSURE SWITCH</td> <td>1.000</td> <td>PC</td> </tr> <tr> <td>VL1102A1</td> <td>DETERGENT LINE FILTER + BARBED VNR 6 MM</td> <td>1.000</td> <td>PC</td> </tr> <tr> <td>VL1128A1</td> <td>D6 BARBED CHECK VALVE</td> <td>2.000</td> <td>PC</td> </tr> <tr> <td>VL1165A0</td> <td>BAM-BB6 STRAIGHT FITTING</td> <td>1.000</td> <td>PC</td> </tr> <tr> <td>VL1166A0</td> <td>BB6-AR6 L FITTING</td> <td>3.000</td> <td>PC</td> </tr> <tr> <td>VL1174C0</td> <td>D1.2 MM CALIBRATED D1.2 MM</td> <td>1.000</td> <td>PC</td> </tr> </tbody> </table>	Code	Description	Qty	UOM	RC1018A0	ZINC PLATED D12 ELASTIC CLAMP	2.000	PC	RC1019A0	D=10 ELASTIC CLAMP	14.000	PC	RC1130A0	130x2,6 CLAM	1.000	PC	RC1131A0	200x2,6 BLACK CLAMP	1.000	PC	RC1242A0	D=10 CLOSED CAP	2.000	PC	RC1356A0	"STRAIGHT THREADED FEMALE END 8x1/4" BS	1.000	PC	TB2821A0	EPDM 6X10 L=40MM PIPE	6.000	PC	TB3004A0	TB2820A L=550mm EPDM BLACK PIPE	2.000	PC	TB3005B0	TB3132A L=550mm EPDM WHITE-BLUE PIPE	1.000	PC	TB3469A0		1.000	PC	VL1019A0	VIBRATION DETERGENT PUMP	1.000	PC	VL1047A1	D6 PIPE HOLDER - D6 J.G. TERMINAL	1.000	PC	VL1054B0	ONE WASHING SYS INLET DISTRIBUTOR	1.000	PC	VL1065A1	1/4 MALE N.O. PRESSURE SWITCH	1.000	PC	VL1102A1	DETERGENT LINE FILTER + BARBED VNR 6 MM	1.000	PC	VL1128A1	D6 BARBED CHECK VALVE	2.000	PC	VL1165A0	BAM-BB6 STRAIGHT FITTING	1.000	PC	VL1166A0	BB6-AR6 L FITTING	3.000	PC	VL1174C0	D1.2 MM CALIBRATED D1.2 MM	1.000	PC
Code	Description	Qty	UOM																																																																																		
RC1018A0	ZINC PLATED D12 ELASTIC CLAMP	2.000	PC																																																																																		
RC1019A0	D=10 ELASTIC CLAMP	14.000	PC																																																																																		
RC1130A0	130x2,6 CLAM	1.000	PC																																																																																		
RC1131A0	200x2,6 BLACK CLAMP	1.000	PC																																																																																		
RC1242A0	D=10 CLOSED CAP	2.000	PC																																																																																		
RC1356A0	"STRAIGHT THREADED FEMALE END 8x1/4" BS	1.000	PC																																																																																		
TB2821A0	EPDM 6X10 L=40MM PIPE	6.000	PC																																																																																		
TB3004A0	TB2820A L=550mm EPDM BLACK PIPE	2.000	PC																																																																																		
TB3005B0	TB3132A L=550mm EPDM WHITE-BLUE PIPE	1.000	PC																																																																																		
TB3469A0		1.000	PC																																																																																		
VL1019A0	VIBRATION DETERGENT PUMP	1.000	PC																																																																																		
VL1047A1	D6 PIPE HOLDER - D6 J.G. TERMINAL	1.000	PC																																																																																		
VL1054B0	ONE WASHING SYS INLET DISTRIBUTOR	1.000	PC																																																																																		
VL1065A1	1/4 MALE N.O. PRESSURE SWITCH	1.000	PC																																																																																		
VL1102A1	DETERGENT LINE FILTER + BARBED VNR 6 MM	1.000	PC																																																																																		
VL1128A1	D6 BARBED CHECK VALVE	2.000	PC																																																																																		
VL1165A0	BAM-BB6 STRAIGHT FITTING	1.000	PC																																																																																		
VL1166A0	BB6-AR6 L FITTING	3.000	PC																																																																																		
VL1174C0	D1.2 MM CALIBRATED D1.2 MM	1.000	PC																																																																																		



COMPONENT			SPARE PART																																																																							
Code	Description	Image	Code	Description	Kit components																																																																					
VL1166A	BB6-AR6 L FITTING		KVL1212A	EUR COMPACT PLUS CLEANING SYSTEM KIT	<table border="1"> <thead> <tr> <th>Code</th> <th>Description</th> <th>Qty</th> <th>UOM</th> </tr> </thead> <tbody> <tr> <td>VL1185A0</td> <td>2 WAYS PLUS WASHING DISTRIBUTOR</td> <td>1.000</td> <td>PC</td> </tr> <tr> <td>VM2172A0</td> <td>LOCKING CLIP FOR PUMP WITH CIRCUIT</td> <td>6.000</td> <td>PC</td> </tr> </tbody> </table>	Code	Description	Qty	UOM	VL1185A0	2 WAYS PLUS WASHING DISTRIBUTOR	1.000	PC	VM2172A0	LOCKING CLIP FOR PUMP WITH CIRCUIT	6.000	PC																																																									
			Code	Description	Qty	UOM																																																																				
VL1185A0	2 WAYS PLUS WASHING DISTRIBUTOR	1.000	PC																																																																							
VM2172A0	LOCKING CLIP FOR PUMP WITH CIRCUIT	6.000	PC																																																																							
KVL1211A	ONE COMPACT AND 0523-EP WASH. SYSTEM KIT	<table border="1"> <thead> <tr> <th>Code</th> <th>Description</th> <th>Qty</th> <th>UOM</th> </tr> </thead> <tbody> <tr> <td>0H2427A0</td> <td>XECC WASHING CIRCUIT HOLDING PLATE</td> <td>1.000</td> <td>PC</td> </tr> <tr> <td>EL1440A0</td> <td>WATER SELF CLEANING VALVE</td> <td>1.000</td> <td>PC</td> </tr> <tr> <td>GN1526A0</td> <td>INT. D.=6.9 TH=1.8 O-RING</td> <td>3.000</td> <td>PC</td> </tr> <tr> <td>RC1018A0</td> <td>ZINC PLATED D12 ELASTIC CLAMP</td> <td>1.000</td> <td>PC</td> </tr> <tr> <td>RC1019A0</td> <td>D=10 ELASTIC CLAMP</td> <td>14.000</td> <td>PC</td> </tr> <tr> <td>RC1130A0</td> <td>130x2.6 CLAM</td> <td>1.000</td> <td>PC</td> </tr> <tr> <td>RC1242A0</td> <td>D=10 CLOSED CAP</td> <td>2.000</td> <td>PC</td> </tr> <tr> <td>TB1402A0</td> <td>TB2820A-DETE RGENT CIRCUIT-FILTE R PIPE</td> <td>1.000</td> <td>PC</td> </tr> <tr> <td>TB2821A0</td> <td>EPDM 6X10 L=40MM PIPE</td> <td>6.000</td> <td>PC</td> </tr> <tr> <td>TB3004A0</td> <td>TB2820A L=550mm EPDM BLACK PIPE</td> <td>1.000</td> <td>PC</td> </tr> <tr> <td>TB3469A0</td> <td></td> <td>1.000</td> <td>PC</td> </tr> <tr> <td>VI1220A1</td> <td>4,2x12 TCB SELF-TAPPIN G SCREW</td> <td>4.000</td> <td>PC</td> </tr> <tr> <td>VL1019A0</td> <td>VIBRATION DETERGENT PUMP</td> <td>1.000</td> <td>PC</td> </tr> <tr> <td>VL1047A1</td> <td>D6 PIPE HOLDER - D8 J.G. TERMINAL</td> <td>1.000</td> <td>PC</td> </tr> <tr> <td>VL1054B0</td> <td>ONE WASHING SYS INLET DISTRIBUTOR</td> <td>1.000</td> <td>PC</td> </tr> <tr> <td>VL1102A1</td> <td>DETERGENT LINE FILTER + BARBED VNR 6 MM</td> <td>1.000</td> <td>PC</td> </tr> <tr> <td>VL1128A1</td> <td>D6 BARBED CHECK VALVE</td> <td>2.000</td> <td>PC</td> </tr> </tbody> </table>	Code	Description	Qty	UOM	0H2427A0	XECC WASHING CIRCUIT HOLDING PLATE	1.000	PC	EL1440A0	WATER SELF CLEANING VALVE	1.000	PC	GN1526A0	INT. D.=6.9 TH=1.8 O-RING	3.000	PC	RC1018A0	ZINC PLATED D12 ELASTIC CLAMP	1.000	PC	RC1019A0	D=10 ELASTIC CLAMP	14.000	PC	RC1130A0	130x2.6 CLAM	1.000	PC	RC1242A0	D=10 CLOSED CAP	2.000	PC	TB1402A0	TB2820A-DETE RGENT CIRCUIT-FILTE R PIPE	1.000	PC	TB2821A0	EPDM 6X10 L=40MM PIPE	6.000	PC	TB3004A0	TB2820A L=550mm EPDM BLACK PIPE	1.000	PC	TB3469A0		1.000	PC	VI1220A1	4,2x12 TCB SELF-TAPPIN G SCREW	4.000	PC	VL1019A0	VIBRATION DETERGENT PUMP	1.000	PC	VL1047A1	D6 PIPE HOLDER - D8 J.G. TERMINAL	1.000	PC	VL1054B0	ONE WASHING SYS INLET DISTRIBUTOR	1.000	PC	VL1102A1	DETERGENT LINE FILTER + BARBED VNR 6 MM	1.000	PC	VL1128A1	D6 BARBED CHECK VALVE	2.000	PC
Code	Description	Qty	UOM																																																																							
0H2427A0	XECC WASHING CIRCUIT HOLDING PLATE	1.000	PC																																																																							
EL1440A0	WATER SELF CLEANING VALVE	1.000	PC																																																																							
GN1526A0	INT. D.=6.9 TH=1.8 O-RING	3.000	PC																																																																							
RC1018A0	ZINC PLATED D12 ELASTIC CLAMP	1.000	PC																																																																							
RC1019A0	D=10 ELASTIC CLAMP	14.000	PC																																																																							
RC1130A0	130x2.6 CLAM	1.000	PC																																																																							
RC1242A0	D=10 CLOSED CAP	2.000	PC																																																																							
TB1402A0	TB2820A-DETE RGENT CIRCUIT-FILTE R PIPE	1.000	PC																																																																							
TB2821A0	EPDM 6X10 L=40MM PIPE	6.000	PC																																																																							
TB3004A0	TB2820A L=550mm EPDM BLACK PIPE	1.000	PC																																																																							
TB3469A0		1.000	PC																																																																							
VI1220A1	4,2x12 TCB SELF-TAPPIN G SCREW	4.000	PC																																																																							
VL1019A0	VIBRATION DETERGENT PUMP	1.000	PC																																																																							
VL1047A1	D6 PIPE HOLDER - D8 J.G. TERMINAL	1.000	PC																																																																							
VL1054B0	ONE WASHING SYS INLET DISTRIBUTOR	1.000	PC																																																																							
VL1102A1	DETERGENT LINE FILTER + BARBED VNR 6 MM	1.000	PC																																																																							
VL1128A1	D6 BARBED CHECK VALVE	2.000	PC																																																																							



COMPONENT			SPARE PART																																																																						
Code	Description	Image	Code	Description	Kit components																																																																				
VL1166A	BB6-AR6 L FITTING		KVL1211A	ONE COMPACT AND 0523-EP WASH. SYSTEM KIT	<table border="1"> <thead> <tr> <th>Code</th> <th>Description</th> <th>Qty</th> <th>UOM</th> </tr> </thead> <tbody> <tr> <td>VL1165A0</td> <td>BAM-BB6 STRAIGHT FITTING</td> <td>1.000</td> <td>PC</td> </tr> <tr> <td>VL1166A0</td> <td>BB6-AR6 L FITTING</td> <td>1.000</td> <td>PC</td> </tr> <tr> <td>VL1174C0</td> <td>D1.2 MM CALIBRATED D1.2 MM</td> <td>1.000</td> <td>PC</td> </tr> <tr> <td>VL1191A0</td> <td>ONE WASHING DISTRIBUTOR OUTLETS KIT</td> <td>1.000</td> <td>PC</td> </tr> <tr> <td>VM2172A0</td> <td>LOCKING CLIP FOR PUMP WITH CIRCUIT</td> <td>2.000</td> <td>PC</td> </tr> </tbody> </table>	Code	Description	Qty	UOM	VL1165A0	BAM-BB6 STRAIGHT FITTING	1.000	PC	VL1166A0	BB6-AR6 L FITTING	1.000	PC	VL1174C0	D1.2 MM CALIBRATED D1.2 MM	1.000	PC	VL1191A0	ONE WASHING DISTRIBUTOR OUTLETS KIT	1.000	PC	VM2172A0	LOCKING CLIP FOR PUMP WITH CIRCUIT	2.000	PC																																												
Code	Description	Qty	UOM																																																																						
VL1165A0	BAM-BB6 STRAIGHT FITTING	1.000	PC																																																																						
VL1166A0	BB6-AR6 L FITTING	1.000	PC																																																																						
VL1174C0	D1.2 MM CALIBRATED D1.2 MM	1.000	PC																																																																						
VL1191A0	ONE WASHING DISTRIBUTOR OUTLETS KIT	1.000	PC																																																																						
VM2172A0	LOCKING CLIP FOR PUMP WITH CIRCUIT	2.000	PC																																																																						
			KVL1209A	US PLUS 3 ROTOR ARMS WASHING SYSTEM KIT	<table border="1"> <thead> <tr> <th>Code</th> <th>Description</th> <th>Qty</th> <th>UOM</th> </tr> </thead> <tbody> <tr> <td>0H2354A1</td> <td>XEVC-XEVL PLUS WASHING CIRCUIT PLAT</td> <td>1.000</td> <td>PC</td> </tr> <tr> <td>EL1450A0</td> <td>US SELF-CLEANING WATER SOLENOID</td> <td>4.000</td> <td>PC</td> </tr> <tr> <td>GN1526A0</td> <td>INT. D.=6.9 TH=1.8 O-RING</td> <td>9.000</td> <td>PC</td> </tr> <tr> <td>RC1018A0</td> <td>ZINC PLATED D12 ELASTIC CLAMP</td> <td>12.000</td> <td>PC</td> </tr> <tr> <td>RC1019A0</td> <td>D=10 ELASTIC CLAMP</td> <td>15.000</td> <td>PC</td> </tr> <tr> <td>RC1130A0</td> <td>130x2.6 CLAMP</td> <td>1.000</td> <td>PC</td> </tr> <tr> <td>RC1131A0</td> <td>200x2.6 BLACK CLAMP</td> <td>3.000</td> <td>PC</td> </tr> <tr> <td>RC1242A0</td> <td>D=10 CLOSED CAP</td> <td>2.000</td> <td>PC</td> </tr> <tr> <td>RC1356A0</td> <td>"STRAIGHT THREADED FEMALE END 8x1/4" BS</td> <td>1.000</td> <td>PC</td> </tr> <tr> <td>TB2652A0</td> <td></td> <td>1.000</td> <td>PC</td> </tr> <tr> <td>TB2677A0</td> <td></td> <td>1.000</td> <td>PC</td> </tr> <tr> <td>TB2821A0</td> <td>EPDM 6X10 L=40MM PIPE</td> <td>6.000</td> <td>PC</td> </tr> <tr> <td>TB3004A0</td> <td>TB2820A L=550mm EPDM BLACK PIPE</td> <td>2.000</td> <td>PC</td> </tr> <tr> <td>TB3024C0</td> <td></td> <td>3.000</td> <td>PC</td> </tr> <tr> <td>TB3226A0</td> <td></td> <td>1.000</td> <td>PC</td> </tr> <tr> <td>TB3440A0</td> <td>TB3132A L=1050mm EPDM WHITE-BLUE PIPE</td> <td>1.000</td> <td>PC</td> </tr> </tbody> </table>	Code	Description	Qty	UOM	0H2354A1	XEVC-XEVL PLUS WASHING CIRCUIT PLAT	1.000	PC	EL1450A0	US SELF-CLEANING WATER SOLENOID	4.000	PC	GN1526A0	INT. D.=6.9 TH=1.8 O-RING	9.000	PC	RC1018A0	ZINC PLATED D12 ELASTIC CLAMP	12.000	PC	RC1019A0	D=10 ELASTIC CLAMP	15.000	PC	RC1130A0	130x2.6 CLAMP	1.000	PC	RC1131A0	200x2.6 BLACK CLAMP	3.000	PC	RC1242A0	D=10 CLOSED CAP	2.000	PC	RC1356A0	"STRAIGHT THREADED FEMALE END 8x1/4" BS	1.000	PC	TB2652A0		1.000	PC	TB2677A0		1.000	PC	TB2821A0	EPDM 6X10 L=40MM PIPE	6.000	PC	TB3004A0	TB2820A L=550mm EPDM BLACK PIPE	2.000	PC	TB3024C0		3.000	PC	TB3226A0		1.000	PC	TB3440A0	TB3132A L=1050mm EPDM WHITE-BLUE PIPE	1.000	PC
Code	Description	Qty	UOM																																																																						
0H2354A1	XEVC-XEVL PLUS WASHING CIRCUIT PLAT	1.000	PC																																																																						
EL1450A0	US SELF-CLEANING WATER SOLENOID	4.000	PC																																																																						
GN1526A0	INT. D.=6.9 TH=1.8 O-RING	9.000	PC																																																																						
RC1018A0	ZINC PLATED D12 ELASTIC CLAMP	12.000	PC																																																																						
RC1019A0	D=10 ELASTIC CLAMP	15.000	PC																																																																						
RC1130A0	130x2.6 CLAMP	1.000	PC																																																																						
RC1131A0	200x2.6 BLACK CLAMP	3.000	PC																																																																						
RC1242A0	D=10 CLOSED CAP	2.000	PC																																																																						
RC1356A0	"STRAIGHT THREADED FEMALE END 8x1/4" BS	1.000	PC																																																																						
TB2652A0		1.000	PC																																																																						
TB2677A0		1.000	PC																																																																						
TB2821A0	EPDM 6X10 L=40MM PIPE	6.000	PC																																																																						
TB3004A0	TB2820A L=550mm EPDM BLACK PIPE	2.000	PC																																																																						
TB3024C0		3.000	PC																																																																						
TB3226A0		1.000	PC																																																																						
TB3440A0	TB3132A L=1050mm EPDM WHITE-BLUE PIPE	1.000	PC																																																																						



COMPONENT			SPARE PART																																																														
Code	Description	Image	Code	Description	Kit components																																																												
VL1166A	BB6-AR6 L FITTING		KVL1209A	US PLUS 3 ROTOR ARMS WASHING SYSTEM KIT	<table border="1"> <thead> <tr> <th>Code</th> <th>Description</th> <th>Qty</th> <th>UOM</th> </tr> </thead> <tbody> <tr> <td>VL1019A0</td> <td>VIBRATION DETERGENT PUMP</td> <td>1.000</td> <td>PC</td> </tr> <tr> <td>VL1065A1</td> <td>1/4 MALE N.O. PRESSURE SWITCH</td> <td>1.000</td> <td>PC</td> </tr> <tr> <td>VL1102A1</td> <td>DETERGENT LINE FILTER + BARBED VNR 6 MM</td> <td>1.000</td> <td>PC</td> </tr> <tr> <td>VL1127A1</td> <td>6mm BARBED T-SHAPED FITTING</td> <td>2.000</td> <td>PC</td> </tr> <tr> <td>VL1128A1</td> <td>D6 BARBED CHECK VALVE</td> <td>3.000</td> <td>PC</td> </tr> <tr> <td>VL1166A0</td> <td>BB6-AR6 L FITTING</td> <td>4.000</td> <td>PC</td> </tr> <tr> <td>VL1167A2</td> <td>GN21 3 ROTOR ARMS B-B FLOW RESTRICTOR</td> <td>1.000</td> <td>PC</td> </tr> <tr> <td>VL1174C0</td> <td>D1.2 MM CALIBRATED D1.2 MM</td> <td>1.000</td> <td>PC</td> </tr> <tr> <td>VL1185A0</td> <td>2 WAYS PLUS WASHING DISTRIBUTOR</td> <td>1.000</td> <td>PC</td> </tr> <tr> <td>VL1186A0</td> <td>3 WAYS PLUS WASHING DISTRIBUTOR</td> <td>1.000</td> <td>PC</td> </tr> <tr> <td>VL1190A0</td> <td>PLUS WASHING SYSTEM INLET DISTRIBUTOR</td> <td>1.000</td> <td>PC</td> </tr> <tr> <td>VL1214A0</td> <td>BAYONET - 6mm BARBED NRV VALVE</td> <td>1.000</td> <td>PC</td> </tr> <tr> <td>VM1605A0</td> <td>CLIP TWIST LOCK DIAM. 10,2-12,7 MM</td> <td>3.000</td> <td>PC</td> </tr> <tr> <td>VM2172A0</td> <td>LOCKING CLIP FOR PUMP WITH CIRCUIT</td> <td>9.000</td> <td>PC</td> </tr> </tbody> </table>	Code	Description	Qty	UOM	VL1019A0	VIBRATION DETERGENT PUMP	1.000	PC	VL1065A1	1/4 MALE N.O. PRESSURE SWITCH	1.000	PC	VL1102A1	DETERGENT LINE FILTER + BARBED VNR 6 MM	1.000	PC	VL1127A1	6mm BARBED T-SHAPED FITTING	2.000	PC	VL1128A1	D6 BARBED CHECK VALVE	3.000	PC	VL1166A0	BB6-AR6 L FITTING	4.000	PC	VL1167A2	GN21 3 ROTOR ARMS B-B FLOW RESTRICTOR	1.000	PC	VL1174C0	D1.2 MM CALIBRATED D1.2 MM	1.000	PC	VL1185A0	2 WAYS PLUS WASHING DISTRIBUTOR	1.000	PC	VL1186A0	3 WAYS PLUS WASHING DISTRIBUTOR	1.000	PC	VL1190A0	PLUS WASHING SYSTEM INLET DISTRIBUTOR	1.000	PC	VL1214A0	BAYONET - 6mm BARBED NRV VALVE	1.000	PC	VM1605A0	CLIP TWIST LOCK DIAM. 10,2-12,7 MM	3.000	PC	VM2172A0	LOCKING CLIP FOR PUMP WITH CIRCUIT	9.000	PC
Code	Description	Qty	UOM																																																														
VL1019A0	VIBRATION DETERGENT PUMP	1.000	PC																																																														
VL1065A1	1/4 MALE N.O. PRESSURE SWITCH	1.000	PC																																																														
VL1102A1	DETERGENT LINE FILTER + BARBED VNR 6 MM	1.000	PC																																																														
VL1127A1	6mm BARBED T-SHAPED FITTING	2.000	PC																																																														
VL1128A1	D6 BARBED CHECK VALVE	3.000	PC																																																														
VL1166A0	BB6-AR6 L FITTING	4.000	PC																																																														
VL1167A2	GN21 3 ROTOR ARMS B-B FLOW RESTRICTOR	1.000	PC																																																														
VL1174C0	D1.2 MM CALIBRATED D1.2 MM	1.000	PC																																																														
VL1185A0	2 WAYS PLUS WASHING DISTRIBUTOR	1.000	PC																																																														
VL1186A0	3 WAYS PLUS WASHING DISTRIBUTOR	1.000	PC																																																														
VL1190A0	PLUS WASHING SYSTEM INLET DISTRIBUTOR	1.000	PC																																																														
VL1214A0	BAYONET - 6mm BARBED NRV VALVE	1.000	PC																																																														
VM1605A0	CLIP TWIST LOCK DIAM. 10,2-12,7 MM	3.000	PC																																																														
VM2172A0	LOCKING CLIP FOR PUMP WITH CIRCUIT	9.000	PC																																																														
			KVL1208A	US PLUS 2 ROTOR ARMS WASHING SYSTEM KIT	<table border="1"> <thead> <tr> <th>Code</th> <th>Description</th> <th>Qty</th> <th>UOM</th> </tr> </thead> <tbody> <tr> <td>0H2354A1</td> <td>XEVC-XEVL PLUS WASHING CIRCUIT PLAT</td> <td>1.000</td> <td>PC</td> </tr> <tr> <td>EL1450A0</td> <td>US SELF-CLEANING WATER SOLENOID</td> <td>4.000</td> <td>PC</td> </tr> </tbody> </table>	Code	Description	Qty	UOM	0H2354A1	XEVC-XEVL PLUS WASHING CIRCUIT PLAT	1.000	PC	EL1450A0	US SELF-CLEANING WATER SOLENOID	4.000	PC																																																
Code	Description	Qty	UOM																																																														
0H2354A1	XEVC-XEVL PLUS WASHING CIRCUIT PLAT	1.000	PC																																																														
EL1450A0	US SELF-CLEANING WATER SOLENOID	4.000	PC																																																														





COMPONENT			SPARE PART																																																																																		
Code	Description	Image	Code	Description	Kit components																																																																																
VL1166A	BB6-AR6 L FITTING		KVL1208A	US PLUS 2 ROTOR ARMS WASHING SYSTEM KIT	<table border="1"> <thead> <tr> <th>Code</th> <th>Description</th> <th>Qty</th> <th>UOM</th> </tr> </thead> <tbody> <tr> <td>GN1526A0</td> <td>INT. D.=6.9 TH=1.8 O-RIN</td> <td>9.000</td> <td>PC</td> </tr> <tr> <td>RC1018A0</td> <td>ZINC PLATED D12 ELASTIC CLAMP</td> <td>3.000</td> <td>PC</td> </tr> <tr> <td>RC1019A0</td> <td>D=10 ELASTIC CLAMP</td> <td>2.000</td> <td>PC</td> </tr> <tr> <td>RC1130A0</td> <td>130x2.6 CLAM</td> <td>1.000</td> <td>PC</td> </tr> <tr> <td>RC1131A0</td> <td>200x2.6 BLACK CLAMP</td> <td>3.000</td> <td>PC</td> </tr> <tr> <td>RC1242A0</td> <td>D=10 CLOSED CAP</td> <td>2.000</td> <td>PC</td> </tr> <tr> <td>RC1356A0</td> <td>"STRAIGHT THREADED FEMALE END 8x1/4" BS</td> <td>1.000</td> <td>PC</td> </tr> <tr> <td>TB2821A0</td> <td>EPDM 6X10 L=40MM PIPE</td> <td>6.000</td> <td>PC</td> </tr> <tr> <td>TB2994A0</td> <td>HOOD DETERGENT PIPE</td> <td>1.000</td> <td>PC</td> </tr> <tr> <td>TB3004A0</td> <td>TB2820A L=550mm EPDM BLACK PIPE</td> <td>1.000</td> <td>PC</td> </tr> <tr> <td>TB3005B0</td> <td>TB3132A L=550mm EPDM WHITE-BLUE PIPE</td> <td>1.000</td> <td>PC</td> </tr> <tr> <td>TB3440A0</td> <td>TB3132A L=1050mm EPDM WHITE-BLUE PIPE</td> <td>1.000</td> <td>PC</td> </tr> <tr> <td>VL1019A0</td> <td>VIBRATION DETERGENT PUMP</td> <td>1.000</td> <td>PC</td> </tr> <tr> <td>VL1047A1</td> <td>D6 PIPE HOLDER - D8 J.G. TERMINAL</td> <td>1.000</td> <td>PC</td> </tr> <tr> <td>VL1065A1</td> <td>1/4 MALE N.O. PRESSURE SWITCH</td> <td>1.000</td> <td>PC</td> </tr> <tr> <td>VL1102A1</td> <td>DETERGENT LINE FILTER + BARBED VNR 6 MM</td> <td>1.000</td> <td>PC</td> </tr> <tr> <td>VL1128A1</td> <td>D6 BARBED CHECK VALVE</td> <td>2.000</td> <td>PC</td> </tr> <tr> <td>VL1141A1</td> <td>BB6-BB6 STRAIGHT CONNECTION</td> <td>1.000</td> <td>PC</td> </tr> <tr> <td>VL1166A0</td> <td>BB6-AR6 L FITTING</td> <td>4.000</td> <td>PC</td> </tr> </tbody> </table>	Code	Description	Qty	UOM	GN1526A0	INT. D.=6.9 TH=1.8 O-RIN	9.000	PC	RC1018A0	ZINC PLATED D12 ELASTIC CLAMP	3.000	PC	RC1019A0	D=10 ELASTIC CLAMP	2.000	PC	RC1130A0	130x2.6 CLAM	1.000	PC	RC1131A0	200x2.6 BLACK CLAMP	3.000	PC	RC1242A0	D=10 CLOSED CAP	2.000	PC	RC1356A0	"STRAIGHT THREADED FEMALE END 8x1/4" BS	1.000	PC	TB2821A0	EPDM 6X10 L=40MM PIPE	6.000	PC	TB2994A0	HOOD DETERGENT PIPE	1.000	PC	TB3004A0	TB2820A L=550mm EPDM BLACK PIPE	1.000	PC	TB3005B0	TB3132A L=550mm EPDM WHITE-BLUE PIPE	1.000	PC	TB3440A0	TB3132A L=1050mm EPDM WHITE-BLUE PIPE	1.000	PC	VL1019A0	VIBRATION DETERGENT PUMP	1.000	PC	VL1047A1	D6 PIPE HOLDER - D8 J.G. TERMINAL	1.000	PC	VL1065A1	1/4 MALE N.O. PRESSURE SWITCH	1.000	PC	VL1102A1	DETERGENT LINE FILTER + BARBED VNR 6 MM	1.000	PC	VL1128A1	D6 BARBED CHECK VALVE	2.000	PC	VL1141A1	BB6-BB6 STRAIGHT CONNECTION	1.000	PC	VL1166A0	BB6-AR6 L FITTING	4.000	PC
Code	Description	Qty	UOM																																																																																		
GN1526A0	INT. D.=6.9 TH=1.8 O-RIN	9.000	PC																																																																																		
RC1018A0	ZINC PLATED D12 ELASTIC CLAMP	3.000	PC																																																																																		
RC1019A0	D=10 ELASTIC CLAMP	2.000	PC																																																																																		
RC1130A0	130x2.6 CLAM	1.000	PC																																																																																		
RC1131A0	200x2.6 BLACK CLAMP	3.000	PC																																																																																		
RC1242A0	D=10 CLOSED CAP	2.000	PC																																																																																		
RC1356A0	"STRAIGHT THREADED FEMALE END 8x1/4" BS	1.000	PC																																																																																		
TB2821A0	EPDM 6X10 L=40MM PIPE	6.000	PC																																																																																		
TB2994A0	HOOD DETERGENT PIPE	1.000	PC																																																																																		
TB3004A0	TB2820A L=550mm EPDM BLACK PIPE	1.000	PC																																																																																		
TB3005B0	TB3132A L=550mm EPDM WHITE-BLUE PIPE	1.000	PC																																																																																		
TB3440A0	TB3132A L=1050mm EPDM WHITE-BLUE PIPE	1.000	PC																																																																																		
VL1019A0	VIBRATION DETERGENT PUMP	1.000	PC																																																																																		
VL1047A1	D6 PIPE HOLDER - D8 J.G. TERMINAL	1.000	PC																																																																																		
VL1065A1	1/4 MALE N.O. PRESSURE SWITCH	1.000	PC																																																																																		
VL1102A1	DETERGENT LINE FILTER + BARBED VNR 6 MM	1.000	PC																																																																																		
VL1128A1	D6 BARBED CHECK VALVE	2.000	PC																																																																																		
VL1141A1	BB6-BB6 STRAIGHT CONNECTION	1.000	PC																																																																																		
VL1166A0	BB6-AR6 L FITTING	4.000	PC																																																																																		



COMPONENT			SPARE PART																																																		
Code	Description	Image	Code	Description	Kit components																																																
VL1166A	BB6-AR6 L FITTING		KVL1208A	US PLUS 2 ROTOR ARMS WASHING SYSTEM KIT	<table border="1"> <thead> <tr> <th>Code</th> <th>Description</th> <th>Qty</th> <th>UOM</th> </tr> </thead> <tbody> <tr> <td>VL1174C0</td> <td>D1.2 MM CALIBRATED D1.2 MM</td> <td>1.000</td> <td>PC</td> </tr> <tr> <td>VL1186A0</td> <td>3 WAYS PLUS WASHING DISTRIBUTOR</td> <td>1.000</td> <td>PC</td> </tr> <tr> <td>VL1190A0</td> <td>PLUS WASHING SYSTEM INLET DISTRIBUTOR</td> <td>1.000</td> <td>PC</td> </tr> <tr> <td>VL1214A0</td> <td>BAYONET - 6mm BARBED NRV VALVE</td> <td>1.000</td> <td>PC</td> </tr> <tr> <td>VM1605A0</td> <td>CLIP TWIST LOCK DIAM. 10,2-12,7 MM</td> <td>3.000</td> <td>PC</td> </tr> <tr> <td>VM2172A0</td> <td>LOCKING CLIP FOR PUMP WITH CIRCUIT</td> <td>5.000</td> <td>PC</td> </tr> </tbody> </table>	Code	Description	Qty	UOM	VL1174C0	D1.2 MM CALIBRATED D1.2 MM	1.000	PC	VL1186A0	3 WAYS PLUS WASHING DISTRIBUTOR	1.000	PC	VL1190A0	PLUS WASHING SYSTEM INLET DISTRIBUTOR	1.000	PC	VL1214A0	BAYONET - 6mm BARBED NRV VALVE	1.000	PC	VM1605A0	CLIP TWIST LOCK DIAM. 10,2-12,7 MM	3.000	PC	VM2172A0	LOCKING CLIP FOR PUMP WITH CIRCUIT	5.000	PC																				
Code	Description	Qty	UOM																																																		
VL1174C0	D1.2 MM CALIBRATED D1.2 MM	1.000	PC																																																		
VL1186A0	3 WAYS PLUS WASHING DISTRIBUTOR	1.000	PC																																																		
VL1190A0	PLUS WASHING SYSTEM INLET DISTRIBUTOR	1.000	PC																																																		
VL1214A0	BAYONET - 6mm BARBED NRV VALVE	1.000	PC																																																		
VM1605A0	CLIP TWIST LOCK DIAM. 10,2-12,7 MM	3.000	PC																																																		
VM2172A0	LOCKING CLIP FOR PUMP WITH CIRCUIT	5.000	PC																																																		
			KVL1207A	US PLUS 1 ROTOR ARM WASHING SYSTEM KIT	<table border="1"> <thead> <tr> <th>Code</th> <th>Description</th> <th>Qty</th> <th>UOM</th> </tr> </thead> <tbody> <tr> <td>0H2354A1</td> <td>XEVC-XEVL PLUS WASHING CIRCUIT PLAT</td> <td>1.000</td> <td>PC</td> </tr> <tr> <td>EL1450A0</td> <td>US SELF-CLEANIN G WATER SOLENOID</td> <td>3.000</td> <td>PC</td> </tr> <tr> <td>GN1526A0</td> <td>INT. D.=6.9 TH=1.8 O-RIN</td> <td>7.000</td> <td>PC</td> </tr> <tr> <td>RC1018A0</td> <td>ZINC PLATED D12 ELASTIC CLAMP</td> <td>2.000</td> <td>PC</td> </tr> <tr> <td>RC1019A0</td> <td>D=10 ELASTIC CLAMP</td> <td>14.000</td> <td>PC</td> </tr> <tr> <td>RC1130A0</td> <td>130x2,6 CLAM</td> <td>1.000</td> <td>PC</td> </tr> <tr> <td>RC1131A0</td> <td>200x2,6 BLACK CLAMP</td> <td>2.000</td> <td>PC</td> </tr> <tr> <td>RC1242A0</td> <td>D=10 CLOSED CAP</td> <td>2.000</td> <td>PC</td> </tr> <tr> <td>RC1356A0</td> <td>"STRAIGHT THREADED FEMALE END 8x1/4" BS</td> <td>1.000</td> <td>PC</td> </tr> <tr> <td>TB2821A0</td> <td>EPDM 6X10 L=40MM PIPE</td> <td>6.000</td> <td>PC</td> </tr> <tr> <td>TB3004A0</td> <td>TB2820A L=550mm EPDM BLACK PIPE</td> <td>1.000</td> <td>PC</td> </tr> </tbody> </table>	Code	Description	Qty	UOM	0H2354A1	XEVC-XEVL PLUS WASHING CIRCUIT PLAT	1.000	PC	EL1450A0	US SELF-CLEANIN G WATER SOLENOID	3.000	PC	GN1526A0	INT. D.=6.9 TH=1.8 O-RIN	7.000	PC	RC1018A0	ZINC PLATED D12 ELASTIC CLAMP	2.000	PC	RC1019A0	D=10 ELASTIC CLAMP	14.000	PC	RC1130A0	130x2,6 CLAM	1.000	PC	RC1131A0	200x2,6 BLACK CLAMP	2.000	PC	RC1242A0	D=10 CLOSED CAP	2.000	PC	RC1356A0	"STRAIGHT THREADED FEMALE END 8x1/4" BS	1.000	PC	TB2821A0	EPDM 6X10 L=40MM PIPE	6.000	PC	TB3004A0	TB2820A L=550mm EPDM BLACK PIPE	1.000	PC
Code	Description	Qty	UOM																																																		
0H2354A1	XEVC-XEVL PLUS WASHING CIRCUIT PLAT	1.000	PC																																																		
EL1450A0	US SELF-CLEANIN G WATER SOLENOID	3.000	PC																																																		
GN1526A0	INT. D.=6.9 TH=1.8 O-RIN	7.000	PC																																																		
RC1018A0	ZINC PLATED D12 ELASTIC CLAMP	2.000	PC																																																		
RC1019A0	D=10 ELASTIC CLAMP	14.000	PC																																																		
RC1130A0	130x2,6 CLAM	1.000	PC																																																		
RC1131A0	200x2,6 BLACK CLAMP	2.000	PC																																																		
RC1242A0	D=10 CLOSED CAP	2.000	PC																																																		
RC1356A0	"STRAIGHT THREADED FEMALE END 8x1/4" BS	1.000	PC																																																		
TB2821A0	EPDM 6X10 L=40MM PIPE	6.000	PC																																																		
TB3004A0	TB2820A L=550mm EPDM BLACK PIPE	1.000	PC																																																		



COMPONENT			SPARE PART																																																																		
Code	Description	Image	Code	Description	Kit components																																																																
VL1166A	BB6-AR6 L FITTING		KVL1207A	US PLUS 1 ROTOR ARM WASHING SYSTEM KIT	<table border="1"> <thead> <tr> <th>Code</th> <th>Description</th> <th>Qty</th> <th>UOM</th> </tr> </thead> <tbody> <tr> <td>TB3005B0</td> <td>TB3132A L=550mm EPDM WHITE-BLUE PIPE</td> <td>1.000</td> <td>PC</td> </tr> <tr> <td>TB3225B0</td> <td>TB2820A-TAN K-WASHYNG SYS CONNECTION</td> <td>1.000</td> <td>PC</td> </tr> <tr> <td>TB3252A0</td> <td>TB3252A0</td> <td>1.000</td> <td>PC</td> </tr> <tr> <td>VL1019A0</td> <td>VIBRATION DETERGENT PUMP</td> <td>1.000</td> <td>PC</td> </tr> <tr> <td>VL1047A1</td> <td>D6 PIPE HOLDER - D8 J.G. TERMINAL</td> <td>1.000</td> <td>PC</td> </tr> <tr> <td>VL1065A1</td> <td>1/4 MALE N.O. PRESSURE SWITCH</td> <td>1.000</td> <td>PC</td> </tr> <tr> <td>VL1102A1</td> <td>DETERGENT LINE FILTER + BARBED VNR 6 MM</td> <td>1.000</td> <td>PC</td> </tr> <tr> <td>VL1128A1</td> <td>D6 BARBED CHECK VALVE</td> <td>2.000</td> <td>PC</td> </tr> <tr> <td>VL1166A0</td> <td>BB6-AR6 L FITTING</td> <td>3.000</td> <td>PC</td> </tr> <tr> <td>VL1174C0</td> <td>D1.2 MM CALIBRATED D1.2 MM</td> <td>1.000</td> <td>PC</td> </tr> <tr> <td>VL1185A0</td> <td>2 WAYS PLUS WASHING DISTRIBUTOR</td> <td>1.000</td> <td>PC</td> </tr> <tr> <td>VL1190A0</td> <td>PLUS WASHING SYSTEM INLET DISTRIBUTOR</td> <td>1.000</td> <td>PC</td> </tr> <tr> <td>VL1214A0</td> <td>BAYONET - 6mm BARBED NRV VALVE</td> <td>1.000</td> <td>PC</td> </tr> <tr> <td>VM1605A0</td> <td>CLIP TWIST LOCK DIAM. 10,2-12,7 MM</td> <td>3.000</td> <td>PC</td> </tr> <tr> <td>VM2172A0</td> <td>LOCKING CLIP FOR PUMP WITH CIRCUIT</td> <td>3.000</td> <td>PC</td> </tr> </tbody> </table>	Code	Description	Qty	UOM	TB3005B0	TB3132A L=550mm EPDM WHITE-BLUE PIPE	1.000	PC	TB3225B0	TB2820A-TAN K-WASHYNG SYS CONNECTION	1.000	PC	TB3252A0	TB3252A0	1.000	PC	VL1019A0	VIBRATION DETERGENT PUMP	1.000	PC	VL1047A1	D6 PIPE HOLDER - D8 J.G. TERMINAL	1.000	PC	VL1065A1	1/4 MALE N.O. PRESSURE SWITCH	1.000	PC	VL1102A1	DETERGENT LINE FILTER + BARBED VNR 6 MM	1.000	PC	VL1128A1	D6 BARBED CHECK VALVE	2.000	PC	VL1166A0	BB6-AR6 L FITTING	3.000	PC	VL1174C0	D1.2 MM CALIBRATED D1.2 MM	1.000	PC	VL1185A0	2 WAYS PLUS WASHING DISTRIBUTOR	1.000	PC	VL1190A0	PLUS WASHING SYSTEM INLET DISTRIBUTOR	1.000	PC	VL1214A0	BAYONET - 6mm BARBED NRV VALVE	1.000	PC	VM1605A0	CLIP TWIST LOCK DIAM. 10,2-12,7 MM	3.000	PC	VM2172A0	LOCKING CLIP FOR PUMP WITH CIRCUIT	3.000	PC
Code	Description	Qty	UOM																																																																		
TB3005B0	TB3132A L=550mm EPDM WHITE-BLUE PIPE	1.000	PC																																																																		
TB3225B0	TB2820A-TAN K-WASHYNG SYS CONNECTION	1.000	PC																																																																		
TB3252A0	TB3252A0	1.000	PC																																																																		
VL1019A0	VIBRATION DETERGENT PUMP	1.000	PC																																																																		
VL1047A1	D6 PIPE HOLDER - D8 J.G. TERMINAL	1.000	PC																																																																		
VL1065A1	1/4 MALE N.O. PRESSURE SWITCH	1.000	PC																																																																		
VL1102A1	DETERGENT LINE FILTER + BARBED VNR 6 MM	1.000	PC																																																																		
VL1128A1	D6 BARBED CHECK VALVE	2.000	PC																																																																		
VL1166A0	BB6-AR6 L FITTING	3.000	PC																																																																		
VL1174C0	D1.2 MM CALIBRATED D1.2 MM	1.000	PC																																																																		
VL1185A0	2 WAYS PLUS WASHING DISTRIBUTOR	1.000	PC																																																																		
VL1190A0	PLUS WASHING SYSTEM INLET DISTRIBUTOR	1.000	PC																																																																		
VL1214A0	BAYONET - 6mm BARBED NRV VALVE	1.000	PC																																																																		
VM1605A0	CLIP TWIST LOCK DIAM. 10,2-12,7 MM	3.000	PC																																																																		
VM2172A0	LOCKING CLIP FOR PUMP WITH CIRCUIT	3.000	PC																																																																		
			KVL1198A	MM EU HOOD CLEANING SYSTEM KIT	<table border="1"> <thead> <tr> <th>Code</th> <th>Description</th> <th>Qty</th> <th>UOM</th> </tr> </thead> <tbody> <tr> <td>0H2213A1</td> <td>HOOD WATER CIRCUIT PLAT</td> <td>1.000</td> <td>PC</td> </tr> <tr> <td>EL1440A0</td> <td>WATER SELF CLEANING VALVE</td> <td>2.000</td> <td>PC</td> </tr> </tbody> </table>	Code	Description	Qty	UOM	0H2213A1	HOOD WATER CIRCUIT PLAT	1.000	PC	EL1440A0	WATER SELF CLEANING VALVE	2.000	PC																																																				
Code	Description	Qty	UOM																																																																		
0H2213A1	HOOD WATER CIRCUIT PLAT	1.000	PC																																																																		
EL1440A0	WATER SELF CLEANING VALVE	2.000	PC																																																																		

COMPONENT			SPARE PART																																																																																						
Code	Description	Image	Code	Description	Kit components																																																																																				
VL1166A	BB6-AR6 L FITTING		KVL1198A	MM EU HOOD CLEANING SYSTEM KIT	<table border="1"> <thead> <tr> <th>Code</th> <th>Description</th> <th>Qty</th> <th>UOM</th> </tr> </thead> <tbody> <tr> <td>GN1526A0</td> <td>INT. D.=6.9 TH=1.8 O-RING</td> <td>5.000</td> <td>PC</td> </tr> <tr> <td>RC1018A0</td> <td>ZINC PLATED D12 ELASTIC CLAMP</td> <td>4.000</td> <td>PC</td> </tr> <tr> <td>RC1019A0</td> <td>D=10 ELASTIC CLAMP</td> <td>16.000</td> <td>PC</td> </tr> <tr> <td>RC1131A0</td> <td>200x2.6 BLACK CLAMP</td> <td>1.000</td> <td>PC</td> </tr> <tr> <td>RC1242A0</td> <td>D=10 CLOSED CAP</td> <td>2.000</td> <td>PC</td> </tr> <tr> <td>TB2821A0</td> <td>EPDM 6X10 L=40MM PIPE</td> <td>6.000</td> <td>PC</td> </tr> <tr> <td>TB2994A0</td> <td>HOOD DETERGENT PIPE</td> <td>2.000</td> <td>PC</td> </tr> <tr> <td>TB3252A0</td> <td>TB3252A0</td> <td>2.000</td> <td>PC</td> </tr> <tr> <td>VI1220A1</td> <td>4,2x12 TCB SELF-TAPPIN G SCREW</td> <td>3.000</td> <td>PC</td> </tr> <tr> <td>VL1019A0</td> <td>VIBRATION DETERGENT PUMP</td> <td>1.000</td> <td>PC</td> </tr> <tr> <td>VL1047A1</td> <td>D6 PIPE HOLDER - D8 J.G. TERMINAL</td> <td>2.000</td> <td>PC</td> </tr> <tr> <td>VL1054B0</td> <td>ONE WASHING SYS INLET DISTRIBUTOR</td> <td>1.000</td> <td>PC</td> </tr> <tr> <td>VL1102A1</td> <td>DETERGENT LINE FILTER + BARBED VNR 6 MM</td> <td>1.000</td> <td>PC</td> </tr> <tr> <td>VL1127A1</td> <td>6mm BARBED T-SHAPED FITTING</td> <td>1.000</td> <td>PC</td> </tr> <tr> <td>VL1128A1</td> <td>D6 BARBED CHECK VALVE</td> <td>2.000</td> <td>PC</td> </tr> <tr> <td>VL1165A0</td> <td>BAM-BB6 STRAIGHT FITTING</td> <td>1.000</td> <td>PC</td> </tr> <tr> <td>VL1166A0</td> <td>BB6-AR6 L FITTING</td> <td>2.000</td> <td>PC</td> </tr> <tr> <td>VL1174C0</td> <td>D1.2 MM CALIBRATED D1.2 MM</td> <td>1.000</td> <td>PC</td> </tr> <tr> <td>VL1191A0</td> <td>ONE WASHING DISTRIBUTOR OUTLETS KIT</td> <td>1.000</td> <td>PC</td> </tr> <tr> <td>VL1214A0</td> <td>BAYONET - 6mm BARBED NRV VALVE</td> <td>1.000</td> <td>PC</td> </tr> </tbody> </table>	Code	Description	Qty	UOM	GN1526A0	INT. D.=6.9 TH=1.8 O-RING	5.000	PC	RC1018A0	ZINC PLATED D12 ELASTIC CLAMP	4.000	PC	RC1019A0	D=10 ELASTIC CLAMP	16.000	PC	RC1131A0	200x2.6 BLACK CLAMP	1.000	PC	RC1242A0	D=10 CLOSED CAP	2.000	PC	TB2821A0	EPDM 6X10 L=40MM PIPE	6.000	PC	TB2994A0	HOOD DETERGENT PIPE	2.000	PC	TB3252A0	TB3252A0	2.000	PC	VI1220A1	4,2x12 TCB SELF-TAPPIN G SCREW	3.000	PC	VL1019A0	VIBRATION DETERGENT PUMP	1.000	PC	VL1047A1	D6 PIPE HOLDER - D8 J.G. TERMINAL	2.000	PC	VL1054B0	ONE WASHING SYS INLET DISTRIBUTOR	1.000	PC	VL1102A1	DETERGENT LINE FILTER + BARBED VNR 6 MM	1.000	PC	VL1127A1	6mm BARBED T-SHAPED FITTING	1.000	PC	VL1128A1	D6 BARBED CHECK VALVE	2.000	PC	VL1165A0	BAM-BB6 STRAIGHT FITTING	1.000	PC	VL1166A0	BB6-AR6 L FITTING	2.000	PC	VL1174C0	D1.2 MM CALIBRATED D1.2 MM	1.000	PC	VL1191A0	ONE WASHING DISTRIBUTOR OUTLETS KIT	1.000	PC	VL1214A0	BAYONET - 6mm BARBED NRV VALVE	1.000	PC
Code	Description	Qty	UOM																																																																																						
GN1526A0	INT. D.=6.9 TH=1.8 O-RING	5.000	PC																																																																																						
RC1018A0	ZINC PLATED D12 ELASTIC CLAMP	4.000	PC																																																																																						
RC1019A0	D=10 ELASTIC CLAMP	16.000	PC																																																																																						
RC1131A0	200x2.6 BLACK CLAMP	1.000	PC																																																																																						
RC1242A0	D=10 CLOSED CAP	2.000	PC																																																																																						
TB2821A0	EPDM 6X10 L=40MM PIPE	6.000	PC																																																																																						
TB2994A0	HOOD DETERGENT PIPE	2.000	PC																																																																																						
TB3252A0	TB3252A0	2.000	PC																																																																																						
VI1220A1	4,2x12 TCB SELF-TAPPIN G SCREW	3.000	PC																																																																																						
VL1019A0	VIBRATION DETERGENT PUMP	1.000	PC																																																																																						
VL1047A1	D6 PIPE HOLDER - D8 J.G. TERMINAL	2.000	PC																																																																																						
VL1054B0	ONE WASHING SYS INLET DISTRIBUTOR	1.000	PC																																																																																						
VL1102A1	DETERGENT LINE FILTER + BARBED VNR 6 MM	1.000	PC																																																																																						
VL1127A1	6mm BARBED T-SHAPED FITTING	1.000	PC																																																																																						
VL1128A1	D6 BARBED CHECK VALVE	2.000	PC																																																																																						
VL1165A0	BAM-BB6 STRAIGHT FITTING	1.000	PC																																																																																						
VL1166A0	BB6-AR6 L FITTING	2.000	PC																																																																																						
VL1174C0	D1.2 MM CALIBRATED D1.2 MM	1.000	PC																																																																																						
VL1191A0	ONE WASHING DISTRIBUTOR OUTLETS KIT	1.000	PC																																																																																						
VL1214A0	BAYONET - 6mm BARBED NRV VALVE	1.000	PC																																																																																						



COMPONENT			SPARE PART																																																																															
Code	Description	Image	Code	Description	Kit components																																																																													
VL1166A	BB6-AR6 L FITTING		KVL1198A	MM EU HOOD CLEANING SYSTEM KIT	<table border="1"> <thead> <tr> <th>Code</th> <th>Description</th> <th>Qty</th> <th>UOM</th> </tr> </thead> <tbody> <tr> <td>VM1605A0</td> <td>CLIP TWIST LOCK DIAM. 10,2-12,7 MM</td> <td>2.000</td> <td>PC</td> </tr> <tr> <td>VM2172A0</td> <td>LOCKING CLIP FOR PUMP WITH CIRCUIT</td> <td>5.000</td> <td>PC</td> </tr> </tbody> </table>	Code	Description	Qty	UOM	VM1605A0	CLIP TWIST LOCK DIAM. 10,2-12,7 MM	2.000	PC	VM2172A0	LOCKING CLIP FOR PUMP WITH CIRCUIT	5.000	PC																																																																	
			Code	Description	Qty	UOM																																																																												
VM1605A0	CLIP TWIST LOCK DIAM. 10,2-12,7 MM	2.000	PC																																																																															
VM2172A0	LOCKING CLIP FOR PUMP WITH CIRCUIT	5.000	PC																																																																															
KVL1187A	3 ROTOR ARMS PLUS EU CLEANING SYSTEM KIT	<table border="1"> <thead> <tr> <th>Code</th> <th>Description</th> <th>Qty</th> <th>UOM</th> </tr> </thead> <tbody> <tr> <td>0H2354A1</td> <td>XEVC-XEVL PLUS WASHING CIRCUIT PLAT</td> <td>1.000</td> <td>PC</td> </tr> <tr> <td>EL1440A0</td> <td>WATER SELF CLEANING VALVE</td> <td>4.000</td> <td>PC</td> </tr> <tr> <td>GN1526A0</td> <td>INT. D.=6.9 TH=1.8 O-RIN</td> <td>9.000</td> <td>PC</td> </tr> <tr> <td>RC1018A0</td> <td>ZINC PLATED D12 ELASTIC CLAMP</td> <td>11.000</td> <td>PC</td> </tr> <tr> <td>RC1019A0</td> <td>D=10 ELASTIC CLAMP</td> <td>16.000</td> <td>PC</td> </tr> <tr> <td>RC1130A0</td> <td>130x2,6 CLAM</td> <td>1.000</td> <td>PC</td> </tr> <tr> <td>RC1131A0</td> <td>200x2,6 BLACK CLAMP</td> <td>3.000</td> <td>PC</td> </tr> <tr> <td>RC1242A0</td> <td>D=10 CLOSED CAP</td> <td>2.000</td> <td>PC</td> </tr> <tr> <td>RC1356A0</td> <td>"STRAIGHT THREADED FEMALE END 8x1/4" BS</td> <td>1.000</td> <td>PC</td> </tr> <tr> <td>TB2652A0</td> <td></td> <td>1.000</td> <td>PC</td> </tr> <tr> <td>TB2677A0</td> <td></td> <td>1.000</td> <td>PC</td> </tr> <tr> <td>TB2821A0</td> <td>EPDM 6X10 L=40MM PIPE</td> <td>6.000</td> <td>PC</td> </tr> <tr> <td>TB3004A0</td> <td>TB2820A L=550mm EPDM BLACK PIPE</td> <td>2.000</td> <td>PC</td> </tr> <tr> <td>TB3024C0</td> <td></td> <td>3.000</td> <td>PC</td> </tr> <tr> <td>TB3226A0</td> <td></td> <td>1.000</td> <td>PC</td> </tr> <tr> <td>TB3440A0</td> <td>TB3132A L=1050mm EPDM WHITE-BLUE PIPE</td> <td>1.000</td> <td>PC</td> </tr> <tr> <td>VL1019A0</td> <td>VIBRATION DETERGENT PUMP</td> <td>1.000</td> <td>PC</td> </tr> <tr> <td>VL1047A1</td> <td>D6 PIPE HOLDER - D8 J.G. TERMINAL</td> <td>1.000</td> <td>PC</td> </tr> <tr> <td>VL1065A1</td> <td>1/4 MALE N.O. PRESSURE SWITCH</td> <td>1.000</td> <td>PC</td> </tr> </tbody> </table>	Code	Description	Qty	UOM	0H2354A1	XEVC-XEVL PLUS WASHING CIRCUIT PLAT	1.000	PC	EL1440A0	WATER SELF CLEANING VALVE	4.000	PC	GN1526A0	INT. D.=6.9 TH=1.8 O-RIN	9.000	PC	RC1018A0	ZINC PLATED D12 ELASTIC CLAMP	11.000	PC	RC1019A0	D=10 ELASTIC CLAMP	16.000	PC	RC1130A0	130x2,6 CLAM	1.000	PC	RC1131A0	200x2,6 BLACK CLAMP	3.000	PC	RC1242A0	D=10 CLOSED CAP	2.000	PC	RC1356A0	"STRAIGHT THREADED FEMALE END 8x1/4" BS	1.000	PC	TB2652A0		1.000	PC	TB2677A0		1.000	PC	TB2821A0	EPDM 6X10 L=40MM PIPE	6.000	PC	TB3004A0	TB2820A L=550mm EPDM BLACK PIPE	2.000	PC	TB3024C0		3.000	PC	TB3226A0		1.000	PC	TB3440A0	TB3132A L=1050mm EPDM WHITE-BLUE PIPE	1.000	PC	VL1019A0	VIBRATION DETERGENT PUMP	1.000	PC	VL1047A1	D6 PIPE HOLDER - D8 J.G. TERMINAL	1.000	PC	VL1065A1	1/4 MALE N.O. PRESSURE SWITCH	1.000	PC
Code	Description	Qty	UOM																																																																															
0H2354A1	XEVC-XEVL PLUS WASHING CIRCUIT PLAT	1.000	PC																																																																															
EL1440A0	WATER SELF CLEANING VALVE	4.000	PC																																																																															
GN1526A0	INT. D.=6.9 TH=1.8 O-RIN	9.000	PC																																																																															
RC1018A0	ZINC PLATED D12 ELASTIC CLAMP	11.000	PC																																																																															
RC1019A0	D=10 ELASTIC CLAMP	16.000	PC																																																																															
RC1130A0	130x2,6 CLAM	1.000	PC																																																																															
RC1131A0	200x2,6 BLACK CLAMP	3.000	PC																																																																															
RC1242A0	D=10 CLOSED CAP	2.000	PC																																																																															
RC1356A0	"STRAIGHT THREADED FEMALE END 8x1/4" BS	1.000	PC																																																																															
TB2652A0		1.000	PC																																																																															
TB2677A0		1.000	PC																																																																															
TB2821A0	EPDM 6X10 L=40MM PIPE	6.000	PC																																																																															
TB3004A0	TB2820A L=550mm EPDM BLACK PIPE	2.000	PC																																																																															
TB3024C0		3.000	PC																																																																															
TB3226A0		1.000	PC																																																																															
TB3440A0	TB3132A L=1050mm EPDM WHITE-BLUE PIPE	1.000	PC																																																																															
VL1019A0	VIBRATION DETERGENT PUMP	1.000	PC																																																																															
VL1047A1	D6 PIPE HOLDER - D8 J.G. TERMINAL	1.000	PC																																																																															
VL1065A1	1/4 MALE N.O. PRESSURE SWITCH	1.000	PC																																																																															



COMPONENT			SPARE PART																																																																																					
Code	Description	Image	Code	Description	Kit components																																																																																			
VL1166A	BB6-AR6 L FITTING		KVL1187A	3 ROTOR ARMS PLUS EU CLEANING SYSTEM KIT	<table border="1"> <thead> <tr> <th>Code</th> <th>Description</th> <th>Qty</th> <th>UOM</th> </tr> </thead> <tbody> <tr> <td>VL1102A1</td> <td>DETERGENT LINE FILTER + BARBED VNR 6 MM</td> <td>1.000</td> <td>PC</td> </tr> <tr> <td>VL1127A1</td> <td>6mm BARBED T-SHAPED FITTING</td> <td>2.000</td> <td>PC</td> </tr> <tr> <td>VL1128A1</td> <td>D6 BARBED CHECK VALVE</td> <td>3.000</td> <td>PC</td> </tr> <tr> <td>VL1166A0</td> <td>BB6-AR6 L FITTING</td> <td>4.000</td> <td>PC</td> </tr> <tr> <td>VL1167A2</td> <td>GN21 3 ROTOR ARMS B-B FLOW RESTRICTOR</td> <td>1.000</td> <td>PC</td> </tr> <tr> <td>VL1174C0</td> <td>D1.2 MM CALIBRATED D1.2 MM</td> <td>1.000</td> <td>PC</td> </tr> <tr> <td>VL1186A0</td> <td>3 WAYS PLUS WASHING DISTRIBUTOR</td> <td>1.000</td> <td>PC</td> </tr> <tr> <td>VL1190A0</td> <td>PLUS WASHING SYSTEM INLET DISTRIBUTOR</td> <td>1.000</td> <td>PC</td> </tr> <tr> <td>VL1214A0</td> <td>BAYONET - 6mm BARBED NRV VALVE</td> <td>1.000</td> <td>PC</td> </tr> <tr> <td>VM1605A0</td> <td>CLIP TWIST LOCK DIAM. 10,2-12,7 MM</td> <td>3.000</td> <td>PC</td> </tr> <tr> <td>VM2172A0</td> <td>LOCKING CLIP FOR PUMP WITH CIRCUIT</td> <td>5.000</td> <td>PC</td> </tr> </tbody> </table>	Code	Description	Qty	UOM	VL1102A1	DETERGENT LINE FILTER + BARBED VNR 6 MM	1.000	PC	VL1127A1	6mm BARBED T-SHAPED FITTING	2.000	PC	VL1128A1	D6 BARBED CHECK VALVE	3.000	PC	VL1166A0	BB6-AR6 L FITTING	4.000	PC	VL1167A2	GN21 3 ROTOR ARMS B-B FLOW RESTRICTOR	1.000	PC	VL1174C0	D1.2 MM CALIBRATED D1.2 MM	1.000	PC	VL1186A0	3 WAYS PLUS WASHING DISTRIBUTOR	1.000	PC	VL1190A0	PLUS WASHING SYSTEM INLET DISTRIBUTOR	1.000	PC	VL1214A0	BAYONET - 6mm BARBED NRV VALVE	1.000	PC	VM1605A0	CLIP TWIST LOCK DIAM. 10,2-12,7 MM	3.000	PC	VM2172A0	LOCKING CLIP FOR PUMP WITH CIRCUIT	5.000	PC	KVL1184A	2 ROTOR ARMS PLUS EU CLEANING SYSTEM KIT	<table border="1"> <thead> <tr> <th>Code</th> <th>Description</th> <th>Qty</th> <th>UOM</th> </tr> </thead> <tbody> <tr> <td>0H2354A1</td> <td>XEVC-XEVL PLUS WASHING CIRCUIT PLAT</td> <td>1.000</td> <td>PC</td> </tr> <tr> <td>EL1440A0</td> <td>WATER SELF CLEANING VALVE</td> <td>4.000</td> <td>PC</td> </tr> <tr> <td>GN1526A0</td> <td>INT. D.=6.9 TH=1.8 O-RIN</td> <td>9.000</td> <td>PC</td> </tr> <tr> <td>RC1018A0</td> <td>ZINC PLATED D12 ELASTIC CLAMP</td> <td>3.000</td> <td>PC</td> </tr> <tr> <td>RC1019A0</td> <td>D=10 ELASTIC CLAMP</td> <td>15.000</td> <td>PC</td> </tr> <tr> <td>RC1130A0</td> <td>130x2,6 CLAM</td> <td>1.000</td> <td>PC</td> </tr> <tr> <td>RC1131A0</td> <td>200x2,6 BLACK CLAMP</td> <td>3.000</td> <td>PC</td> </tr> </tbody> </table>	Code	Description	Qty	UOM	0H2354A1	XEVC-XEVL PLUS WASHING CIRCUIT PLAT	1.000	PC	EL1440A0	WATER SELF CLEANING VALVE	4.000	PC	GN1526A0	INT. D.=6.9 TH=1.8 O-RIN	9.000	PC	RC1018A0	ZINC PLATED D12 ELASTIC CLAMP	3.000	PC	RC1019A0	D=10 ELASTIC CLAMP	15.000	PC	RC1130A0	130x2,6 CLAM	1.000	PC	RC1131A0	200x2,6 BLACK CLAMP	3.000	PC
			Code	Description	Qty	UOM																																																																																		
VL1102A1	DETERGENT LINE FILTER + BARBED VNR 6 MM	1.000	PC																																																																																					
VL1127A1	6mm BARBED T-SHAPED FITTING	2.000	PC																																																																																					
VL1128A1	D6 BARBED CHECK VALVE	3.000	PC																																																																																					
VL1166A0	BB6-AR6 L FITTING	4.000	PC																																																																																					
VL1167A2	GN21 3 ROTOR ARMS B-B FLOW RESTRICTOR	1.000	PC																																																																																					
VL1174C0	D1.2 MM CALIBRATED D1.2 MM	1.000	PC																																																																																					
VL1186A0	3 WAYS PLUS WASHING DISTRIBUTOR	1.000	PC																																																																																					
VL1190A0	PLUS WASHING SYSTEM INLET DISTRIBUTOR	1.000	PC																																																																																					
VL1214A0	BAYONET - 6mm BARBED NRV VALVE	1.000	PC																																																																																					
VM1605A0	CLIP TWIST LOCK DIAM. 10,2-12,7 MM	3.000	PC																																																																																					
VM2172A0	LOCKING CLIP FOR PUMP WITH CIRCUIT	5.000	PC																																																																																					
Code	Description	Qty	UOM																																																																																					
0H2354A1	XEVC-XEVL PLUS WASHING CIRCUIT PLAT	1.000	PC																																																																																					
EL1440A0	WATER SELF CLEANING VALVE	4.000	PC																																																																																					
GN1526A0	INT. D.=6.9 TH=1.8 O-RIN	9.000	PC																																																																																					
RC1018A0	ZINC PLATED D12 ELASTIC CLAMP	3.000	PC																																																																																					
RC1019A0	D=10 ELASTIC CLAMP	15.000	PC																																																																																					
RC1130A0	130x2,6 CLAM	1.000	PC																																																																																					
RC1131A0	200x2,6 BLACK CLAMP	3.000	PC																																																																																					

COMPONENT			SPARE PART																																																																						
Code	Description	Image	Code	Description	Kit components																																																																				
VL1166A	BB6-AR6 L FITTING		KVL1184A	2 ROTOR ARMS PLUS EU CLEANING SYSTEM KIT	<table border="1"> <thead> <tr> <th>Code</th> <th>Description</th> <th>Qty</th> <th>UOM</th> </tr> </thead> <tbody> <tr> <td>RC1242A0</td> <td>D=10 CLOSED CAP</td> <td>2.000</td> <td>PC</td> </tr> <tr> <td>RC1356A0</td> <td>"STRAIGHT THREADED FEMALE END 8x1/4" BS</td> <td>1.000</td> <td>PC</td> </tr> <tr> <td>TB2821A0</td> <td>EPDM 6X10 L=40MM PIPE</td> <td>6.000</td> <td>PC</td> </tr> <tr> <td>TB2994A0</td> <td>HOOD DETERGENT PIPE</td> <td>1.000</td> <td>PC</td> </tr> <tr> <td>TB3004A0</td> <td>TB2820A L=550mm EPDM BLACK PIPE</td> <td>2.000</td> <td>PC</td> </tr> <tr> <td>TB3005B0</td> <td>TB3132A L=550mm EPDM WHITE-BLUE PIPE</td> <td>1.000</td> <td>PC</td> </tr> <tr> <td>TB3440A0</td> <td>TB3132A L=1050mm EPDM WHITE-BLUE PIPE</td> <td>1.000</td> <td>PC</td> </tr> <tr> <td>VL1019A0</td> <td>VIBRATION DETERGENT PUMP</td> <td>1.000</td> <td>PC</td> </tr> <tr> <td>VL1047A1</td> <td>D6 PIPE HOLDER - D8 J.G. TERMINAL</td> <td>1.000</td> <td>PC</td> </tr> <tr> <td>VL1065A1</td> <td>1/4 MALE N.O. PRESSURE SWITCH</td> <td>1.000</td> <td>PC</td> </tr> <tr> <td>VL1102A1</td> <td>DETERGENT LINE FILTER + BARBED VNR 6 MM</td> <td>1.000</td> <td>PC</td> </tr> <tr> <td>VL1128A1</td> <td>D6 BARBED CHECK VALVE</td> <td>2.000</td> <td>PC</td> </tr> <tr> <td>VL1141A1</td> <td>BB6-BB6 STRAIGHT CONNECTION</td> <td>1.000</td> <td>PC</td> </tr> <tr> <td>VL1166A0</td> <td>BB6-AR6 L FITTING</td> <td>4.000</td> <td>PC</td> </tr> <tr> <td>VL1174C0</td> <td>D1.2 MM CALIBRATED D1.2 MM</td> <td>1.000</td> <td>PC</td> </tr> <tr> <td>VL1186A0</td> <td>3 WAYS PLUS WASHING DISTRIBUTOR</td> <td>1.000</td> <td>PC</td> </tr> </tbody> </table>	Code	Description	Qty	UOM	RC1242A0	D=10 CLOSED CAP	2.000	PC	RC1356A0	"STRAIGHT THREADED FEMALE END 8x1/4" BS	1.000	PC	TB2821A0	EPDM 6X10 L=40MM PIPE	6.000	PC	TB2994A0	HOOD DETERGENT PIPE	1.000	PC	TB3004A0	TB2820A L=550mm EPDM BLACK PIPE	2.000	PC	TB3005B0	TB3132A L=550mm EPDM WHITE-BLUE PIPE	1.000	PC	TB3440A0	TB3132A L=1050mm EPDM WHITE-BLUE PIPE	1.000	PC	VL1019A0	VIBRATION DETERGENT PUMP	1.000	PC	VL1047A1	D6 PIPE HOLDER - D8 J.G. TERMINAL	1.000	PC	VL1065A1	1/4 MALE N.O. PRESSURE SWITCH	1.000	PC	VL1102A1	DETERGENT LINE FILTER + BARBED VNR 6 MM	1.000	PC	VL1128A1	D6 BARBED CHECK VALVE	2.000	PC	VL1141A1	BB6-BB6 STRAIGHT CONNECTION	1.000	PC	VL1166A0	BB6-AR6 L FITTING	4.000	PC	VL1174C0	D1.2 MM CALIBRATED D1.2 MM	1.000	PC	VL1186A0	3 WAYS PLUS WASHING DISTRIBUTOR	1.000	PC
Code	Description	Qty	UOM																																																																						
RC1242A0	D=10 CLOSED CAP	2.000	PC																																																																						
RC1356A0	"STRAIGHT THREADED FEMALE END 8x1/4" BS	1.000	PC																																																																						
TB2821A0	EPDM 6X10 L=40MM PIPE	6.000	PC																																																																						
TB2994A0	HOOD DETERGENT PIPE	1.000	PC																																																																						
TB3004A0	TB2820A L=550mm EPDM BLACK PIPE	2.000	PC																																																																						
TB3005B0	TB3132A L=550mm EPDM WHITE-BLUE PIPE	1.000	PC																																																																						
TB3440A0	TB3132A L=1050mm EPDM WHITE-BLUE PIPE	1.000	PC																																																																						
VL1019A0	VIBRATION DETERGENT PUMP	1.000	PC																																																																						
VL1047A1	D6 PIPE HOLDER - D8 J.G. TERMINAL	1.000	PC																																																																						
VL1065A1	1/4 MALE N.O. PRESSURE SWITCH	1.000	PC																																																																						
VL1102A1	DETERGENT LINE FILTER + BARBED VNR 6 MM	1.000	PC																																																																						
VL1128A1	D6 BARBED CHECK VALVE	2.000	PC																																																																						
VL1141A1	BB6-BB6 STRAIGHT CONNECTION	1.000	PC																																																																						
VL1166A0	BB6-AR6 L FITTING	4.000	PC																																																																						
VL1174C0	D1.2 MM CALIBRATED D1.2 MM	1.000	PC																																																																						
VL1186A0	3 WAYS PLUS WASHING DISTRIBUTOR	1.000	PC																																																																						



COMPONENT			SPARE PART																																																											
Code	Description	Image	Code	Description	Kit components																																																									
VL1166A	BB6-AR6 L FITTING		KVL1184A	2 ROTOR ARMS PLUS EU CLEANING SYSTEM KIT	<table border="1"> <thead> <tr> <th>Code</th> <th>Description</th> <th>Qty</th> <th>UOM</th> </tr> </thead> <tbody> <tr> <td>VL1190A0</td> <td>PLUS WASHING SYSTEM INLET DISTRIBUTOR</td> <td>1.000</td> <td>PC</td> </tr> <tr> <td>VL1214A0</td> <td>BAYONET - 6mm BARBED NRV VALVE</td> <td>1.000</td> <td>PC</td> </tr> <tr> <td>VM1605A0</td> <td>CLIP TWIST LOCK DIAM. 10,2-12,7 MM</td> <td>3.000</td> <td>PC</td> </tr> <tr> <td>VM2172A0</td> <td>LOCKING CLIP FOR PUMP WITH CIRCUIT</td> <td>5.000</td> <td>PC</td> </tr> </tbody> </table>	Code	Description	Qty	UOM	VL1190A0	PLUS WASHING SYSTEM INLET DISTRIBUTOR	1.000	PC	VL1214A0	BAYONET - 6mm BARBED NRV VALVE	1.000	PC	VM1605A0	CLIP TWIST LOCK DIAM. 10,2-12,7 MM	3.000	PC	VM2172A0	LOCKING CLIP FOR PUMP WITH CIRCUIT	5.000	PC																																					
			Code	Description	Qty	UOM																																																								
VL1190A0	PLUS WASHING SYSTEM INLET DISTRIBUTOR	1.000	PC																																																											
VL1214A0	BAYONET - 6mm BARBED NRV VALVE	1.000	PC																																																											
VM1605A0	CLIP TWIST LOCK DIAM. 10,2-12,7 MM	3.000	PC																																																											
VM2172A0	LOCKING CLIP FOR PUMP WITH CIRCUIT	5.000	PC																																																											
KVL1183A	1 ROTOR ARM PLUS CLEANING SYSTEM KIT	<table border="1"> <thead> <tr> <th>Code</th> <th>Description</th> <th>Qty</th> <th>UOM</th> </tr> </thead> <tbody> <tr> <td>0H2354A1</td> <td>XEVC-XEVL PLUS WASHING CIRCUIT PLAT</td> <td>1.000</td> <td>PC</td> </tr> <tr> <td>EL1440A0</td> <td>WATER SELF CLEANING VALVE</td> <td>3.000</td> <td>PC</td> </tr> <tr> <td>GN1526A0</td> <td>INT. D.=6.9 TH=1.8 O-RIN</td> <td>7.000</td> <td>PC</td> </tr> <tr> <td>RC1018A0</td> <td>ZINC PLATED D12 ELASTIC CLAMP</td> <td>2.000</td> <td>PC</td> </tr> <tr> <td>RC1019A0</td> <td>D=10 ELASTIC CLAMP</td> <td>14.000</td> <td>PC</td> </tr> <tr> <td>RC1130A0</td> <td>130x2.6 CLAM</td> <td>1.000</td> <td>PC</td> </tr> <tr> <td>RC1131A0</td> <td>200x2.6 BLACK CLAMP</td> <td>2.000</td> <td>PC</td> </tr> <tr> <td>RC1242A0</td> <td>D=10 CLOSED CAP</td> <td>2.000</td> <td>PC</td> </tr> <tr> <td>RC1356A0</td> <td>"STRAIGHT THREADED FEMALE END 8x1/4" BS</td> <td>1.000</td> <td>PC</td> </tr> <tr> <td>TB2821A0</td> <td>EPDM 6X10 L=40MM PIPE</td> <td>6.000</td> <td>PC</td> </tr> <tr> <td>TB3004A0</td> <td>TB2820A L=550mm EPDM BLACK PIPE</td> <td>1.000</td> <td>PC</td> </tr> <tr> <td>TB3005B0</td> <td>TB3132A L=550mm EPDM WHITE-BLUE PIPE</td> <td>1.000</td> <td>PC</td> </tr> <tr> <td>TB3225B0</td> <td>TB2820A-TAN K-WASHYNG SYS CONNECTION</td> <td>1.000</td> <td>PC</td> </tr> <tr> <td>TB3252A0</td> <td>TB3252A0</td> <td>1.000</td> <td>PC</td> </tr> </tbody> </table>	Code	Description	Qty	UOM	0H2354A1	XEVC-XEVL PLUS WASHING CIRCUIT PLAT	1.000	PC	EL1440A0	WATER SELF CLEANING VALVE	3.000	PC	GN1526A0	INT. D.=6.9 TH=1.8 O-RIN	7.000	PC	RC1018A0	ZINC PLATED D12 ELASTIC CLAMP	2.000	PC	RC1019A0	D=10 ELASTIC CLAMP	14.000	PC	RC1130A0	130x2.6 CLAM	1.000	PC	RC1131A0	200x2.6 BLACK CLAMP	2.000	PC	RC1242A0	D=10 CLOSED CAP	2.000	PC	RC1356A0	"STRAIGHT THREADED FEMALE END 8x1/4" BS	1.000	PC	TB2821A0	EPDM 6X10 L=40MM PIPE	6.000	PC	TB3004A0	TB2820A L=550mm EPDM BLACK PIPE	1.000	PC	TB3005B0	TB3132A L=550mm EPDM WHITE-BLUE PIPE	1.000	PC	TB3225B0	TB2820A-TAN K-WASHYNG SYS CONNECTION	1.000	PC	TB3252A0	TB3252A0	1.000	PC
Code	Description	Qty	UOM																																																											
0H2354A1	XEVC-XEVL PLUS WASHING CIRCUIT PLAT	1.000	PC																																																											
EL1440A0	WATER SELF CLEANING VALVE	3.000	PC																																																											
GN1526A0	INT. D.=6.9 TH=1.8 O-RIN	7.000	PC																																																											
RC1018A0	ZINC PLATED D12 ELASTIC CLAMP	2.000	PC																																																											
RC1019A0	D=10 ELASTIC CLAMP	14.000	PC																																																											
RC1130A0	130x2.6 CLAM	1.000	PC																																																											
RC1131A0	200x2.6 BLACK CLAMP	2.000	PC																																																											
RC1242A0	D=10 CLOSED CAP	2.000	PC																																																											
RC1356A0	"STRAIGHT THREADED FEMALE END 8x1/4" BS	1.000	PC																																																											
TB2821A0	EPDM 6X10 L=40MM PIPE	6.000	PC																																																											
TB3004A0	TB2820A L=550mm EPDM BLACK PIPE	1.000	PC																																																											
TB3005B0	TB3132A L=550mm EPDM WHITE-BLUE PIPE	1.000	PC																																																											
TB3225B0	TB2820A-TAN K-WASHYNG SYS CONNECTION	1.000	PC																																																											
TB3252A0	TB3252A0	1.000	PC																																																											







COMPONENT			SPARE PART																																																						
Code	Description	Image	Code	Description	Kit components																																																				
VL1166A	BB6-AR6 L FITTING		KVL1183A	1 ROTOR ARM PLUS CLEANING SYSTEM KIT	<table border="1"> <thead> <tr> <th>Code</th> <th>Description</th> <th>Qty</th> <th>UOM</th> </tr> </thead> <tbody> <tr> <td>VL1019A0</td> <td>VIBRATION DETERGENT PUMP</td> <td>1.000</td> <td>PC</td> </tr> <tr> <td>VL1047A1</td> <td>D6 PIPE HOLDER - D8 J.G. TERMINAL</td> <td>1.000</td> <td>PC</td> </tr> <tr> <td>VL1065A1</td> <td>1/4 MALE N.O. PRESSURE SWITCH</td> <td>1.000</td> <td>PC</td> </tr> <tr> <td>VL1102A1</td> <td>DETERGENT LINE FILTER + BARBED VNR 6 MM</td> <td>1.000</td> <td>PC</td> </tr> <tr> <td>VL1128A1</td> <td>D6 BARBED CHECK VALVE</td> <td>2.000</td> <td>PC</td> </tr> <tr> <td>VL1166A0</td> <td>BB6-AR6 L FITTING</td> <td>3.000</td> <td>PC</td> </tr> <tr> <td>VL1174C0</td> <td>D1.2 MM CALIBRATED D1.2 MM</td> <td>1.000</td> <td>PC</td> </tr> <tr> <td>VL1185A0</td> <td>2 WAYS PLUS WASHING DISTRIBUTOR</td> <td>1.000</td> <td>PC</td> </tr> <tr> <td>VL1190A0</td> <td>PLUS WASHING SYSTEM INLET DISTRIBUTOR</td> <td>1.000</td> <td>PC</td> </tr> <tr> <td>VL1214A0</td> <td>BAYONET - 6mm BARBED NRV VALVE</td> <td>1.000</td> <td>PC</td> </tr> <tr> <td>VM1605A0</td> <td>CLIP TWIST LOCK DIAM. 10,2-12,7 MM</td> <td>3.000</td> <td>PC</td> </tr> <tr> <td>VM2172A0</td> <td>LOCKING CLIP FOR PUMP WITH CIRCUIT</td> <td>4.000</td> <td>PC</td> </tr> </tbody> </table>	Code	Description	Qty	UOM	VL1019A0	VIBRATION DETERGENT PUMP	1.000	PC	VL1047A1	D6 PIPE HOLDER - D8 J.G. TERMINAL	1.000	PC	VL1065A1	1/4 MALE N.O. PRESSURE SWITCH	1.000	PC	VL1102A1	DETERGENT LINE FILTER + BARBED VNR 6 MM	1.000	PC	VL1128A1	D6 BARBED CHECK VALVE	2.000	PC	VL1166A0	BB6-AR6 L FITTING	3.000	PC	VL1174C0	D1.2 MM CALIBRATED D1.2 MM	1.000	PC	VL1185A0	2 WAYS PLUS WASHING DISTRIBUTOR	1.000	PC	VL1190A0	PLUS WASHING SYSTEM INLET DISTRIBUTOR	1.000	PC	VL1214A0	BAYONET - 6mm BARBED NRV VALVE	1.000	PC	VM1605A0	CLIP TWIST LOCK DIAM. 10,2-12,7 MM	3.000	PC	VM2172A0	LOCKING CLIP FOR PUMP WITH CIRCUIT	4.000	PC
Code	Description	Qty	UOM																																																						
VL1019A0	VIBRATION DETERGENT PUMP	1.000	PC																																																						
VL1047A1	D6 PIPE HOLDER - D8 J.G. TERMINAL	1.000	PC																																																						
VL1065A1	1/4 MALE N.O. PRESSURE SWITCH	1.000	PC																																																						
VL1102A1	DETERGENT LINE FILTER + BARBED VNR 6 MM	1.000	PC																																																						
VL1128A1	D6 BARBED CHECK VALVE	2.000	PC																																																						
VL1166A0	BB6-AR6 L FITTING	3.000	PC																																																						
VL1174C0	D1.2 MM CALIBRATED D1.2 MM	1.000	PC																																																						
VL1185A0	2 WAYS PLUS WASHING DISTRIBUTOR	1.000	PC																																																						
VL1190A0	PLUS WASHING SYSTEM INLET DISTRIBUTOR	1.000	PC																																																						
VL1214A0	BAYONET - 6mm BARBED NRV VALVE	1.000	PC																																																						
VM1605A0	CLIP TWIST LOCK DIAM. 10,2-12,7 MM	3.000	PC																																																						
VM2172A0	LOCKING CLIP FOR PUMP WITH CIRCUIT	4.000	PC																																																						
			KVL1182A	ONE 1ROT CLEANING SYSTEM KIT (0311 EXC.)	<table border="1"> <thead> <tr> <th>Code</th> <th>Description</th> <th>Qty</th> <th>UOM</th> </tr> </thead> <tbody> <tr> <td>0H2202A1</td> <td>ONE WASHING WITH STEAM VALVE SUPPORT</td> <td>1.000</td> <td>PC</td> </tr> <tr> <td>EL1440A0</td> <td>WATER SELF CLEANING VALVE</td> <td>1.000</td> <td>PC</td> </tr> <tr> <td>GN1526A0</td> <td>INT. D.=6.9 TH=1.8 O-RIN</td> <td>3.000</td> <td>PC</td> </tr> <tr> <td>RC1018A0</td> <td>ZINC PLATED D12 ELASTIC CLAMP</td> <td>1.000</td> <td>PC</td> </tr> <tr> <td>RC1019A0</td> <td>D=10 ELASTIC CLAMP</td> <td>14.000</td> <td>PC</td> </tr> <tr> <td>RC1130A0</td> <td>130x2,6 CLAM</td> <td>2.000</td> <td>PC</td> </tr> </tbody> </table>	Code	Description	Qty	UOM	0H2202A1	ONE WASHING WITH STEAM VALVE SUPPORT	1.000	PC	EL1440A0	WATER SELF CLEANING VALVE	1.000	PC	GN1526A0	INT. D.=6.9 TH=1.8 O-RIN	3.000	PC	RC1018A0	ZINC PLATED D12 ELASTIC CLAMP	1.000	PC	RC1019A0	D=10 ELASTIC CLAMP	14.000	PC	RC1130A0	130x2,6 CLAM	2.000	PC																								
Code	Description	Qty	UOM																																																						
0H2202A1	ONE WASHING WITH STEAM VALVE SUPPORT	1.000	PC																																																						
EL1440A0	WATER SELF CLEANING VALVE	1.000	PC																																																						
GN1526A0	INT. D.=6.9 TH=1.8 O-RIN	3.000	PC																																																						
RC1018A0	ZINC PLATED D12 ELASTIC CLAMP	1.000	PC																																																						
RC1019A0	D=10 ELASTIC CLAMP	14.000	PC																																																						
RC1130A0	130x2,6 CLAM	2.000	PC																																																						

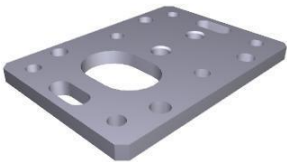

COMPONENT			SPARE PART																																																																						
Code	Description	Image	Code	Description	Kit components																																																																				
VL1166A	BB6-AR6 L FITTING		KVL1182A	ONE 1ROT CLEANING SYSTEM KIT (0311 EXC.)	<table border="1"> <thead> <tr> <th>Code</th> <th>Description</th> <th>Qty</th> <th>UOM</th> </tr> </thead> <tbody> <tr> <td>RC1242A0</td> <td>D=10 CLOSED CAP</td> <td>2.000</td> <td>PC</td> </tr> <tr> <td>TB2821A0</td> <td>EPDM 6X10 L=40MM PIPE</td> <td>6.000</td> <td>PC</td> </tr> <tr> <td>TB3004A0</td> <td>TB2820A L=550mm EPDM BLACK PIPE</td> <td>1.000</td> <td>PC</td> </tr> <tr> <td>TB3009B0</td> <td>TB3132A-ONE OVEN WASHING INLET</td> <td>1.000</td> <td>PC</td> </tr> <tr> <td>TB3225B0</td> <td>TB2820A-TAN K-WASHYNG SYS CONNECTION</td> <td>1.000</td> <td>PC</td> </tr> <tr> <td>VI1220A1</td> <td>4,2x12 TCB SELF-TAPPIN G SCREW</td> <td>1.000</td> <td>PC</td> </tr> <tr> <td>VL1019A0</td> <td>VIBRATION DETERGENT PUMP</td> <td>1.000</td> <td>PC</td> </tr> <tr> <td>VL1047A1</td> <td>D6 PIPE HOLDER - D8 J.G. TERMINAL</td> <td>1.000</td> <td>PC</td> </tr> <tr> <td>VL1054B0</td> <td>ONE WASHING SYS INLET DISTRIBUTOR</td> <td>1.000</td> <td>PC</td> </tr> <tr> <td>VL1102A1</td> <td>DETERGENT LINE FILTER + BARBED VNR 6 MM</td> <td>1.000</td> <td>PC</td> </tr> <tr> <td>VL1128A1</td> <td>D6 BARBED CHECK VALVE</td> <td>2.000</td> <td>PC</td> </tr> <tr> <td>VL1166A0</td> <td>BB6-AR6 L FITTING</td> <td>1.000</td> <td>PC</td> </tr> <tr> <td>VL1174C0</td> <td>D1.2 MM CALIBRATED D1.2 MM</td> <td>1.000</td> <td>PC</td> </tr> <tr> <td>VL1191A0</td> <td>ONE WASHING DISTRIBUTOR OUTLETS KIT</td> <td>1.000</td> <td>PC</td> </tr> <tr> <td>VL1214A0</td> <td>BAYONET - 6mm BARBED NRV VALVE</td> <td>1.000</td> <td>PC</td> </tr> <tr> <td>VM2172A0</td> <td>LOCKING CLIP FOR PUMP WITH CIRCUIT</td> <td>2.000</td> <td>PC</td> </tr> </tbody> </table>	Code	Description	Qty	UOM	RC1242A0	D=10 CLOSED CAP	2.000	PC	TB2821A0	EPDM 6X10 L=40MM PIPE	6.000	PC	TB3004A0	TB2820A L=550mm EPDM BLACK PIPE	1.000	PC	TB3009B0	TB3132A-ONE OVEN WASHING INLET	1.000	PC	TB3225B0	TB2820A-TAN K-WASHYNG SYS CONNECTION	1.000	PC	VI1220A1	4,2x12 TCB SELF-TAPPIN G SCREW	1.000	PC	VL1019A0	VIBRATION DETERGENT PUMP	1.000	PC	VL1047A1	D6 PIPE HOLDER - D8 J.G. TERMINAL	1.000	PC	VL1054B0	ONE WASHING SYS INLET DISTRIBUTOR	1.000	PC	VL1102A1	DETERGENT LINE FILTER + BARBED VNR 6 MM	1.000	PC	VL1128A1	D6 BARBED CHECK VALVE	2.000	PC	VL1166A0	BB6-AR6 L FITTING	1.000	PC	VL1174C0	D1.2 MM CALIBRATED D1.2 MM	1.000	PC	VL1191A0	ONE WASHING DISTRIBUTOR OUTLETS KIT	1.000	PC	VL1214A0	BAYONET - 6mm BARBED NRV VALVE	1.000	PC	VM2172A0	LOCKING CLIP FOR PUMP WITH CIRCUIT	2.000	PC
Code	Description	Qty	UOM																																																																						
RC1242A0	D=10 CLOSED CAP	2.000	PC																																																																						
TB2821A0	EPDM 6X10 L=40MM PIPE	6.000	PC																																																																						
TB3004A0	TB2820A L=550mm EPDM BLACK PIPE	1.000	PC																																																																						
TB3009B0	TB3132A-ONE OVEN WASHING INLET	1.000	PC																																																																						
TB3225B0	TB2820A-TAN K-WASHYNG SYS CONNECTION	1.000	PC																																																																						
VI1220A1	4,2x12 TCB SELF-TAPPIN G SCREW	1.000	PC																																																																						
VL1019A0	VIBRATION DETERGENT PUMP	1.000	PC																																																																						
VL1047A1	D6 PIPE HOLDER - D8 J.G. TERMINAL	1.000	PC																																																																						
VL1054B0	ONE WASHING SYS INLET DISTRIBUTOR	1.000	PC																																																																						
VL1102A1	DETERGENT LINE FILTER + BARBED VNR 6 MM	1.000	PC																																																																						
VL1128A1	D6 BARBED CHECK VALVE	2.000	PC																																																																						
VL1166A0	BB6-AR6 L FITTING	1.000	PC																																																																						
VL1174C0	D1.2 MM CALIBRATED D1.2 MM	1.000	PC																																																																						
VL1191A0	ONE WASHING DISTRIBUTOR OUTLETS KIT	1.000	PC																																																																						
VL1214A0	BAYONET - 6mm BARBED NRV VALVE	1.000	PC																																																																						
VM2172A0	LOCKING CLIP FOR PUMP WITH CIRCUIT	2.000	PC																																																																						
			KVL1166A	BB6-AR6 L FITTING 5 PCS KIT	<table border="1"> <thead> <tr> <th>Code</th> <th>Description</th> <th>Qty</th> <th>UOM</th> </tr> </thead> <tbody> <tr> <td>VL1166A0</td> <td>BB6-AR6 L FITTING</td> <td>5.000</td> <td>PC</td> </tr> </tbody> </table>	Code	Description	Qty	UOM	VL1166A0	BB6-AR6 L FITTING	5.000	PC																																																												
Code	Description	Qty	UOM																																																																						
VL1166A0	BB6-AR6 L FITTING	5.000	PC																																																																						







COMPONENT			SPARE PART																										
Code	Description	Image	Code	Description	Kit components																								
VM2172A	LOCKING CLIP FOR PUMP WITH CIRCUIT		VM2172A0	LOCKING CLIP FOR PUMP WITH CIRCUIT																									
0H2561A	6 S. DOOR COUNTERBRACKET		0H2561A0	6 S. DOOR COUNTERBRACKET																									
VI1995A	M5x25 ST. STEEL SCREW		VI1995A0	M5x25 ST. STEEL SCREW																									
VM1240A	NYLON SUPPORT CAP		KVM1240A	4 PCS COUNTER BRACKET SUPPORT CAP KIT	<table border="1"> <thead> <tr> <th>Code</th> <th>Description</th> <th>Qty</th> <th>UOM</th> </tr> </thead> <tbody> <tr> <td>VM1240A0</td> <td>NYLON SUPPORT CAP</td> <td>4.000</td> <td>PC</td> </tr> </tbody> </table>	Code	Description	Qty	UOM	VM1240A0	NYLON SUPPORT CAP	4.000	PC																
Code	Description	Qty	UOM																										
VM1240A0	NYLON SUPPORT CAP	4.000	PC																										
VM2273A	MM DOOR LEFT LOWER BRACKET		KVM2273A	MIND.Maps DOOR LOWER LEFT BRACKET KIT	<table border="1"> <thead> <tr> <th>Code</th> <th>Description</th> <th>Qty</th> <th>UOM</th> </tr> </thead> <tbody> <tr> <td>0H7330A0</td> <td>DOOR LOWER BRACKET WASHER</td> <td>2.000</td> <td>PC</td> </tr> <tr> <td>VI1995A0</td> <td>M5x25 ST. STEEL SCREW</td> <td>4.000</td> <td>PC</td> </tr> <tr> <td>VM2273A1</td> <td>MM DOOR LEFT LOWER BRACKET</td> <td>1.000</td> <td>PC</td> </tr> <tr> <td>VM2352A0</td> <td>MM LOWER DOOR BRACKET LEFT SCREW COVER</td> <td>1.000</td> <td>PC</td> </tr> <tr> <td>VM2353A0</td> <td>MM LOWER DOOR BRACKET RIGHT SCREW COVER</td> <td>1.000</td> <td>PC</td> </tr> </tbody> </table>	Code	Description	Qty	UOM	0H7330A0	DOOR LOWER BRACKET WASHER	2.000	PC	VI1995A0	M5x25 ST. STEEL SCREW	4.000	PC	VM2273A1	MM DOOR LEFT LOWER BRACKET	1.000	PC	VM2352A0	MM LOWER DOOR BRACKET LEFT SCREW COVER	1.000	PC	VM2353A0	MM LOWER DOOR BRACKET RIGHT SCREW COVER	1.000	PC
Code	Description	Qty	UOM																										
0H7330A0	DOOR LOWER BRACKET WASHER	2.000	PC																										
VI1995A0	M5x25 ST. STEEL SCREW	4.000	PC																										
VM2273A1	MM DOOR LEFT LOWER BRACKET	1.000	PC																										
VM2352A0	MM LOWER DOOR BRACKET LEFT SCREW COVER	1.000	PC																										
VM2353A0	MM LOWER DOOR BRACKET RIGHT SCREW COVER	1.000	PC																										





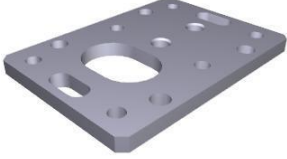

COMPONENT			SPARE PART										
Code	Description	Image	Code	Description	Kit components								
VM2352A	MM LOWER DOOR BRACKET LEFT SCREW COVERI		VM2352A0	MM LOWER DOOR BRACKET LEFT SCREW COVERI									
VM2353A	MM LOWER DOOR BRACKET RIGHT SCREW COVERI		VM2353A0	MM LOWER DOOR BRACKET RIGHT SCREW COVERI									
0H2561A	6 S. DOOR COUNTERBRACKET		0H2561A0	6 S. DOOR COUNTERBRACKET									
VI1995A	M5x25 ST.STEEL SCREW		VI1995A0	M5x25 ST.STEEL SCREW									
VM1240A	NYLON SUPPORT CAP		KVM1240A	4 PCS COUNTER BRACKET SUPPORT CAP KIT	<table border="1"> <thead> <tr> <th>Code</th> <th>Description</th> <th>Qty</th> <th>UOM</th> </tr> </thead> <tbody> <tr> <td>VM1240A0</td> <td>NYLON SUPPORT CAP</td> <td>4.000</td> <td>PC</td> </tr> </tbody> </table>	Code	Description	Qty	UOM	VM1240A0	NYLON SUPPORT CAP	4.000	PC
Code	Description	Qty	UOM										
VM1240A0	NYLON SUPPORT CAP	4.000	PC										



COMPONENT			SPARE PART																														
Code	Description	Image	Code	Description	Kit components																												
VM2271A	MM DOOR LEFT UPPER BRACKET		KVM2271A	MIND.MAPS UPPER LEFT DOOR BRACKET KIT	<table border="1"> <thead> <tr> <th>Code</th> <th>Description</th> <th>Qty</th> <th>UOM</th> </tr> </thead> <tbody> <tr> <td>VI1220A1</td> <td>4,2x12 TCB SELF-TAPPIN G SCREW</td> <td>2.000</td> <td>PC</td> </tr> <tr> <td>VI1995A0</td> <td>M5x25 ST.STEEL SCREW</td> <td>4.000</td> <td>PC</td> </tr> <tr> <td>VI1997A0</td> <td>5x10X1 FLAT WASHER</td> <td>4.000</td> <td>PC</td> </tr> <tr> <td>VM2271A0</td> <td>MM DOOR LEFT UPPER BRACKET</td> <td>1.000</td> <td>PC</td> </tr> <tr> <td>VM2298A0</td> <td>DOOR BRACKET UPPER COVER</td> <td>1.000</td> <td>PC</td> </tr> </tbody> </table>	Code	Description	Qty	UOM	VI1220A1	4,2x12 TCB SELF-TAPPIN G SCREW	2.000	PC	VI1995A0	M5x25 ST.STEEL SCREW	4.000	PC	VI1997A0	5x10X1 FLAT WASHER	4.000	PC	VM2271A0	MM DOOR LEFT UPPER BRACKET	1.000	PC	VM2298A0	DOOR BRACKET UPPER COVER	1.000	PC				
Code	Description	Qty	UOM																														
VI1220A1	4,2x12 TCB SELF-TAPPIN G SCREW	2.000	PC																														
VI1995A0	M5x25 ST.STEEL SCREW	4.000	PC																														
VI1997A0	5x10X1 FLAT WASHER	4.000	PC																														
VM2271A0	MM DOOR LEFT UPPER BRACKET	1.000	PC																														
VM2298A0	DOOR BRACKET UPPER COVER	1.000	PC																														
VM2298A	DOOR BRACKET UPPER COVER		KVM2298A	MIND.Maps DOOR UPPER BRACKET COVER KIT	<table border="1"> <thead> <tr> <th>Code</th> <th>Description</th> <th>Qty</th> <th>UOM</th> </tr> </thead> <tbody> <tr> <td>VI1220A1</td> <td>4,2x12 TCB SELF-TAPPIN G SCREW</td> <td>2.000</td> <td>PC</td> </tr> <tr> <td>VM2298A0</td> <td>DOOR BRACKET UPPER COVER</td> <td>1.000</td> <td>PC</td> </tr> </tbody> </table>	Code	Description	Qty	UOM	VI1220A1	4,2x12 TCB SELF-TAPPIN G SCREW	2.000	PC	VM2298A0	DOOR BRACKET UPPER COVER	1.000	PC																
Code	Description	Qty	UOM																														
VI1220A1	4,2x12 TCB SELF-TAPPIN G SCREW	2.000	PC																														
VM2298A0	DOOR BRACKET UPPER COVER	1.000	PC																														
0H2561A	6 S. DOOR COUNTERBRACKET		0H2561A0	6 S. DOOR COUNTERBRACKET																													
VE1020B	MAGNET DOOR MICROSWITCH		KVE1020B	MICROSWITCH KIT	<table border="1"> <thead> <tr> <th>Code</th> <th>Description</th> <th>Qty</th> <th>UOM</th> </tr> </thead> <tbody> <tr> <td>CE1030A0</td> <td>FEMALE FASTON COVER 6.3X0.8 0.5-1mmq</td> <td>2.000</td> <td>PC</td> </tr> <tr> <td>CE1660A0</td> <td>6,3x0,8 FEMALE FASTON COVE</td> <td>2.000</td> <td>PC</td> </tr> <tr> <td>CE1730A0</td> <td>PVC CABLE NP 2 X AWG22 STYLE 2095</td> <td>0.150</td> <td>M</td> </tr> <tr> <td>CE1740A0</td> <td>MINIFIT MALE END FITTING</td> <td>2.000</td> <td>PC</td> </tr> <tr> <td>CE1745A0</td> <td>2 WAYS FEMALE MINIFIT CONNECTOR</td> <td>1.000</td> <td>PC</td> </tr> <tr> <td>VE1020B0</td> <td>MAGNET DOOR MICROSWITC</td> <td>1.000</td> <td>PC</td> </tr> </tbody> </table>	Code	Description	Qty	UOM	CE1030A0	FEMALE FASTON COVER 6.3X0.8 0.5-1mmq	2.000	PC	CE1660A0	6,3x0,8 FEMALE FASTON COVE	2.000	PC	CE1730A0	PVC CABLE NP 2 X AWG22 STYLE 2095	0.150	M	CE1740A0	MINIFIT MALE END FITTING	2.000	PC	CE1745A0	2 WAYS FEMALE MINIFIT CONNECTOR	1.000	PC	VE1020B0	MAGNET DOOR MICROSWITC	1.000	PC
Code	Description	Qty	UOM																														
CE1030A0	FEMALE FASTON COVER 6.3X0.8 0.5-1mmq	2.000	PC																														
CE1660A0	6,3x0,8 FEMALE FASTON COVE	2.000	PC																														
CE1730A0	PVC CABLE NP 2 X AWG22 STYLE 2095	0.150	M																														
CE1740A0	MINIFIT MALE END FITTING	2.000	PC																														
CE1745A0	2 WAYS FEMALE MINIFIT CONNECTOR	1.000	PC																														
VE1020B0	MAGNET DOOR MICROSWITC	1.000	PC																														

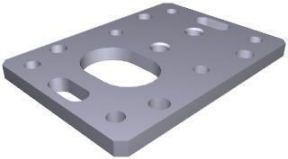

COMPONENT			SPARE PART														
Code	Description	Image	Code	Description	Kit components												
VE1020B	MAGNET DOOR MICROSWITCH		KVE1020B	MICROSWITCH KIT	<table border="1"> <thead> <tr> <th>Code</th> <th>Description</th> <th>Qty</th> <th>UOM</th> </tr> </thead> <tbody> <tr> <td>VE1030A1</td> <td>MAGNET FOR DOOR MICROSWITC H D=22.9mm</td> <td>1.000</td> <td>PC</td> </tr> <tr> <td>V1192A0</td> <td></td> <td>1.000</td> <td>PC</td> </tr> </tbody> </table>	Code	Description	Qty	UOM	VE1030A1	MAGNET FOR DOOR MICROSWITC H D=22.9mm	1.000	PC	V1192A0		1.000	PC
Code	Description	Qty	UOM														
VE1030A1	MAGNET FOR DOOR MICROSWITC H D=22.9mm	1.000	PC														
V1192A0		1.000	PC														
VM1240A	NYLON SUPPORT CAP		KVM1240A	4 PCS COUNTER BRACKET SUPPORT CAP KIT	<table border="1"> <thead> <tr> <th>Code</th> <th>Description</th> <th>Qty</th> <th>UOM</th> </tr> </thead> <tbody> <tr> <td>VM1240A0</td> <td>NYLON SUPPORT CAP</td> <td>4.000</td> <td>PC</td> </tr> </tbody> </table>	Code	Description	Qty	UOM	VM1240A0	NYLON SUPPORT CAP	4.000	PC				
Code	Description	Qty	UOM														
VM1240A0	NYLON SUPPORT CAP	4.000	PC														
VP1075A	PLUS/1/ZERO MICROSWITCH SUPPORT COVER		KVP1075A	-M MICROSWITCH SUPPORT PLATE KI	<table border="1"> <thead> <tr> <th>Code</th> <th>Description</th> <th>Qty</th> <th>UOM</th> </tr> </thead> <tbody> <tr> <td>VP1075A0</td> <td>PLUS/1/ZERO MICROSWITC H SUPPORT COVER</td> <td>1.000</td> <td>PC</td> </tr> </tbody> </table>	Code	Description	Qty	UOM	VP1075A0	PLUS/1/ZERO MICROSWITC H SUPPORT COVER	1.000	PC				
Code	Description	Qty	UOM														
VP1075A0	PLUS/1/ZERO MICROSWITC H SUPPORT COVER	1.000	PC														
0H2561A	6 S. DOOR COUNTERBRACKET		0H2561A0	6 S. DOOR COUNTERBRACKET													
VM1240A	NYLON SUPPORT CAP		KVM1240A	4 PCS COUNTER BRACKET SUPPORT CAP KIT	<table border="1"> <thead> <tr> <th>Code</th> <th>Description</th> <th>Qty</th> <th>UOM</th> </tr> </thead> <tbody> <tr> <td>VM1240A0</td> <td>NYLON SUPPORT CAP</td> <td>4.000</td> <td>PC</td> </tr> </tbody> </table>	Code	Description	Qty	UOM	VM1240A0	NYLON SUPPORT CAP	4.000	PC				
Code	Description	Qty	UOM														
VM1240A0	NYLON SUPPORT CAP	4.000	PC														

COMPONENT			SPARE PART																										
Code	Description	Image	Code	Description	Kit components																								
VM2310A	UPPER DOOR BRACKET HOLES COVER		KVM2310A	UPPER BRACKET HOLE COVER KIT	<table border="1"> <thead> <tr> <th>Code</th> <th>Description</th> <th>Qty</th> <th>UOM</th> </tr> </thead> <tbody> <tr> <td>VM2310A0</td> <td>UPPER DOOR BRACKET HOLES COVER</td> <td>1.000</td> <td>PC</td> </tr> </tbody> </table>	Code	Description	Qty	UOM	VM2310A0	UPPER DOOR BRACKET HOLES COVER	1.000	PC																
Code	Description	Qty	UOM																										
VM2310A0	UPPER DOOR BRACKET HOLES COVER	1.000	PC																										
PD1074A	H=100 SQUARE FOOT		KPD1074A	Mind.Maps H100 FOOT KIT	<table border="1"> <thead> <tr> <th>Code</th> <th>Description</th> <th>Qty</th> <th>UOM</th> </tr> </thead> <tbody> <tr> <td>PD1074A0</td> <td>H=100 SQUARE FOOT</td> <td>1.000</td> <td>PC</td> </tr> <tr> <td>PD1075A1</td> <td>PD1074 FOOT LOCKING BRACKET</td> <td>1.000</td> <td>PC</td> </tr> <tr> <td>VI1220A1</td> <td>4,2x12 TCB SELF-TAPPIN G SCREW</td> <td>5.000</td> <td>PC</td> </tr> </tbody> </table>	Code	Description	Qty	UOM	PD1074A0	H=100 SQUARE FOOT	1.000	PC	PD1075A1	PD1074 FOOT LOCKING BRACKET	1.000	PC	VI1220A1	4,2x12 TCB SELF-TAPPIN G SCREW	5.000	PC								
Code	Description	Qty	UOM																										
PD1074A0	H=100 SQUARE FOOT	1.000	PC																										
PD1075A1	PD1074 FOOT LOCKING BRACKET	1.000	PC																										
VI1220A1	4,2x12 TCB SELF-TAPPIN G SCREW	5.000	PC																										
PD1075A	PD1074 FOOT LOCKING BRACKET		KPD1075A	OVEN FOOT STOPPING BRACKET 4 PCS KIT	<table border="1"> <thead> <tr> <th>Code</th> <th>Description</th> <th>Qty</th> <th>UOM</th> </tr> </thead> <tbody> <tr> <td>PD1075A1</td> <td>PD1074 FOOT LOCKING BRACKET</td> <td>4.000</td> <td>PC</td> </tr> <tr> <td>VI1950A0</td> <td>ST. STEEL 4,2X13 TCB SELF-DRILLIN G SCREW</td> <td>8.000</td> <td>PC</td> </tr> </tbody> </table>	Code	Description	Qty	UOM	PD1075A1	PD1074 FOOT LOCKING BRACKET	4.000	PC	VI1950A0	ST. STEEL 4,2X13 TCB SELF-DRILLIN G SCREW	8.000	PC												
Code	Description	Qty	UOM																										
PD1075A1	PD1074 FOOT LOCKING BRACKET	4.000	PC																										
VI1950A0	ST. STEEL 4,2X13 TCB SELF-DRILLIN G SCREW	8.000	PC																										
TR1162A	335°C UNIPOLAR SAFETY THERMOSTAT		KTR1136A	318°C -0/+24 SAFETY THERMOSTAT KIT	<table border="1"> <thead> <tr> <th>Code</th> <th>Description</th> <th>Qty</th> <th>UOM</th> </tr> </thead> <tbody> <tr> <td>0H7030A0</td> <td>THERMOSTAT BULB INLET COVER</td> <td>1.000</td> <td>PC</td> </tr> <tr> <td>GN1531A0</td> <td>THERMOSTAT BULB INLET SEALING</td> <td>1.000</td> <td>PC</td> </tr> <tr> <td>SL1045A0</td> <td>S57 BLACK SILICONE - 80ml CARTRIDGE</td> <td>1.000</td> <td>PC</td> </tr> <tr> <td>TR1136A0</td> <td>318°C -0/+24 1 POLE SAFETY THERMOSTAT</td> <td>1.000</td> <td>PC</td> </tr> <tr> <td>VI1220A1</td> <td>4,2x12 TCB SELF-TAPPIN G SCREW</td> <td>3.000</td> <td>PC</td> </tr> </tbody> </table>	Code	Description	Qty	UOM	0H7030A0	THERMOSTAT BULB INLET COVER	1.000	PC	GN1531A0	THERMOSTAT BULB INLET SEALING	1.000	PC	SL1045A0	S57 BLACK SILICONE - 80ml CARTRIDGE	1.000	PC	TR1136A0	318°C -0/+24 1 POLE SAFETY THERMOSTAT	1.000	PC	VI1220A1	4,2x12 TCB SELF-TAPPIN G SCREW	3.000	PC
Code	Description	Qty	UOM																										
0H7030A0	THERMOSTAT BULB INLET COVER	1.000	PC																										
GN1531A0	THERMOSTAT BULB INLET SEALING	1.000	PC																										
SL1045A0	S57 BLACK SILICONE - 80ml CARTRIDGE	1.000	PC																										
TR1136A0	318°C -0/+24 1 POLE SAFETY THERMOSTAT	1.000	PC																										
VI1220A1	4,2x12 TCB SELF-TAPPIN G SCREW	3.000	PC																										



COMPONENT			SPARE PART																						
Code	Description	Image	Code	Description	Kit components																				
VM1992A	E SERIES BAKERTOP DRIP TRAY		KVM1992A	E SERIES BAKERTOP DRIP TRAY	<table border="1"> <thead> <tr> <th>Code</th> <th>Description</th> <th>Qty</th> <th>UOM</th> </tr> </thead> <tbody> <tr> <td>VM1220A0</td> <td>CLIP TO FIX DRIP TRAY C.T</td> <td>4.000</td> <td>PC</td> </tr> <tr> <td>VM1992A0</td> <td>E SERIES BAKERTOP DRIP TRAY</td> <td>1.000</td> <td>PC</td> </tr> <tr> <td>VM2074A1</td> <td>DRAWER SUPPORT SCREW WITH CLIP</td> <td>4.000</td> <td>PC</td> </tr> </tbody> </table>	Code	Description	Qty	UOM	VM1220A0	CLIP TO FIX DRIP TRAY C.T	4.000	PC	VM1992A0	E SERIES BAKERTOP DRIP TRAY	1.000	PC	VM2074A1	DRAWER SUPPORT SCREW WITH CLIP	4.000	PC				
Code	Description	Qty	UOM																						
VM1220A0	CLIP TO FIX DRIP TRAY C.T	4.000	PC																						
VM1992A0	E SERIES BAKERTOP DRIP TRAY	1.000	PC																						
VM2074A1	DRAWER SUPPORT SCREW WITH CLIP	4.000	PC																						
VM2035A	DRAIN PIPE SUPPORT		KVM2035A	DRAIN PIPE SUPPORT 2 PCS. KI	<table border="1"> <thead> <tr> <th>Code</th> <th>Description</th> <th>Qty</th> <th>UOM</th> </tr> </thead> <tbody> <tr> <td>VM2035A0</td> <td>DRAIN PIPE SUPPORT</td> <td>2.000</td> <td>PC</td> </tr> </tbody> </table>	Code	Description	Qty	UOM	VM2035A0	DRAIN PIPE SUPPORT	2.000	PC												
Code	Description	Qty	UOM																						
VM2035A0	DRAIN PIPE SUPPORT	2.000	PC																						
VM2061A	ACCESSORIES CABLES WALL PASSING		KVM1505A	THROUGH-WALL CONNECTION+DIAP HRAGM KIT	<table border="1"> <thead> <tr> <th>Code</th> <th>Description</th> <th>Qty</th> <th>UOM</th> </tr> </thead> <tbody> <tr> <td>VI1220A1</td> <td>4,2x12 TCB SELF-TAPPIN G SCREW</td> <td>1.000</td> <td>PC</td> </tr> <tr> <td>VM1505A0</td> <td>WALL PASSING WITH DIAPHRAGM</td> <td>3.000</td> <td>PC</td> </tr> <tr> <td>VM2055A0</td> <td>UPPER WALL PASSING ACCESSORY CABLES</td> <td>1.000</td> <td>PC</td> </tr> <tr> <td>VM2056A0</td> <td>LOWER WALL PASSING ACCESSORY CABLES</td> <td>1.000</td> <td>PC</td> </tr> </tbody> </table>	Code	Description	Qty	UOM	VI1220A1	4,2x12 TCB SELF-TAPPIN G SCREW	1.000	PC	VM1505A0	WALL PASSING WITH DIAPHRAGM	3.000	PC	VM2055A0	UPPER WALL PASSING ACCESSORY CABLES	1.000	PC	VM2056A0	LOWER WALL PASSING ACCESSORY CABLES	1.000	PC
Code	Description	Qty	UOM																						
VI1220A1	4,2x12 TCB SELF-TAPPIN G SCREW	1.000	PC																						
VM1505A0	WALL PASSING WITH DIAPHRAGM	3.000	PC																						
VM2055A0	UPPER WALL PASSING ACCESSORY CABLES	1.000	PC																						
VM2056A0	LOWER WALL PASSING ACCESSORY CABLES	1.000	PC																						
VM2074A	DRAWER SUPPORT SCREW WITH CLIP		KVM1220A	CT/BT DRIP TRAY FIXING CLIPS 4PCS KIT	<table border="1"> <thead> <tr> <th>Code</th> <th>Description</th> <th>Qty</th> <th>UOM</th> </tr> </thead> <tbody> <tr> <td>VI1220A1</td> <td>4,2x12 TCB SELF-TAPPIN G SCREW</td> <td>4.000</td> <td>PC</td> </tr> <tr> <td>VM1220A0</td> <td>CLIP TO FIX DRIP TRAY C.T</td> <td>4.000</td> <td>PC</td> </tr> <tr> <td>VM2074A1</td> <td>DRAWER SUPPORT SCREW WITH CLIP</td> <td>4.000</td> <td>PC</td> </tr> </tbody> </table>	Code	Description	Qty	UOM	VI1220A1	4,2x12 TCB SELF-TAPPIN G SCREW	4.000	PC	VM1220A0	CLIP TO FIX DRIP TRAY C.T	4.000	PC	VM2074A1	DRAWER SUPPORT SCREW WITH CLIP	4.000	PC				
Code	Description	Qty	UOM																						
VI1220A1	4,2x12 TCB SELF-TAPPIN G SCREW	4.000	PC																						
VM1220A0	CLIP TO FIX DRIP TRAY C.T	4.000	PC																						
VM2074A1	DRAWER SUPPORT SCREW WITH CLIP	4.000	PC																						



COMPONENT			SPARE PART														
Code	Description	Image	Code	Description	Kit components												
VM2249A	COOKING CHAMBER FRONT CORNER		KVM2249A	CHAMBER FRONT PROFILE CORNER KIT	<table border="1"> <thead> <tr> <th>Code</th> <th>Description</th> <th>Qty</th> <th>UOM</th> </tr> </thead> <tbody> <tr> <td>VM2249A0</td> <td>COOKING CHAMBER FRONT CORNER</td> <td>1.000</td> <td>PC</td> </tr> </tbody> </table>	Code	Description	Qty	UOM	VM2249A0	COOKING CHAMBER FRONT CORNER	1.000	PC				
Code	Description	Qty	UOM														
VM2249A0	COOKING CHAMBER FRONT CORNER	1.000	PC														
VM2311A	SCREWS COVER		KVM2311A	SCREWS COVER PLATE KIT	<table border="1"> <thead> <tr> <th>Code</th> <th>Description</th> <th>Qty</th> <th>UOM</th> </tr> </thead> <tbody> <tr> <td>VM2311A0</td> <td>SCREWS COVER</td> <td>1.000</td> <td>PC</td> </tr> </tbody> </table>	Code	Description	Qty	UOM	VM2311A0	SCREWS COVER	1.000	PC				
Code	Description	Qty	UOM														
VM2311A0	SCREWS COVER	1.000	PC														
VM2450A	THROUGH-WALL CONNECTION 3 PIPES		KVM2450A	3 PIPES THROUGH-WALL CONNECTION KIT	<table border="1"> <thead> <tr> <th>Code</th> <th>Description</th> <th>Qty</th> <th>UOM</th> </tr> </thead> <tbody> <tr> <td>VM2450A0</td> <td>THROUGH-WALL CONNECTION 3 PIPES</td> <td>1.000</td> <td>PC</td> </tr> </tbody> </table>	Code	Description	Qty	UOM	VM2450A0	THROUGH-WALL CONNECTION 3 PIPES	1.000	PC				
Code	Description	Qty	UOM														
VM2450A0	THROUGH-WALL CONNECTION 3 PIPES	1.000	PC														
VP1121A	LEFT-RIGHT WATER SEALING CAP		VP1121A0	LEFT-RIGHT WATER SEALING CAP													
VP1168A	CHIMNEY SEALING RING		KVP1168A	CHIMNEY SEALING RING KIT	<table border="1"> <thead> <tr> <th>Code</th> <th>Description</th> <th>Qty</th> <th>UOM</th> </tr> </thead> <tbody> <tr> <td>V11220A1</td> <td>4,2x12 TCB SELF-TAPPING SCREW</td> <td>3.000</td> <td>PC</td> </tr> <tr> <td>VP1168A0</td> <td>CHIMNEY SEALING RING</td> <td>1.000</td> <td>PC</td> </tr> </tbody> </table>	Code	Description	Qty	UOM	V11220A1	4,2x12 TCB SELF-TAPPING SCREW	3.000	PC	VP1168A0	CHIMNEY SEALING RING	1.000	PC
Code	Description	Qty	UOM														
V11220A1	4,2x12 TCB SELF-TAPPING SCREW	3.000	PC														
VP1168A0	CHIMNEY SEALING RING	1.000	PC														



ASM3006B/0.D03 - Door - FRONT





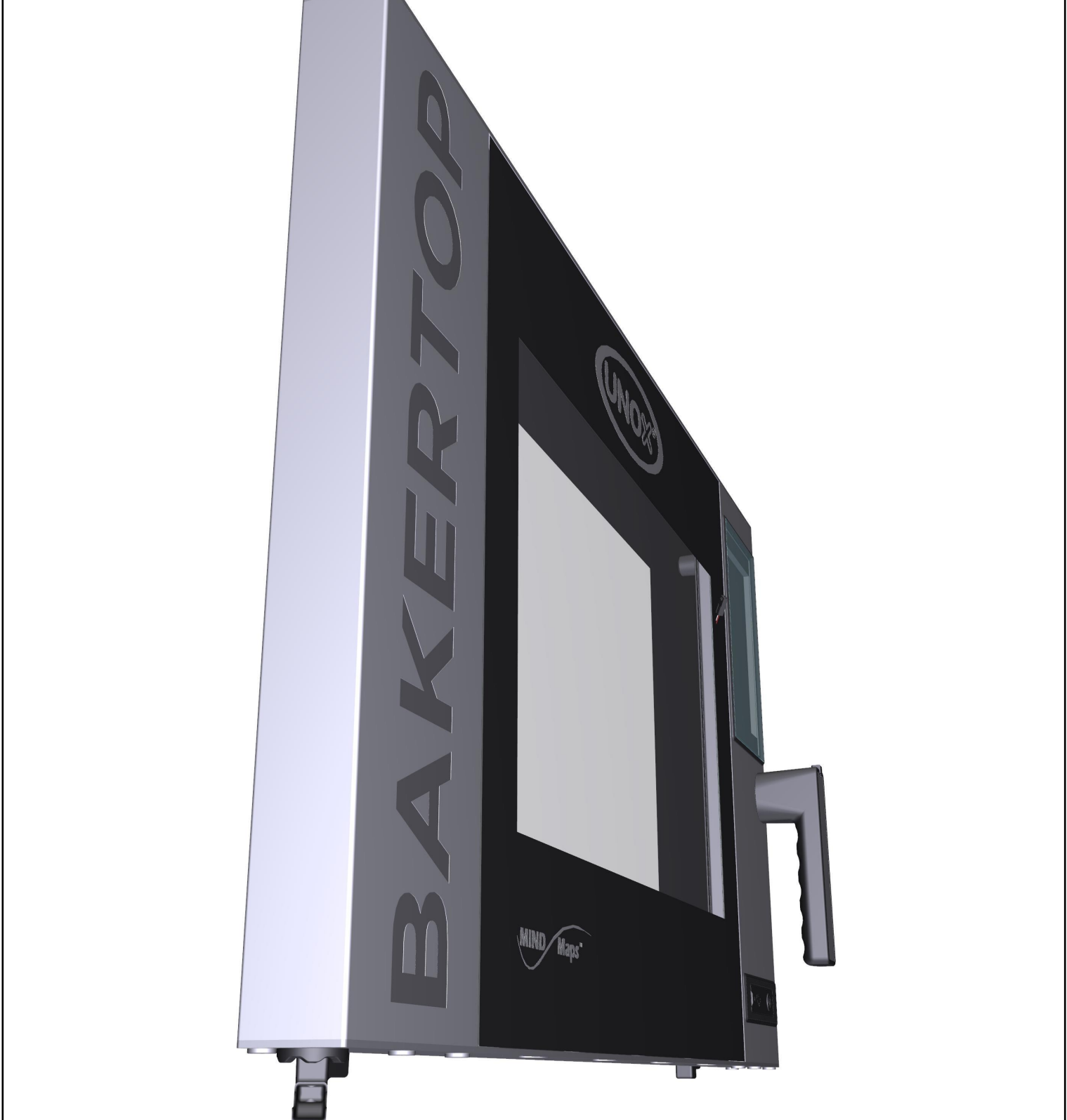

ASM3006B/0.D03 - Door - REAR





COMPONENT			SPARE PART																																																																		
Code	Description	Image	Code	Description	Kit components																																																																
OB1107A	XEVC-0511-E LEFT INT DOOR COLUMN		KDR1325A	0511 ZERO RIGHT -M EXTERNAL DOOR	<table border="1"> <thead> <tr> <th>Code</th> <th>Description</th> <th>Qty</th> <th>UOM</th> </tr> </thead> <tbody> <tr> <td>OB1106A0</td> <td>XEVC-0511-E DOOR EXTERNAL LEFT COLUMN</td> <td>1.000</td> <td>PC</td> </tr> <tr> <td>OB1107A1</td> <td>XEVC-0511-E LEFT INT DOOR COLUM</td> <td>1.000</td> <td>PC</td> </tr> <tr> <td>OB1108B1</td> <td>XEVC-0511 DOOR EXTERNAL RIGHT COLUM</td> <td>1.000</td> <td>PC</td> </tr> <tr> <td>OB1109A1</td> <td>XEVC-0511-E RIGHT INT DOOR COLUM</td> <td>1.000</td> <td>PC</td> </tr> <tr> <td>OB1122B0</td> <td>MM CT 750mm DOOR LOWER BEAM</td> <td>1.000</td> <td>PC</td> </tr> <tr> <td>OB1166A1</td> <td>XEVC-0511-E EXT GLASS SUPPORT PROFILE</td> <td>2.000</td> <td>PC</td> </tr> <tr> <td>OB1216B0</td> <td>MM DOUBLE GLASS DOOR 750mm UPPER BEAM</td> <td>1.000</td> <td>PC</td> </tr> <tr> <td>OB1217A1</td> <td>MM DOUBLE GLASS DOOR INT UPPER BEAM 750</td> <td>1.000</td> <td>PC</td> </tr> <tr> <td>0H2892A0</td> <td>LED BAR UPPER CAP PLATE</td> <td>1.000</td> <td>PC</td> </tr> <tr> <td>0H2893A0</td> <td>LED BAR LOWER CAP PLATE</td> <td>1.000</td> <td>PC</td> </tr> <tr> <td>CE1096A0</td> <td>4 POLES MICROFIT 3 M BUS CABLE</td> <td>1.000</td> <td>PC</td> </tr> <tr> <td>CE1285A0</td> <td>EMI ROUND FERRITE MOD.26438015 02</td> <td>2.000</td> <td>PC</td> </tr> <tr> <td>CE1851A0</td> <td>MICROFIT CABLE 2P M-F-F AWG22</td> <td>1.000</td> <td>PC</td> </tr> <tr> <td>CE2001A0</td> <td>MICROFIT CABLE 2PM-100-2PM 2AWG22</td> <td>1.000</td> <td>PC</td> </tr> <tr> <td>CE2002A0</td> <td>MICROFIT CABLE 2PM-100-AMP MODU2 2AWG22</td> <td>1.000</td> <td>PC</td> </tr> </tbody> </table>	Code	Description	Qty	UOM	OB1106A0	XEVC-0511-E DOOR EXTERNAL LEFT COLUMN	1.000	PC	OB1107A1	XEVC-0511-E LEFT INT DOOR COLUM	1.000	PC	OB1108B1	XEVC-0511 DOOR EXTERNAL RIGHT COLUM	1.000	PC	OB1109A1	XEVC-0511-E RIGHT INT DOOR COLUM	1.000	PC	OB1122B0	MM CT 750mm DOOR LOWER BEAM	1.000	PC	OB1166A1	XEVC-0511-E EXT GLASS SUPPORT PROFILE	2.000	PC	OB1216B0	MM DOUBLE GLASS DOOR 750mm UPPER BEAM	1.000	PC	OB1217A1	MM DOUBLE GLASS DOOR INT UPPER BEAM 750	1.000	PC	0H2892A0	LED BAR UPPER CAP PLATE	1.000	PC	0H2893A0	LED BAR LOWER CAP PLATE	1.000	PC	CE1096A0	4 POLES MICROFIT 3 M BUS CABLE	1.000	PC	CE1285A0	EMI ROUND FERRITE MOD.26438015 02	2.000	PC	CE1851A0	MICROFIT CABLE 2P M-F-F AWG22	1.000	PC	CE2001A0	MICROFIT CABLE 2PM-100-2PM 2AWG22	1.000	PC	CE2002A0	MICROFIT CABLE 2PM-100-AMP MODU2 2AWG22	1.000	PC
					Code	Description	Qty	UOM																																																													
					OB1106A0	XEVC-0511-E DOOR EXTERNAL LEFT COLUMN	1.000	PC																																																													
					OB1107A1	XEVC-0511-E LEFT INT DOOR COLUM	1.000	PC																																																													
					OB1108B1	XEVC-0511 DOOR EXTERNAL RIGHT COLUM	1.000	PC																																																													
					OB1109A1	XEVC-0511-E RIGHT INT DOOR COLUM	1.000	PC																																																													
					OB1122B0	MM CT 750mm DOOR LOWER BEAM	1.000	PC																																																													
					OB1166A1	XEVC-0511-E EXT GLASS SUPPORT PROFILE	2.000	PC																																																													
					OB1216B0	MM DOUBLE GLASS DOOR 750mm UPPER BEAM	1.000	PC																																																													
					OB1217A1	MM DOUBLE GLASS DOOR INT UPPER BEAM 750	1.000	PC																																																													
					0H2892A0	LED BAR UPPER CAP PLATE	1.000	PC																																																													
					0H2893A0	LED BAR LOWER CAP PLATE	1.000	PC																																																													
					CE1096A0	4 POLES MICROFIT 3 M BUS CABLE	1.000	PC																																																													
					CE1285A0	EMI ROUND FERRITE MOD.26438015 02	2.000	PC																																																													
					CE1851A0	MICROFIT CABLE 2P M-F-F AWG22	1.000	PC																																																													
CE2001A0	MICROFIT CABLE 2PM-100-2PM 2AWG22	1.000	PC																																																																		
CE2002A0	MICROFIT CABLE 2PM-100-AMP MODU2 2AWG22	1.000	PC																																																																		



COMPONENT			SPARE PART																																																																						
Code	Description	Image	Code	Description	Kit components																																																																				
OB1107A	XEVC-0511-E LEFT INT DOOR COLUMN		KDR1325A	0511 ZERO RIGHT -M EXTERNAL DOOR	<table border="1"> <thead> <tr> <th>Code</th> <th>Description</th> <th>Qty</th> <th>UOM</th> </tr> </thead> <tbody> <tr> <td>GN1525A0</td> <td>O-RING INT DIAM 9,5 THK 1 NBR 70</td> <td>1.000</td> <td>PC</td> </tr> <tr> <td>LP1019A0</td> <td>6 SERIES L200 LED LIGHT BAR - E415</td> <td>1.000</td> <td>PC</td> </tr> <tr> <td>MG1099A1</td> <td>MM COMPLETE HANDLE</td> <td>1.000</td> <td>PC</td> </tr> <tr> <td>RC1200A0</td> <td>ED=4 WIRE D=0.5 H24 COMPRESSIO N SPRING</td> <td>4.000</td> <td>PC</td> </tr> <tr> <td>SL1170A1</td> <td>S57 BLACK SILICON - 310ml CARTRIDGE</td> <td>30.000</td> <td>ML</td> </tr> <tr> <td>SL1221A0</td> <td>GN1/1 EXTERNAL GLASS UPPER SILICONE</td> <td>1.000</td> <td>PC</td> </tr> <tr> <td>SL1222A0</td> <td>0511 EXTERNAL GLASS LATERAL SILICONE</td> <td>4.000</td> <td>PC</td> </tr> <tr> <td>VE1030A1</td> <td>MAGNET FOR DOOR MICROSWITC H D=22,9mm</td> <td>1.000</td> <td>PC</td> </tr> <tr> <td>VI0239A1</td> <td>SELF-TAPPIN G SCREW 4.2X25 TCB+ INOX</td> <td>4.000</td> <td>PC</td> </tr> <tr> <td>VI1034A0</td> <td>STAINLESS STEEL WASHER 8.4x16x1</td> <td>1.000</td> <td>PC</td> </tr> <tr> <td>VI1074A0</td> <td>4X16 SCREW FOR PLASTIC</td> <td>2.000</td> <td>PC</td> </tr> <tr> <td>VI1103A0</td> <td>40X12 TBSP SCREW FOR PLASTIC</td> <td>2.000</td> <td>PC</td> </tr> <tr> <td>VI1220A1</td> <td>4,2x12 TCB SELF-TAPPIN G SCREW</td> <td>26.000</td> <td>PC</td> </tr> <tr> <td>VI1930A1</td> <td>5x20 ST. STEEL CHIP SCREW</td> <td>16.000</td> <td>PC</td> </tr> <tr> <td>VI1996A0</td> <td>M5x35 SCREW</td> <td>13.000</td> <td>PC</td> </tr> <tr> <td>VI2070A0</td> <td>SHEETTRACS TCB+ 40x8 SELF-THREAD SCREW</td> <td>6.000</td> <td>PC</td> </tr> </tbody> </table>	Code	Description	Qty	UOM	GN1525A0	O-RING INT DIAM 9,5 THK 1 NBR 70	1.000	PC	LP1019A0	6 SERIES L200 LED LIGHT BAR - E415	1.000	PC	MG1099A1	MM COMPLETE HANDLE	1.000	PC	RC1200A0	ED=4 WIRE D=0.5 H24 COMPRESSIO N SPRING	4.000	PC	SL1170A1	S57 BLACK SILICON - 310ml CARTRIDGE	30.000	ML	SL1221A0	GN1/1 EXTERNAL GLASS UPPER SILICONE	1.000	PC	SL1222A0	0511 EXTERNAL GLASS LATERAL SILICONE	4.000	PC	VE1030A1	MAGNET FOR DOOR MICROSWITC H D=22,9mm	1.000	PC	VI0239A1	SELF-TAPPIN G SCREW 4.2X25 TCB+ INOX	4.000	PC	VI1034A0	STAINLESS STEEL WASHER 8.4x16x1	1.000	PC	VI1074A0	4X16 SCREW FOR PLASTIC	2.000	PC	VI1103A0	40X12 TBSP SCREW FOR PLASTIC	2.000	PC	VI1220A1	4,2x12 TCB SELF-TAPPIN G SCREW	26.000	PC	VI1930A1	5x20 ST. STEEL CHIP SCREW	16.000	PC	VI1996A0	M5x35 SCREW	13.000	PC	VI2070A0	SHEETTRACS TCB+ 40x8 SELF-THREAD SCREW	6.000	PC
					Code	Description	Qty	UOM																																																																	
					GN1525A0	O-RING INT DIAM 9,5 THK 1 NBR 70	1.000	PC																																																																	
					LP1019A0	6 SERIES L200 LED LIGHT BAR - E415	1.000	PC																																																																	
					MG1099A1	MM COMPLETE HANDLE	1.000	PC																																																																	
					RC1200A0	ED=4 WIRE D=0.5 H24 COMPRESSIO N SPRING	4.000	PC																																																																	
					SL1170A1	S57 BLACK SILICON - 310ml CARTRIDGE	30.000	ML																																																																	
					SL1221A0	GN1/1 EXTERNAL GLASS UPPER SILICONE	1.000	PC																																																																	
					SL1222A0	0511 EXTERNAL GLASS LATERAL SILICONE	4.000	PC																																																																	
					VE1030A1	MAGNET FOR DOOR MICROSWITC H D=22,9mm	1.000	PC																																																																	
					VI0239A1	SELF-TAPPIN G SCREW 4.2X25 TCB+ INOX	4.000	PC																																																																	
					VI1034A0	STAINLESS STEEL WASHER 8.4x16x1	1.000	PC																																																																	
					VI1074A0	4X16 SCREW FOR PLASTIC	2.000	PC																																																																	
					VI1103A0	40X12 TBSP SCREW FOR PLASTIC	2.000	PC																																																																	
					VI1220A1	4,2x12 TCB SELF-TAPPIN G SCREW	26.000	PC																																																																	
VI1930A1	5x20 ST. STEEL CHIP SCREW	16.000	PC																																																																						
VI1996A0	M5x35 SCREW	13.000	PC																																																																						
VI2070A0	SHEETTRACS TCB+ 40x8 SELF-THREAD SCREW	6.000	PC																																																																						



COMPONENT			SPARE PART																																																																														
Code	Description	Image	Code	Description	Kit components																																																																												
OB1107A	XEVC-0511-E LEFT INT DOOR COLUMN		KDR1325A	0511 ZERO RIGHT -M EXTERNAL DOOR	<table border="1"> <thead> <tr> <th>Code</th> <th>Description</th> <th>Qty</th> <th>UOM</th> </tr> </thead> <tbody> <tr> <td>VM1490A0</td> <td>CHEFTOP/BAK ERTOP HANDLE SCREWS COVER</td> <td>2.000</td> <td>PC</td> </tr> <tr> <td>VM1630A1</td> <td>INTERNAL GLASS PUSHING CAP</td> <td>3.000</td> <td>PC</td> </tr> <tr> <td>VM1631A0</td> <td>PLUS INNER GLASS PUSHING CAP</td> <td>3.000</td> <td>PC</td> </tr> <tr> <td>VM2259B0</td> <td>VM2259B0</td> <td>1.000</td> <td>PC</td> </tr> <tr> <td>VM2260B0</td> <td>S6 LEFT UPPER CAP</td> <td>1.000</td> <td>PC</td> </tr> <tr> <td>VM2261B0</td> <td>MM -M DOOR RIGHT LOWER CAP</td> <td>1.000</td> <td>PC</td> </tr> <tr> <td>VM2262B0</td> <td>MM -M DOOR RIGHT UPPER CAP</td> <td>1.000</td> <td>PC</td> </tr> <tr> <td>VM2267A0</td> <td>INTERNAL GLASS LOCKING SYSTEM SLIDER</td> <td>2.000</td> <td>PC</td> </tr> <tr> <td>VM2268A0</td> <td>DOOR MAGNET COVER</td> <td>2.000</td> <td>PC</td> </tr> <tr> <td>VM2269B0</td> <td>INNER GLASS FIXING CAP</td> <td>2.000</td> <td>PC</td> </tr> <tr> <td>VM2274A0</td> <td>GROOVED BUSHING</td> <td>1.000</td> <td>PC</td> </tr> <tr> <td>VM2275A0</td> <td>SMOOTH BUSHING</td> <td>1.000</td> <td>PC</td> </tr> <tr> <td>VM2284B0</td> <td>750 SERIES DRIP PROFILE KIT</td> <td>1.000</td> <td>PC</td> </tr> <tr> <td>VM2305A0</td> <td>MM SERIES DOOR CAP FIXING PAWL</td> <td>14.000</td> <td>PC</td> </tr> <tr> <td>VM2312A0</td> <td>MM DRIP PROFILE DRAIN LEFT PIPE</td> <td>1.000</td> <td>PC</td> </tr> <tr> <td>VM2314A0</td> <td>MM DRIP PROFILE CAP</td> <td>1.000</td> <td>PC</td> </tr> <tr> <td>VM2315B0</td> <td>S6 INTERNAL GLASS SUPPORT</td> <td>3.000</td> <td>PC</td> </tr> <tr> <td>VM2505B1</td> <td>MM PLUS INTERNAL GLASS SUPPORT</td> <td>3.000</td> <td>PC</td> </tr> </tbody> </table>	Code	Description	Qty	UOM	VM1490A0	CHEFTOP/BAK ERTOP HANDLE SCREWS COVER	2.000	PC	VM1630A1	INTERNAL GLASS PUSHING CAP	3.000	PC	VM1631A0	PLUS INNER GLASS PUSHING CAP	3.000	PC	VM2259B0	VM2259B0	1.000	PC	VM2260B0	S6 LEFT UPPER CAP	1.000	PC	VM2261B0	MM -M DOOR RIGHT LOWER CAP	1.000	PC	VM2262B0	MM -M DOOR RIGHT UPPER CAP	1.000	PC	VM2267A0	INTERNAL GLASS LOCKING SYSTEM SLIDER	2.000	PC	VM2268A0	DOOR MAGNET COVER	2.000	PC	VM2269B0	INNER GLASS FIXING CAP	2.000	PC	VM2274A0	GROOVED BUSHING	1.000	PC	VM2275A0	SMOOTH BUSHING	1.000	PC	VM2284B0	750 SERIES DRIP PROFILE KIT	1.000	PC	VM2305A0	MM SERIES DOOR CAP FIXING PAWL	14.000	PC	VM2312A0	MM DRIP PROFILE DRAIN LEFT PIPE	1.000	PC	VM2314A0	MM DRIP PROFILE CAP	1.000	PC	VM2315B0	S6 INTERNAL GLASS SUPPORT	3.000	PC	VM2505B1	MM PLUS INTERNAL GLASS SUPPORT	3.000	PC
Code	Description	Qty	UOM																																																																														
VM1490A0	CHEFTOP/BAK ERTOP HANDLE SCREWS COVER	2.000	PC																																																																														
VM1630A1	INTERNAL GLASS PUSHING CAP	3.000	PC																																																																														
VM1631A0	PLUS INNER GLASS PUSHING CAP	3.000	PC																																																																														
VM2259B0	VM2259B0	1.000	PC																																																																														
VM2260B0	S6 LEFT UPPER CAP	1.000	PC																																																																														
VM2261B0	MM -M DOOR RIGHT LOWER CAP	1.000	PC																																																																														
VM2262B0	MM -M DOOR RIGHT UPPER CAP	1.000	PC																																																																														
VM2267A0	INTERNAL GLASS LOCKING SYSTEM SLIDER	2.000	PC																																																																														
VM2268A0	DOOR MAGNET COVER	2.000	PC																																																																														
VM2269B0	INNER GLASS FIXING CAP	2.000	PC																																																																														
VM2274A0	GROOVED BUSHING	1.000	PC																																																																														
VM2275A0	SMOOTH BUSHING	1.000	PC																																																																														
VM2284B0	750 SERIES DRIP PROFILE KIT	1.000	PC																																																																														
VM2305A0	MM SERIES DOOR CAP FIXING PAWL	14.000	PC																																																																														
VM2312A0	MM DRIP PROFILE DRAIN LEFT PIPE	1.000	PC																																																																														
VM2314A0	MM DRIP PROFILE CAP	1.000	PC																																																																														
VM2315B0	S6 INTERNAL GLASS SUPPORT	3.000	PC																																																																														
VM2505B1	MM PLUS INTERNAL GLASS SUPPORT	3.000	PC																																																																														



COMPONENT			SPARE PART																																															
Code	Description	Image	Code	Description	Kit components																																													
OB1107A	XEVC-0511-E LEFT INT DOOR COLUMN		KDR1325A	0511 ZERO RIGHT -M EXTERNAL DOOR	<table border="1"> <thead> <tr> <th>Code</th> <th>Description</th> <th>Qty</th> <th>UOM</th> </tr> </thead> <tbody> <tr> <td>VP1080A0</td> <td>UPPER HINGE CAP FOR LOWER INNER GLASS</td> <td>1.000</td> <td>PC</td> </tr> <tr> <td>VP1081A0</td> <td>UPPER HINGE CAP FOR UPPER INNER GLASS</td> <td>1.000</td> <td>PC</td> </tr> <tr> <td>VT1276A0</td> <td>XEVC-0511-E DOOR EXTERNAL GLASS</td> <td>1.000</td> <td>PC</td> </tr> </tbody> </table>	Code	Description	Qty	UOM	VP1080A0	UPPER HINGE CAP FOR LOWER INNER GLASS	1.000	PC	VP1081A0	UPPER HINGE CAP FOR UPPER INNER GLASS	1.000	PC	VT1276A0	XEVC-0511-E DOOR EXTERNAL GLASS	1.000	PC																													
			Code	Description	Qty	UOM																																												
VP1080A0	UPPER HINGE CAP FOR LOWER INNER GLASS	1.000	PC																																															
VP1081A0	UPPER HINGE CAP FOR UPPER INNER GLASS	1.000	PC																																															
VT1276A0	XEVC-0511-E DOOR EXTERNAL GLASS	1.000	PC																																															
KDR1269B	BT-04 -M EXTERNAL RIGHT DOOR	<table border="1"> <thead> <tr> <th>Code</th> <th>Description</th> <th>Qty</th> <th>UOM</th> </tr> </thead> <tbody> <tr> <td>OB1107A1</td> <td>XEVC-0511-E LEFT INT DOOR COLUM</td> <td>1.000</td> <td>PC</td> </tr> <tr> <td>OB1108B1</td> <td>XEVC-0511 DOOR EXTERNAL RIGHT COLUM</td> <td>1.000</td> <td>PC</td> </tr> <tr> <td>OB1109A1</td> <td>XEVC-0511-E RIGHT INT DOOR COLUM</td> <td>1.000</td> <td>PC</td> </tr> <tr> <td>OB1126B0</td> <td>860mm DOOR LOWER BEAM</td> <td>1.000</td> <td>PC</td> </tr> <tr> <td>OB1166A1</td> <td>XEVC-0511-E EXT GLASS SUPPORT PROFILE</td> <td>2.000</td> <td>PC</td> </tr> <tr> <td>OB1174A0</td> <td>XEBC-04EU-E LEFT EXT DOOR COLUM</td> <td>1.000</td> <td>PC</td> </tr> <tr> <td>OB1218B0</td> <td>860MM DOUBLE GLASS DOOR UPPER BEAM</td> <td>1.000</td> <td>PC</td> </tr> <tr> <td>OB1219A1</td> <td>MM DOUBLE GLASS DOOR INT UPPER BEAM 860</td> <td>1.000</td> <td>PC</td> </tr> <tr> <td>CE1052A1</td> <td>MM USB-CONTRO L PANEL CONNECTING CABLE</td> <td>1.000</td> <td>PC</td> </tr> <tr> <td>CE1053B0</td> <td>MM MICROFIT LED BAR POWER SUPPLY CABL</td> <td>1.000</td> <td>PC</td> </tr> <tr> <td>CE1097A0</td> <td>4M SIHF 4 POLES MICROFIT CANBUS</td> <td>1.000</td> <td>PC</td> </tr> </tbody> </table>	Code	Description	Qty	UOM	OB1107A1	XEVC-0511-E LEFT INT DOOR COLUM	1.000	PC	OB1108B1	XEVC-0511 DOOR EXTERNAL RIGHT COLUM	1.000	PC	OB1109A1	XEVC-0511-E RIGHT INT DOOR COLUM	1.000	PC	OB1126B0	860mm DOOR LOWER BEAM	1.000	PC	OB1166A1	XEVC-0511-E EXT GLASS SUPPORT PROFILE	2.000	PC	OB1174A0	XEBC-04EU-E LEFT EXT DOOR COLUM	1.000	PC	OB1218B0	860MM DOUBLE GLASS DOOR UPPER BEAM	1.000	PC	OB1219A1	MM DOUBLE GLASS DOOR INT UPPER BEAM 860	1.000	PC	CE1052A1	MM USB-CONTRO L PANEL CONNECTING CABLE	1.000	PC	CE1053B0	MM MICROFIT LED BAR POWER SUPPLY CABL	1.000	PC	CE1097A0	4M SIHF 4 POLES MICROFIT CANBUS	1.000	PC
Code	Description	Qty	UOM																																															
OB1107A1	XEVC-0511-E LEFT INT DOOR COLUM	1.000	PC																																															
OB1108B1	XEVC-0511 DOOR EXTERNAL RIGHT COLUM	1.000	PC																																															
OB1109A1	XEVC-0511-E RIGHT INT DOOR COLUM	1.000	PC																																															
OB1126B0	860mm DOOR LOWER BEAM	1.000	PC																																															
OB1166A1	XEVC-0511-E EXT GLASS SUPPORT PROFILE	2.000	PC																																															
OB1174A0	XEBC-04EU-E LEFT EXT DOOR COLUM	1.000	PC																																															
OB1218B0	860MM DOUBLE GLASS DOOR UPPER BEAM	1.000	PC																																															
OB1219A1	MM DOUBLE GLASS DOOR INT UPPER BEAM 860	1.000	PC																																															
CE1052A1	MM USB-CONTRO L PANEL CONNECTING CABLE	1.000	PC																																															
CE1053B0	MM MICROFIT LED BAR POWER SUPPLY CABL	1.000	PC																																															
CE1097A0	4M SIHF 4 POLES MICROFIT CANBUS	1.000	PC																																															



COMPONENT			SPARE PART																																																																						
Code	Description	Image	Code	Description	Kit components																																																																				
OB1107A	XEVC-0511-E LEFT INT DOOR COLUMN		KDR1269B	BT-04 -M EXTERNAL RIGHT DOOR	<table border="1"> <thead> <tr> <th>Code</th> <th>Description</th> <th>Qty</th> <th>UOM</th> </tr> </thead> <tbody> <tr> <td>CE1285A0</td> <td>EMI ROUND FERRITE MOD.26438015 02</td> <td>2.000</td> <td>PC</td> </tr> <tr> <td>LP1019A0</td> <td>6 SERIES L200 LED LIGHT BAR - E415</td> <td>1.000</td> <td>PC</td> </tr> <tr> <td>LP1025A0</td> <td>L=415 LED LIGHT BAR COVER</td> <td>1.000</td> <td>PC</td> </tr> <tr> <td>MG1099A1</td> <td>MM COMPLETE HANDLE</td> <td>1.000</td> <td>PC</td> </tr> <tr> <td>RC1200A0</td> <td>ED=4 WIRE D=0.5 H24 COMPRESSIO N SPRING</td> <td>4.000</td> <td>PC</td> </tr> <tr> <td>SL1170A1</td> <td>S57 BLACK SILICON - 310ml CARTRIDGE</td> <td>35.000</td> <td>ML</td> </tr> <tr> <td>SL1222A0</td> <td>0511 EXTERNAL GLASS LATERAL SILICONE</td> <td>4.000</td> <td>PC</td> </tr> <tr> <td>SL1229A0</td> <td>BAKER EXTERNAL GLASS UPPER SILICONE</td> <td>1.000</td> <td>PC</td> </tr> <tr> <td>VE1030A1</td> <td>MAGNET FOR DOOR MICROSWITC H D=22,9mm</td> <td>1.000</td> <td>PC</td> </tr> <tr> <td>VI0239A1</td> <td>SELF-TAPPIN G SCREW 4.2X25 TCB+ INOX</td> <td>4.000</td> <td>PC</td> </tr> <tr> <td>VI1074A0</td> <td>4X16 SCREW FOR PLASTIC</td> <td>2.000</td> <td>PC</td> </tr> <tr> <td>VI1103A0</td> <td>40X12 TBSP SCREW FOR PLASTIC</td> <td>4.000</td> <td>PC</td> </tr> <tr> <td>VI1220A1</td> <td>4,2x12 TCB SELF-TAPPIN G SCREW</td> <td>28.000</td> <td>PC</td> </tr> <tr> <td>VI1930A1</td> <td>5x20 ST. STEEL CHIP SCREW</td> <td>16.000</td> <td>PC</td> </tr> <tr> <td>VI1996A0</td> <td>M5x35 SCREW</td> <td>13.000</td> <td>PC</td> </tr> <tr> <td>VI2070A0</td> <td>SHEETTRACS TCB+ 40x8 SELF-THREAD SCREW</td> <td>6.000</td> <td>PC</td> </tr> </tbody> </table>	Code	Description	Qty	UOM	CE1285A0	EMI ROUND FERRITE MOD.26438015 02	2.000	PC	LP1019A0	6 SERIES L200 LED LIGHT BAR - E415	1.000	PC	LP1025A0	L=415 LED LIGHT BAR COVER	1.000	PC	MG1099A1	MM COMPLETE HANDLE	1.000	PC	RC1200A0	ED=4 WIRE D=0.5 H24 COMPRESSIO N SPRING	4.000	PC	SL1170A1	S57 BLACK SILICON - 310ml CARTRIDGE	35.000	ML	SL1222A0	0511 EXTERNAL GLASS LATERAL SILICONE	4.000	PC	SL1229A0	BAKER EXTERNAL GLASS UPPER SILICONE	1.000	PC	VE1030A1	MAGNET FOR DOOR MICROSWITC H D=22,9mm	1.000	PC	VI0239A1	SELF-TAPPIN G SCREW 4.2X25 TCB+ INOX	4.000	PC	VI1074A0	4X16 SCREW FOR PLASTIC	2.000	PC	VI1103A0	40X12 TBSP SCREW FOR PLASTIC	4.000	PC	VI1220A1	4,2x12 TCB SELF-TAPPIN G SCREW	28.000	PC	VI1930A1	5x20 ST. STEEL CHIP SCREW	16.000	PC	VI1996A0	M5x35 SCREW	13.000	PC	VI2070A0	SHEETTRACS TCB+ 40x8 SELF-THREAD SCREW	6.000	PC
					Code	Description	Qty	UOM																																																																	
					CE1285A0	EMI ROUND FERRITE MOD.26438015 02	2.000	PC																																																																	
					LP1019A0	6 SERIES L200 LED LIGHT BAR - E415	1.000	PC																																																																	
					LP1025A0	L=415 LED LIGHT BAR COVER	1.000	PC																																																																	
					MG1099A1	MM COMPLETE HANDLE	1.000	PC																																																																	
					RC1200A0	ED=4 WIRE D=0.5 H24 COMPRESSIO N SPRING	4.000	PC																																																																	
					SL1170A1	S57 BLACK SILICON - 310ml CARTRIDGE	35.000	ML																																																																	
					SL1222A0	0511 EXTERNAL GLASS LATERAL SILICONE	4.000	PC																																																																	
					SL1229A0	BAKER EXTERNAL GLASS UPPER SILICONE	1.000	PC																																																																	
					VE1030A1	MAGNET FOR DOOR MICROSWITC H D=22,9mm	1.000	PC																																																																	
					VI0239A1	SELF-TAPPIN G SCREW 4.2X25 TCB+ INOX	4.000	PC																																																																	
					VI1074A0	4X16 SCREW FOR PLASTIC	2.000	PC																																																																	
					VI1103A0	40X12 TBSP SCREW FOR PLASTIC	4.000	PC																																																																	
					VI1220A1	4,2x12 TCB SELF-TAPPIN G SCREW	28.000	PC																																																																	
VI1930A1	5x20 ST. STEEL CHIP SCREW	16.000	PC																																																																						
VI1996A0	M5x35 SCREW	13.000	PC																																																																						
VI2070A0	SHEETTRACS TCB+ 40x8 SELF-THREAD SCREW	6.000	PC																																																																						



COMPONENT			SPARE PART																																																																														
Code	Description	Image	Code	Description	Kit components																																																																												
OB1107A	XEVC-0511-E LEFT INT DOOR COLUMN		KDR1269B	BT-04 -M EXTERNAL RIGHT DOOR	<table border="1"> <thead> <tr> <th>Code</th> <th>Description</th> <th>Qty</th> <th>UOM</th> </tr> </thead> <tbody> <tr> <td>VM1490A0</td> <td>CHEFTOP/BAK ERTOP HANDLE SCREWS COVER</td> <td>2.000</td> <td>PC</td> </tr> <tr> <td>VM1630A1</td> <td>INTERNAL GLASS PUSHING CAP</td> <td>3.000</td> <td>PC</td> </tr> <tr> <td>VM1631A0</td> <td>PLUS INNER GLASS PUSHING CAP</td> <td>3.000</td> <td>PC</td> </tr> <tr> <td>VM2259B0</td> <td>VM2259B0</td> <td>1.000</td> <td>PC</td> </tr> <tr> <td>VM2260B0</td> <td>S6 LEFT UPPER CAP</td> <td>1.000</td> <td>PC</td> </tr> <tr> <td>VM2261B0</td> <td>MM -M DOOR RIGHT LOWER CAP</td> <td>1.000</td> <td>PC</td> </tr> <tr> <td>VM2262B0</td> <td>MM -M DOOR RIGHT UPPER CAP</td> <td>1.000</td> <td>PC</td> </tr> <tr> <td>VM2267A0</td> <td>INTERNAL GLASS LOCKING SYSTEM SLIDER</td> <td>2.000</td> <td>PC</td> </tr> <tr> <td>VM2268A0</td> <td>DOOR MAGNET COVER</td> <td>2.000</td> <td>PC</td> </tr> <tr> <td>VM2269B0</td> <td>INNER GLASS FIXING CAP</td> <td>2.000</td> <td>PC</td> </tr> <tr> <td>VM2274A0</td> <td>GROOVED BUSHING</td> <td>1.000</td> <td>PC</td> </tr> <tr> <td>VM2275A0</td> <td>SMOOTH BUSHING</td> <td>1.000</td> <td>PC</td> </tr> <tr> <td>VM2285B0</td> <td>860 SERIES DRIP PROFILE KIT</td> <td>1.000</td> <td>PC</td> </tr> <tr> <td>VM2305A0</td> <td>MM SERIES DOOR CAP FIXING PAWL</td> <td>14.000</td> <td>PC</td> </tr> <tr> <td>VM2312A0</td> <td>MM DRIP PROFILE DRAIN LEFT PIPE</td> <td>1.000</td> <td>PC</td> </tr> <tr> <td>VM2314A0</td> <td>MM DRIP PROFILE CAP</td> <td>1.000</td> <td>PC</td> </tr> <tr> <td>VM2315B0</td> <td>S6 INTERNAL GLASS SUPPORT</td> <td>3.000</td> <td>PC</td> </tr> <tr> <td>VM2505B1</td> <td>MM PLUS INTERNAL GLASS SUPPORT</td> <td>3.000</td> <td>PC</td> </tr> </tbody> </table>	Code	Description	Qty	UOM	VM1490A0	CHEFTOP/BAK ERTOP HANDLE SCREWS COVER	2.000	PC	VM1630A1	INTERNAL GLASS PUSHING CAP	3.000	PC	VM1631A0	PLUS INNER GLASS PUSHING CAP	3.000	PC	VM2259B0	VM2259B0	1.000	PC	VM2260B0	S6 LEFT UPPER CAP	1.000	PC	VM2261B0	MM -M DOOR RIGHT LOWER CAP	1.000	PC	VM2262B0	MM -M DOOR RIGHT UPPER CAP	1.000	PC	VM2267A0	INTERNAL GLASS LOCKING SYSTEM SLIDER	2.000	PC	VM2268A0	DOOR MAGNET COVER	2.000	PC	VM2269B0	INNER GLASS FIXING CAP	2.000	PC	VM2274A0	GROOVED BUSHING	1.000	PC	VM2275A0	SMOOTH BUSHING	1.000	PC	VM2285B0	860 SERIES DRIP PROFILE KIT	1.000	PC	VM2305A0	MM SERIES DOOR CAP FIXING PAWL	14.000	PC	VM2312A0	MM DRIP PROFILE DRAIN LEFT PIPE	1.000	PC	VM2314A0	MM DRIP PROFILE CAP	1.000	PC	VM2315B0	S6 INTERNAL GLASS SUPPORT	3.000	PC	VM2505B1	MM PLUS INTERNAL GLASS SUPPORT	3.000	PC
Code	Description	Qty	UOM																																																																														
VM1490A0	CHEFTOP/BAK ERTOP HANDLE SCREWS COVER	2.000	PC																																																																														
VM1630A1	INTERNAL GLASS PUSHING CAP	3.000	PC																																																																														
VM1631A0	PLUS INNER GLASS PUSHING CAP	3.000	PC																																																																														
VM2259B0	VM2259B0	1.000	PC																																																																														
VM2260B0	S6 LEFT UPPER CAP	1.000	PC																																																																														
VM2261B0	MM -M DOOR RIGHT LOWER CAP	1.000	PC																																																																														
VM2262B0	MM -M DOOR RIGHT UPPER CAP	1.000	PC																																																																														
VM2267A0	INTERNAL GLASS LOCKING SYSTEM SLIDER	2.000	PC																																																																														
VM2268A0	DOOR MAGNET COVER	2.000	PC																																																																														
VM2269B0	INNER GLASS FIXING CAP	2.000	PC																																																																														
VM2274A0	GROOVED BUSHING	1.000	PC																																																																														
VM2275A0	SMOOTH BUSHING	1.000	PC																																																																														
VM2285B0	860 SERIES DRIP PROFILE KIT	1.000	PC																																																																														
VM2305A0	MM SERIES DOOR CAP FIXING PAWL	14.000	PC																																																																														
VM2312A0	MM DRIP PROFILE DRAIN LEFT PIPE	1.000	PC																																																																														
VM2314A0	MM DRIP PROFILE CAP	1.000	PC																																																																														
VM2315B0	S6 INTERNAL GLASS SUPPORT	3.000	PC																																																																														
VM2505B1	MM PLUS INTERNAL GLASS SUPPORT	3.000	PC																																																																														



COMPONENT			SPARE PART																																							
Code	Description	Image	Code	Description	Kit components																																					
0B1107A	XEVC-0511-E LEFT INT DOOR COLUMN		KDR1269B	BT-04 -M EXTERNAL RIGHT DOOR	<table border="1"> <thead> <tr> <th>Code</th> <th>Description</th> <th>Qty</th> <th>UOM</th> </tr> </thead> <tbody> <tr> <td>VM2518A0</td> <td>BOARD COOLING FAN SUPPORT</td> <td>1.000</td> <td>PC</td> </tr> <tr> <td>VN1179A1</td> <td>CONTROL BOARD 40x40x20mm 12V COOLING FAN</td> <td>1.000</td> <td>PC</td> </tr> <tr> <td>VP1080A0</td> <td>UPPER HINGE CAP FOR LOWER INNER GLASS</td> <td>1.000</td> <td>PC</td> </tr> <tr> <td>VP1081A0</td> <td>UPPER HINGE CAP FOR UPPER INNER GLASS</td> <td>1.000</td> <td>PC</td> </tr> <tr> <td>VT1290A0</td> <td>EXTERNAL GLASS XEBC-04EU-E</td> <td>1.000</td> <td>PC</td> </tr> </tbody> </table>	Code	Description	Qty	UOM	VM2518A0	BOARD COOLING FAN SUPPORT	1.000	PC	VN1179A1	CONTROL BOARD 40x40x20mm 12V COOLING FAN	1.000	PC	VP1080A0	UPPER HINGE CAP FOR LOWER INNER GLASS	1.000	PC	VP1081A0	UPPER HINGE CAP FOR UPPER INNER GLASS	1.000	PC	VT1290A0	EXTERNAL GLASS XEBC-04EU-E	1.000	PC													
			Code	Description	Qty	UOM																																				
VM2518A0	BOARD COOLING FAN SUPPORT	1.000	PC																																							
VN1179A1	CONTROL BOARD 40x40x20mm 12V COOLING FAN	1.000	PC																																							
VP1080A0	UPPER HINGE CAP FOR LOWER INNER GLASS	1.000	PC																																							
VP1081A0	UPPER HINGE CAP FOR UPPER INNER GLASS	1.000	PC																																							
VT1290A0	EXTERNAL GLASS XEBC-04EU-E	1.000	PC																																							
KDR1269A	BT-04 EXTERNAL RIGHT DOOR	<table border="1"> <thead> <tr> <th>Code</th> <th>Description</th> <th>Qty</th> <th>UOM</th> </tr> </thead> <tbody> <tr> <td>0B1107A1</td> <td>XEVC-0511-E LEFT INT DOOR COLUMN</td> <td>1.000</td> <td>PC</td> </tr> <tr> <td>0B1108B1</td> <td>XEVC-0511 DOOR EXTERNAL RIGHT COLUMN</td> <td>1.000</td> <td>PC</td> </tr> <tr> <td>0B1109A1</td> <td>XEVC-0511-E RIGHT INT DOOR COLUMN</td> <td>1.000</td> <td>PC</td> </tr> <tr> <td>0B1126A1</td> <td>860mm DOOR LOWER FRAME SHAPE</td> <td>1.000</td> <td>PC</td> </tr> <tr> <td>0B1166A1</td> <td>XEVC-0511-E EXT GLASS SUPPORT PROFILE</td> <td>2.000</td> <td>PC</td> </tr> <tr> <td>0B1174A0</td> <td>XEBC-04EU-E LEFT EXT DOOR COLUMN</td> <td>1.000</td> <td>PC</td> </tr> <tr> <td>0B1218A1</td> <td>860MM DOUBLE GLASS DOOR UPPER BEAM</td> <td>1.000</td> <td>PC</td> </tr> <tr> <td>0B1219A1</td> <td>MM DOUBLE GLASS DOOR INT UPPER BEAM 860</td> <td>1.000</td> <td>PC</td> </tr> <tr> <td>CE1052A1</td> <td>MM USB-CONTRO L PANEL CONNECTING CABLE</td> <td>1.000</td> <td>PC</td> </tr> </tbody> </table>	Code	Description	Qty	UOM	0B1107A1	XEVC-0511-E LEFT INT DOOR COLUMN	1.000	PC	0B1108B1	XEVC-0511 DOOR EXTERNAL RIGHT COLUMN	1.000	PC	0B1109A1	XEVC-0511-E RIGHT INT DOOR COLUMN	1.000	PC	0B1126A1	860mm DOOR LOWER FRAME SHAPE	1.000	PC	0B1166A1	XEVC-0511-E EXT GLASS SUPPORT PROFILE	2.000	PC	0B1174A0	XEBC-04EU-E LEFT EXT DOOR COLUMN	1.000	PC	0B1218A1	860MM DOUBLE GLASS DOOR UPPER BEAM	1.000	PC	0B1219A1	MM DOUBLE GLASS DOOR INT UPPER BEAM 860	1.000	PC	CE1052A1	MM USB-CONTRO L PANEL CONNECTING CABLE	1.000	PC
Code	Description	Qty	UOM																																							
0B1107A1	XEVC-0511-E LEFT INT DOOR COLUMN	1.000	PC																																							
0B1108B1	XEVC-0511 DOOR EXTERNAL RIGHT COLUMN	1.000	PC																																							
0B1109A1	XEVC-0511-E RIGHT INT DOOR COLUMN	1.000	PC																																							
0B1126A1	860mm DOOR LOWER FRAME SHAPE	1.000	PC																																							
0B1166A1	XEVC-0511-E EXT GLASS SUPPORT PROFILE	2.000	PC																																							
0B1174A0	XEBC-04EU-E LEFT EXT DOOR COLUMN	1.000	PC																																							
0B1218A1	860MM DOUBLE GLASS DOOR UPPER BEAM	1.000	PC																																							
0B1219A1	MM DOUBLE GLASS DOOR INT UPPER BEAM 860	1.000	PC																																							
CE1052A1	MM USB-CONTRO L PANEL CONNECTING CABLE	1.000	PC																																							



COMPONENT			SPARE PART																																																																						
Code	Description	Image	Code	Description	Kit components																																																																				
OB1107A	XEVC-0511-E LEFT INT DOOR COLUMN		KDR1269A	BT-04 EXTERNAL RIGHT DOOR	<table border="1"> <thead> <tr> <th>Code</th> <th>Description</th> <th>Qty</th> <th>UOM</th> </tr> </thead> <tbody> <tr> <td>CE1053B0</td> <td>MM MICROFIT LED BAR POWER SUPPLY CABL</td> <td>1.000</td> <td>PC</td> </tr> <tr> <td>CE1285A0</td> <td>EMI ROUND FERRITE MOD.26438015 02</td> <td>1.000</td> <td>PC</td> </tr> <tr> <td>CE1290A0</td> <td>EXTRACTABL E FEMALE TERMINAL CPF 5/4</td> <td>1.000</td> <td>PC</td> </tr> <tr> <td>CE1310A1</td> <td>POWER - CONTROL BOARD CONNECTING CABLE</td> <td>1.000</td> <td>PC</td> </tr> <tr> <td>LP1019A0</td> <td>6 SERIES L200 LED LIGHT BAR - E415</td> <td>1.000</td> <td>PC</td> </tr> <tr> <td>LP1025A0</td> <td>L=415 LED LIGHT BAR COVER</td> <td>1.000</td> <td>PC</td> </tr> <tr> <td>MG1083A2</td> <td>MM COMPLETE HANDLE</td> <td>1.000</td> <td>PC</td> </tr> <tr> <td>SL1170A1</td> <td>S57 BLACK SILICON - 310ml CARTRIDGE</td> <td>30.000</td> <td>ML</td> </tr> <tr> <td>VE1030A1</td> <td>MAGNET FOR DOOR MICROSWITC H D=22,9mm</td> <td>1.000</td> <td>PC</td> </tr> <tr> <td>VH1147A0</td> <td>5X25 STAINLESS STEEL SCREW</td> <td>16.000</td> <td>PC</td> </tr> <tr> <td>VH1220A1</td> <td>4,2x12 TCB SELF-TAPPIN G SCREW</td> <td>25.000</td> <td>PC</td> </tr> <tr> <td>VH1996A0</td> <td>M5x35 SCREW</td> <td>13.000</td> <td>PC</td> </tr> <tr> <td>VM1630A1</td> <td>INTERNAL GLASS PUSHING CAP</td> <td>3.000</td> <td>PC</td> </tr> <tr> <td>VM1631A0</td> <td>PLUS INNER GLASS PUSHING CAP</td> <td>2.000</td> <td>PC</td> </tr> <tr> <td>VM2259A1</td> <td>6 SERIES DOOR LOWER LEFT CAP</td> <td>1.000</td> <td>PC</td> </tr> <tr> <td>VM2260A1</td> <td>6 SERIES DOOR UPPER LEFT CAP</td> <td>1.000</td> <td>PC</td> </tr> </tbody> </table>	Code	Description	Qty	UOM	CE1053B0	MM MICROFIT LED BAR POWER SUPPLY CABL	1.000	PC	CE1285A0	EMI ROUND FERRITE MOD.26438015 02	1.000	PC	CE1290A0	EXTRACTABL E FEMALE TERMINAL CPF 5/4	1.000	PC	CE1310A1	POWER - CONTROL BOARD CONNECTING CABLE	1.000	PC	LP1019A0	6 SERIES L200 LED LIGHT BAR - E415	1.000	PC	LP1025A0	L=415 LED LIGHT BAR COVER	1.000	PC	MG1083A2	MM COMPLETE HANDLE	1.000	PC	SL1170A1	S57 BLACK SILICON - 310ml CARTRIDGE	30.000	ML	VE1030A1	MAGNET FOR DOOR MICROSWITC H D=22,9mm	1.000	PC	VH1147A0	5X25 STAINLESS STEEL SCREW	16.000	PC	VH1220A1	4,2x12 TCB SELF-TAPPIN G SCREW	25.000	PC	VH1996A0	M5x35 SCREW	13.000	PC	VM1630A1	INTERNAL GLASS PUSHING CAP	3.000	PC	VM1631A0	PLUS INNER GLASS PUSHING CAP	2.000	PC	VM2259A1	6 SERIES DOOR LOWER LEFT CAP	1.000	PC	VM2260A1	6 SERIES DOOR UPPER LEFT CAP	1.000	PC
					Code	Description	Qty	UOM																																																																	
					CE1053B0	MM MICROFIT LED BAR POWER SUPPLY CABL	1.000	PC																																																																	
					CE1285A0	EMI ROUND FERRITE MOD.26438015 02	1.000	PC																																																																	
					CE1290A0	EXTRACTABL E FEMALE TERMINAL CPF 5/4	1.000	PC																																																																	
					CE1310A1	POWER - CONTROL BOARD CONNECTING CABLE	1.000	PC																																																																	
					LP1019A0	6 SERIES L200 LED LIGHT BAR - E415	1.000	PC																																																																	
					LP1025A0	L=415 LED LIGHT BAR COVER	1.000	PC																																																																	
					MG1083A2	MM COMPLETE HANDLE	1.000	PC																																																																	
					SL1170A1	S57 BLACK SILICON - 310ml CARTRIDGE	30.000	ML																																																																	
					VE1030A1	MAGNET FOR DOOR MICROSWITC H D=22,9mm	1.000	PC																																																																	
					VH1147A0	5X25 STAINLESS STEEL SCREW	16.000	PC																																																																	
					VH1220A1	4,2x12 TCB SELF-TAPPIN G SCREW	25.000	PC																																																																	
					VH1996A0	M5x35 SCREW	13.000	PC																																																																	
					VM1630A1	INTERNAL GLASS PUSHING CAP	3.000	PC																																																																	
					VM1631A0	PLUS INNER GLASS PUSHING CAP	2.000	PC																																																																	
VM2259A1	6 SERIES DOOR LOWER LEFT CAP	1.000	PC																																																																						
VM2260A1	6 SERIES DOOR UPPER LEFT CAP	1.000	PC																																																																						



COMPONENT			SPARE PART					
Code	Description	Image	Code	Description	Kit components			
OB1107A	XEVC-0511-E LEFT INT DOOR COLUMN		KDR1269A	BT-04 EXTERNAL RIGHT DOOR	Code	Description	Qty	UOM
					VM2261A1	MM DOOR LOWER RIGHT CAP	1.000	PC
					VM2262A1	MM DOOR UPPER RIGHT CAP	1.000	PC
					VM2267A0	INTERNAL GLASS LOCKING SYSTEM SLIDER	2.000	PC
					VM2268A0	DOOR MAGNET COVER	2.000	PC
					VM2269A0	INTERNAL GLASS LOCKING SYSTEM CAP	2.000	PC
					VM2274A0	GROOVED BUSHING	1.000	PC
					VM2275A0	SMOOTH BUSHING	1.000	PC
					VM2285A0	860 SERIES DRIP PROFILE	1.000	PC
					VM2305A0	MM SERIES DOOR CAP FIXING PAWL	14.000	PC
					VM2312A0	MM DRIP PROFILE DRAIN LEFT PIPE	1.000	PC
					VM2313A0	MM DRIP TRAY RIGHT DRAIN PIPE	1.000	PC
					VM2314A0	MM DRIP PROFILE CAP	1.000	PC
					VM2315A0	MIND.Maps INTERNAL GLASS CAP SUPPORT	3.000	PC
					VM2505A0	MM PLUS INTERNAL GLASS SUPPORT	2.000	PC
					VM2518A0	BOARD COOLING FAN SUPPORT	1.000	PC
					VN1179A1	CONTROL BOARD 40x40x20mm 12V COOLING FAN	1.000	PC
VT1290A0	EXTERNAL GLASS XEBC-04EU-E	1.000	PC					



COMPONENT			SPARE PART																																																																		
Code	Description	Image	Code	Description	Kit components																																																																
OB1107A	XEVC-0511-E LEFT INT DOOR COLUMN		KDR1261B	0511 -M RIGHT EXTERNAL DOOR	<table border="1"> <thead> <tr> <th>Code</th> <th>Description</th> <th>Qty</th> <th>UOM</th> </tr> </thead> <tbody> <tr> <td>OB1106A0</td> <td>XEVC-0511-E DOOR EXTERNAL LEFT COLUMN</td> <td>1.000</td> <td>PC</td> </tr> <tr> <td>OB1107A1</td> <td>XEVC-0511-E LEFT INT DOOR COLUMN</td> <td>1.000</td> <td>PC</td> </tr> <tr> <td>OB1108B1</td> <td>XEVC-0511 DOOR EXTERNAL RIGHT COLUMN</td> <td>1.000</td> <td>PC</td> </tr> <tr> <td>OB1109A1</td> <td>XEVC-0511-E RIGHT INT DOOR COLUMN</td> <td>1.000</td> <td>PC</td> </tr> <tr> <td>OB1122B0</td> <td>MM CT 750mm DOOR LOWER BEAM</td> <td>1.000</td> <td>PC</td> </tr> <tr> <td>OB1166A1</td> <td>XEVC-0511-E EXT GLASS SUPPORT PROFILE</td> <td>2.000</td> <td>PC</td> </tr> <tr> <td>OB1216B0</td> <td>MM DOUBLE GLASS DOOR 750mm UPPER BEAM</td> <td>1.000</td> <td>PC</td> </tr> <tr> <td>OB1217A1</td> <td>MM DOUBLE GLASS DOOR INT UPPER BEAM 750</td> <td>1.000</td> <td>PC</td> </tr> <tr> <td>CE1052A1</td> <td>MM USB-CONTRO L PANEL CONNECTING CABLE</td> <td>1.000</td> <td>PC</td> </tr> <tr> <td>CE1053B0</td> <td>MM MICROFIT LED BAR POWER SUPPLY CABL</td> <td>1.000</td> <td>PC</td> </tr> <tr> <td>CE1096A0</td> <td>4 POLES MICROFIT 3 M BUS CABLE</td> <td>1.000</td> <td>PC</td> </tr> <tr> <td>CE1285A0</td> <td>EMI ROUND FERRITE MOD.26438015 02</td> <td>2.000</td> <td>PC</td> </tr> <tr> <td>GN1525A0</td> <td>O-RING INT DIAM 9,5 THK 1 NBR 70</td> <td>1.000</td> <td>PC</td> </tr> <tr> <td>LP1019A0</td> <td>6 SERIES L200 LED LIGHT BAR - E415</td> <td>1.000</td> <td>PC</td> </tr> <tr> <td>LP1025A0</td> <td>L=415 LED LIGHT BAR COVER</td> <td>1.000</td> <td>PC</td> </tr> </tbody> </table>	Code	Description	Qty	UOM	OB1106A0	XEVC-0511-E DOOR EXTERNAL LEFT COLUMN	1.000	PC	OB1107A1	XEVC-0511-E LEFT INT DOOR COLUMN	1.000	PC	OB1108B1	XEVC-0511 DOOR EXTERNAL RIGHT COLUMN	1.000	PC	OB1109A1	XEVC-0511-E RIGHT INT DOOR COLUMN	1.000	PC	OB1122B0	MM CT 750mm DOOR LOWER BEAM	1.000	PC	OB1166A1	XEVC-0511-E EXT GLASS SUPPORT PROFILE	2.000	PC	OB1216B0	MM DOUBLE GLASS DOOR 750mm UPPER BEAM	1.000	PC	OB1217A1	MM DOUBLE GLASS DOOR INT UPPER BEAM 750	1.000	PC	CE1052A1	MM USB-CONTRO L PANEL CONNECTING CABLE	1.000	PC	CE1053B0	MM MICROFIT LED BAR POWER SUPPLY CABL	1.000	PC	CE1096A0	4 POLES MICROFIT 3 M BUS CABLE	1.000	PC	CE1285A0	EMI ROUND FERRITE MOD.26438015 02	2.000	PC	GN1525A0	O-RING INT DIAM 9,5 THK 1 NBR 70	1.000	PC	LP1019A0	6 SERIES L200 LED LIGHT BAR - E415	1.000	PC	LP1025A0	L=415 LED LIGHT BAR COVER	1.000	PC
					Code	Description	Qty	UOM																																																													
					OB1106A0	XEVC-0511-E DOOR EXTERNAL LEFT COLUMN	1.000	PC																																																													
					OB1107A1	XEVC-0511-E LEFT INT DOOR COLUMN	1.000	PC																																																													
					OB1108B1	XEVC-0511 DOOR EXTERNAL RIGHT COLUMN	1.000	PC																																																													
					OB1109A1	XEVC-0511-E RIGHT INT DOOR COLUMN	1.000	PC																																																													
					OB1122B0	MM CT 750mm DOOR LOWER BEAM	1.000	PC																																																													
					OB1166A1	XEVC-0511-E EXT GLASS SUPPORT PROFILE	2.000	PC																																																													
					OB1216B0	MM DOUBLE GLASS DOOR 750mm UPPER BEAM	1.000	PC																																																													
					OB1217A1	MM DOUBLE GLASS DOOR INT UPPER BEAM 750	1.000	PC																																																													
					CE1052A1	MM USB-CONTRO L PANEL CONNECTING CABLE	1.000	PC																																																													
					CE1053B0	MM MICROFIT LED BAR POWER SUPPLY CABL	1.000	PC																																																													
					CE1096A0	4 POLES MICROFIT 3 M BUS CABLE	1.000	PC																																																													
					CE1285A0	EMI ROUND FERRITE MOD.26438015 02	2.000	PC																																																													
					GN1525A0	O-RING INT DIAM 9,5 THK 1 NBR 70	1.000	PC																																																													
LP1019A0	6 SERIES L200 LED LIGHT BAR - E415	1.000	PC																																																																		
LP1025A0	L=415 LED LIGHT BAR COVER	1.000	PC																																																																		



COMPONENT			SPARE PART					
Code	Description	Image	Code	Description	Kit components			
OB1107A	XEVC-0511-E LEFT INT DOOR COLUMN		KDR1261B	0511 -M RIGHT EXTERNAL DOOR	Code	Description	Qty	UOM
					MG1099A1	MM COMPLETE HANDLE	1.000	PC
					RC1200A0	ED=4 WIRE D=0.5 H24 COMPRESSIO N SPRING	4.000	PC
					SL1170A1	S57 BLACK SILICON - 310ml CARTRIDGE	30.000	ML
					SL1221A0	GN1/1 EXTERNAL GLASS UPPER SILICONE	1.000	PC
					SL1222A0	0511 EXTERNAL GLASS LATERAL SILICONE	4.000	PC
					VE1030A1	MAGNET FOR DOOR MICROSWITC H D=22,9mm	1.000	PC
					VI0239A1	SELF-TAPPIN G SCREW 4,2X25 TCB+ INOX	4.000	PC
					VI1034A0	STAINLESS STEEL WASHER 8,4x16x1	1.000	PC
					VI1074A0	4X16 SCREW FOR PLASTIC	2.000	PC
					VI1103A0	40X12 TBSP SCREW FOR PLASTIC	2.000	PC
					VI1220A1	4,2x12 TCB SELF-TAPPIN G SCREW	26.000	PC
					VI1930A1	5x20 ST. STEEL CHIP SCREW	16.000	PC
					VI1996A0	M5x35 SCREW	13.000	PC
					VI2070A0	SHEETTRACS TCB+ 40x8 SELF-THREAD SCREW	6.000	PC
VM1490A0	CHEFTOP/BAK ERTOP HANDLE SCREWS COVER	2.000	PC					



COMPONENT			SPARE PART																																																																															
Code	Description	Image	Code	Description	Kit components																																																																													
OB1107A	XEVC-0511-E LEFT INT DOOR COLUMN		KDR1261B	0511 -M RIGHT EXTERNAL DOOR	<table border="1"> <thead> <tr> <th>Code</th> <th>Description</th> <th>Qty</th> <th>UOM</th> </tr> </thead> <tbody> <tr> <td>VM1630A1</td> <td>INTERNAL GLASS PUSHING CAP</td> <td>3.000</td> <td>PC</td> </tr> <tr> <td>VM1631A0</td> <td>PLUS INNER GLASS PUSHING CAP</td> <td>3.000</td> <td>PC</td> </tr> <tr> <td>VM2259B0</td> <td>VM2259B0</td> <td>1.000</td> <td>PC</td> </tr> <tr> <td>VM2260B0</td> <td>S6 LEFT UPPER CAP</td> <td>1.000</td> <td>PC</td> </tr> <tr> <td>VM2261B0</td> <td>MM -M DOOR RIGHT LOWER CAP</td> <td>1.000</td> <td>PC</td> </tr> <tr> <td>VM2262B0</td> <td>MM -M DOOR RIGHT UPPER CAP</td> <td>1.000</td> <td>PC</td> </tr> <tr> <td>VM2267A0</td> <td>INTERNAL GLASS LOCKING SYSTEM SLIDER</td> <td>2.000</td> <td>PC</td> </tr> <tr> <td>VM2268A0</td> <td>DOOR MAGNET COVER</td> <td>2.000</td> <td>PC</td> </tr> <tr> <td>VM2269B0</td> <td>INNER GLASS FIXING CAP</td> <td>2.000</td> <td>PC</td> </tr> <tr> <td>VM2274A0</td> <td>GROOVED BUSHING</td> <td>1.000</td> <td>PC</td> </tr> <tr> <td>VM2275A0</td> <td>SMOOTH BUSHING</td> <td>1.000</td> <td>PC</td> </tr> <tr> <td>VM2284B0</td> <td>750 SERIES DRIP PROFILE KIT</td> <td>1.000</td> <td>PC</td> </tr> <tr> <td>VM2305A0</td> <td>MM SERIES DOOR CAP FIXING PAWL</td> <td>14.000</td> <td>PC</td> </tr> <tr> <td>VM2312A0</td> <td>MM DRIP PROFILE DRAIN LEFT PIPE</td> <td>1.000</td> <td>PC</td> </tr> <tr> <td>VM2314A0</td> <td>MM DRIP PROFILE CAP</td> <td>1.000</td> <td>PC</td> </tr> <tr> <td>VM2315B0</td> <td>S6 INTERNAL GLASS SUPPORT</td> <td>3.000</td> <td>PC</td> </tr> <tr> <td>VM2505B1</td> <td>MM PLUS INTERNAL GLASS SUPPORT</td> <td>3.000</td> <td>PC</td> </tr> <tr> <td>VP1080A0</td> <td>UPPER HINGE CAP FOR LOWER INNER GLASS</td> <td>1.000</td> <td>PC</td> </tr> </tbody> </table>	Code	Description	Qty	UOM	VM1630A1	INTERNAL GLASS PUSHING CAP	3.000	PC	VM1631A0	PLUS INNER GLASS PUSHING CAP	3.000	PC	VM2259B0	VM2259B0	1.000	PC	VM2260B0	S6 LEFT UPPER CAP	1.000	PC	VM2261B0	MM -M DOOR RIGHT LOWER CAP	1.000	PC	VM2262B0	MM -M DOOR RIGHT UPPER CAP	1.000	PC	VM2267A0	INTERNAL GLASS LOCKING SYSTEM SLIDER	2.000	PC	VM2268A0	DOOR MAGNET COVER	2.000	PC	VM2269B0	INNER GLASS FIXING CAP	2.000	PC	VM2274A0	GROOVED BUSHING	1.000	PC	VM2275A0	SMOOTH BUSHING	1.000	PC	VM2284B0	750 SERIES DRIP PROFILE KIT	1.000	PC	VM2305A0	MM SERIES DOOR CAP FIXING PAWL	14.000	PC	VM2312A0	MM DRIP PROFILE DRAIN LEFT PIPE	1.000	PC	VM2314A0	MM DRIP PROFILE CAP	1.000	PC	VM2315B0	S6 INTERNAL GLASS SUPPORT	3.000	PC	VM2505B1	MM PLUS INTERNAL GLASS SUPPORT	3.000	PC	VP1080A0	UPPER HINGE CAP FOR LOWER INNER GLASS	1.000	PC	
Code	Description	Qty	UOM																																																																															
VM1630A1	INTERNAL GLASS PUSHING CAP	3.000	PC																																																																															
VM1631A0	PLUS INNER GLASS PUSHING CAP	3.000	PC																																																																															
VM2259B0	VM2259B0	1.000	PC																																																																															
VM2260B0	S6 LEFT UPPER CAP	1.000	PC																																																																															
VM2261B0	MM -M DOOR RIGHT LOWER CAP	1.000	PC																																																																															
VM2262B0	MM -M DOOR RIGHT UPPER CAP	1.000	PC																																																																															
VM2267A0	INTERNAL GLASS LOCKING SYSTEM SLIDER	2.000	PC																																																																															
VM2268A0	DOOR MAGNET COVER	2.000	PC																																																																															
VM2269B0	INNER GLASS FIXING CAP	2.000	PC																																																																															
VM2274A0	GROOVED BUSHING	1.000	PC																																																																															
VM2275A0	SMOOTH BUSHING	1.000	PC																																																																															
VM2284B0	750 SERIES DRIP PROFILE KIT	1.000	PC																																																																															
VM2305A0	MM SERIES DOOR CAP FIXING PAWL	14.000	PC																																																																															
VM2312A0	MM DRIP PROFILE DRAIN LEFT PIPE	1.000	PC																																																																															
VM2314A0	MM DRIP PROFILE CAP	1.000	PC																																																																															
VM2315B0	S6 INTERNAL GLASS SUPPORT	3.000	PC																																																																															
VM2505B1	MM PLUS INTERNAL GLASS SUPPORT	3.000	PC																																																																															
VP1080A0	UPPER HINGE CAP FOR LOWER INNER GLASS	1.000	PC																																																																															



COMPONENT			SPARE PART																																																			
Code	Description	Image	Code	Description	Kit components																																																	
0B1107A	XEVC-0511-E LEFT INT DOOR COLUMN		KDR1261B	0511 -M RIGHT EXTERNAL DOOR	<table border="1"> <thead> <tr> <th>Code</th> <th>Description</th> <th>Qty</th> <th>UOM</th> </tr> </thead> <tbody> <tr> <td>VP1081A0</td> <td>UPPER HINGE CAP FOR UPPER INNER GLASS</td> <td>1.000</td> <td>PC</td> </tr> <tr> <td>VT1276A0</td> <td>XEVC-0511-E DOOR EXTERNAL GLASS</td> <td>1.000</td> <td>PC</td> </tr> </tbody> </table>	Code	Description	Qty	UOM	VP1081A0	UPPER HINGE CAP FOR UPPER INNER GLASS	1.000	PC	VT1276A0	XEVC-0511-E DOOR EXTERNAL GLASS	1.000	PC																																					
			Code	Description	Qty	UOM																																																
VP1081A0	UPPER HINGE CAP FOR UPPER INNER GLASS	1.000	PC																																																			
VT1276A0	XEVC-0511-E DOOR EXTERNAL GLASS	1.000	PC																																																			
KDR1261A	0511 RIGHT EXTERNAL DOOR	<table border="1"> <thead> <tr> <th>Code</th> <th>Description</th> <th>Qty</th> <th>UOM</th> </tr> </thead> <tbody> <tr> <td>0B1106A0</td> <td>XEVC-0511-E DOOR EXTERNAL LEFT COLUMN</td> <td>1.000</td> <td>PC</td> </tr> <tr> <td>0B1107A1</td> <td>XEVC-0511-E LEFT INT DOOR COLUM</td> <td>1.000</td> <td>PC</td> </tr> <tr> <td>0B1108B1</td> <td>XEVC-0511 DOOR EXTERNAL RIGHT COLUM</td> <td>1.000</td> <td>PC</td> </tr> <tr> <td>0B1109A1</td> <td>XEVC-0511-E RIGHT INT DOOR COLUM</td> <td>1.000</td> <td>PC</td> </tr> <tr> <td>0B1122A1</td> <td>750MM DOOR LOWER FRAME SHAPE</td> <td>1.000</td> <td>PC</td> </tr> <tr> <td>0B1166A1</td> <td>XEVC-0511-E EXT GLASS SUPPORT PROFILE</td> <td>2.000</td> <td>PC</td> </tr> <tr> <td>0B1216A1</td> <td>MM CT DOUBLE GLASS DOOR UPPER BEAM</td> <td>1.000</td> <td>PC</td> </tr> <tr> <td>0B1217A1</td> <td>MM DOUBLE GLASS DOOR INT UPPER BEAM 750</td> <td>1.000</td> <td>PC</td> </tr> <tr> <td>CE1052A1</td> <td>MM USB-CONTRO L PANEL CONNECTING CABLE</td> <td>1.000</td> <td>PC</td> </tr> <tr> <td>CE1053B0</td> <td>MM MICROFIT LED BAR POWER SUPPLY CABL</td> <td>1.000</td> <td>PC</td> </tr> <tr> <td>CE1275A0</td> <td>3M POWER - CONTROL CONNECTION CABLE</td> <td>1.000</td> <td>PC</td> </tr> <tr> <td>CE1285A0</td> <td>EMI ROUND FERRITE MOD.26438015 02</td> <td>1.000</td> <td>PC</td> </tr> </tbody> </table>	Code	Description	Qty	UOM	0B1106A0	XEVC-0511-E DOOR EXTERNAL LEFT COLUMN	1.000	PC	0B1107A1	XEVC-0511-E LEFT INT DOOR COLUM	1.000	PC	0B1108B1	XEVC-0511 DOOR EXTERNAL RIGHT COLUM	1.000	PC	0B1109A1	XEVC-0511-E RIGHT INT DOOR COLUM	1.000	PC	0B1122A1	750MM DOOR LOWER FRAME SHAPE	1.000	PC	0B1166A1	XEVC-0511-E EXT GLASS SUPPORT PROFILE	2.000	PC	0B1216A1	MM CT DOUBLE GLASS DOOR UPPER BEAM	1.000	PC	0B1217A1	MM DOUBLE GLASS DOOR INT UPPER BEAM 750	1.000	PC	CE1052A1	MM USB-CONTRO L PANEL CONNECTING CABLE	1.000	PC	CE1053B0	MM MICROFIT LED BAR POWER SUPPLY CABL	1.000	PC	CE1275A0	3M POWER - CONTROL CONNECTION CABLE	1.000	PC	CE1285A0	EMI ROUND FERRITE MOD.26438015 02	1.000	PC
Code	Description	Qty	UOM																																																			
0B1106A0	XEVC-0511-E DOOR EXTERNAL LEFT COLUMN	1.000	PC																																																			
0B1107A1	XEVC-0511-E LEFT INT DOOR COLUM	1.000	PC																																																			
0B1108B1	XEVC-0511 DOOR EXTERNAL RIGHT COLUM	1.000	PC																																																			
0B1109A1	XEVC-0511-E RIGHT INT DOOR COLUM	1.000	PC																																																			
0B1122A1	750MM DOOR LOWER FRAME SHAPE	1.000	PC																																																			
0B1166A1	XEVC-0511-E EXT GLASS SUPPORT PROFILE	2.000	PC																																																			
0B1216A1	MM CT DOUBLE GLASS DOOR UPPER BEAM	1.000	PC																																																			
0B1217A1	MM DOUBLE GLASS DOOR INT UPPER BEAM 750	1.000	PC																																																			
CE1052A1	MM USB-CONTRO L PANEL CONNECTING CABLE	1.000	PC																																																			
CE1053B0	MM MICROFIT LED BAR POWER SUPPLY CABL	1.000	PC																																																			
CE1275A0	3M POWER - CONTROL CONNECTION CABLE	1.000	PC																																																			
CE1285A0	EMI ROUND FERRITE MOD.26438015 02	1.000	PC																																																			



COMPONENT			SPARE PART																																																																										
Code	Description	Image	Code	Description	Kit components																																																																								
0B1107A	XEVC-0511-E LEFT INT DOOR COLUMN		KDR1261A	0511 RIGHT EXTERNAL DOOR	<table border="1"> <thead> <tr> <th>Code</th> <th>Description</th> <th>Qty</th> <th>UOM</th> </tr> </thead> <tbody> <tr> <td>CE1290A0</td> <td>EXTRACTABL E FEMALE TERMINAL CPF 5/4</td> <td>1.000</td> <td>PC</td> </tr> <tr> <td>GN1525A0</td> <td>O-RING INT DIAM 9,5 THK 1 NBR 70</td> <td>1.000</td> <td>PC</td> </tr> <tr> <td>LP1019A0</td> <td>6 SERIES L200 LED LIGHT BAR - E415</td> <td>1.000</td> <td>PC</td> </tr> <tr> <td>LP1025A0</td> <td>L=415 LED LIGHT BAR COVER</td> <td>1.000</td> <td>PC</td> </tr> <tr> <td>MG1083A2</td> <td>MM COMPLETE HANDLE</td> <td>1.000</td> <td>PC</td> </tr> <tr> <td>SL1170A1</td> <td>S57 BLACK SILICON - 310ml CARTRIDGE</td> <td>30.000</td> <td>ML</td> </tr> <tr> <td>VE1030A1</td> <td>MAGNET FOR DOOR MICROSWITC H D=22,9mm</td> <td>1.000</td> <td>PC</td> </tr> <tr> <td>VI1034A0</td> <td>STAINLESS STEEL WASHER 8,4x16x1</td> <td>1.000</td> <td>PC</td> </tr> <tr> <td>VI1147A0</td> <td>5X25 STAINLESS STEEL SCREW</td> <td>16.000</td> <td>PC</td> </tr> <tr> <td>VI1220A1</td> <td>4,2x12 TCB SELF-TAPPIN G SCREW</td> <td>25.000</td> <td>PC</td> </tr> <tr> <td>VI1996A0</td> <td>M5x35 SCREW</td> <td>13.000</td> <td>PC</td> </tr> <tr> <td>VM1630A1</td> <td>INTERNAL GLASS PUSHING CAP</td> <td>3.000</td> <td>PC</td> </tr> <tr> <td>VM1631A0</td> <td>PLUS INNER GLASS PUSHING CAP</td> <td>2.000</td> <td>PC</td> </tr> <tr> <td>VM2259A1</td> <td>6 SERIES DOOR LOWER LEFT CAP</td> <td>1.000</td> <td>PC</td> </tr> <tr> <td>VM2260A1</td> <td>6 SERIES DOOR UPPER LEFT CAP</td> <td>1.000</td> <td>PC</td> </tr> <tr> <td>VM2261A1</td> <td>MM DOOR LOWER RIGHT CAP</td> <td>1.000</td> <td>PC</td> </tr> <tr> <td>VM2262A1</td> <td>MM DOOR UPPER RIGHT CAP</td> <td>1.000</td> <td>PC</td> </tr> </tbody> </table>	Code	Description	Qty	UOM	CE1290A0	EXTRACTABL E FEMALE TERMINAL CPF 5/4	1.000	PC	GN1525A0	O-RING INT DIAM 9,5 THK 1 NBR 70	1.000	PC	LP1019A0	6 SERIES L200 LED LIGHT BAR - E415	1.000	PC	LP1025A0	L=415 LED LIGHT BAR COVER	1.000	PC	MG1083A2	MM COMPLETE HANDLE	1.000	PC	SL1170A1	S57 BLACK SILICON - 310ml CARTRIDGE	30.000	ML	VE1030A1	MAGNET FOR DOOR MICROSWITC H D=22,9mm	1.000	PC	VI1034A0	STAINLESS STEEL WASHER 8,4x16x1	1.000	PC	VI1147A0	5X25 STAINLESS STEEL SCREW	16.000	PC	VI1220A1	4,2x12 TCB SELF-TAPPIN G SCREW	25.000	PC	VI1996A0	M5x35 SCREW	13.000	PC	VM1630A1	INTERNAL GLASS PUSHING CAP	3.000	PC	VM1631A0	PLUS INNER GLASS PUSHING CAP	2.000	PC	VM2259A1	6 SERIES DOOR LOWER LEFT CAP	1.000	PC	VM2260A1	6 SERIES DOOR UPPER LEFT CAP	1.000	PC	VM2261A1	MM DOOR LOWER RIGHT CAP	1.000	PC	VM2262A1	MM DOOR UPPER RIGHT CAP	1.000	PC
					Code	Description	Qty	UOM																																																																					
					CE1290A0	EXTRACTABL E FEMALE TERMINAL CPF 5/4	1.000	PC																																																																					
					GN1525A0	O-RING INT DIAM 9,5 THK 1 NBR 70	1.000	PC																																																																					
					LP1019A0	6 SERIES L200 LED LIGHT BAR - E415	1.000	PC																																																																					
					LP1025A0	L=415 LED LIGHT BAR COVER	1.000	PC																																																																					
					MG1083A2	MM COMPLETE HANDLE	1.000	PC																																																																					
					SL1170A1	S57 BLACK SILICON - 310ml CARTRIDGE	30.000	ML																																																																					
					VE1030A1	MAGNET FOR DOOR MICROSWITC H D=22,9mm	1.000	PC																																																																					
					VI1034A0	STAINLESS STEEL WASHER 8,4x16x1	1.000	PC																																																																					
					VI1147A0	5X25 STAINLESS STEEL SCREW	16.000	PC																																																																					
					VI1220A1	4,2x12 TCB SELF-TAPPIN G SCREW	25.000	PC																																																																					
					VI1996A0	M5x35 SCREW	13.000	PC																																																																					
					VM1630A1	INTERNAL GLASS PUSHING CAP	3.000	PC																																																																					
					VM1631A0	PLUS INNER GLASS PUSHING CAP	2.000	PC																																																																					
					VM2259A1	6 SERIES DOOR LOWER LEFT CAP	1.000	PC																																																																					
					VM2260A1	6 SERIES DOOR UPPER LEFT CAP	1.000	PC																																																																					
VM2261A1	MM DOOR LOWER RIGHT CAP	1.000	PC																																																																										
VM2262A1	MM DOOR UPPER RIGHT CAP	1.000	PC																																																																										



COMPONENT			SPARE PART																																																														
Code	Description	Image	Code	Description	Kit components																																																												
OB1107A	XEVC-0511-E LEFT INT DOOR COLUMN		KDR1261A	0511 RIGHT EXTERNAL DOOR	<table border="1"> <thead> <tr> <th>Code</th> <th>Description</th> <th>Qty</th> <th>UOM</th> </tr> </thead> <tbody> <tr> <td>VM2267A0</td> <td>INTERNAL GLASS LOCKING SYSTEM SLIDER</td> <td>2.000</td> <td>PC</td> </tr> <tr> <td>VM2268A0</td> <td>DOOR MAGNET COVER</td> <td>2.000</td> <td>PC</td> </tr> <tr> <td>VM2269A0</td> <td>INTERNAL GLASS LOCKING SYSTEM CAP</td> <td>2.000</td> <td>PC</td> </tr> <tr> <td>VM2274A0</td> <td>GROOVED BUSHING</td> <td>1.000</td> <td>PC</td> </tr> <tr> <td>VM2275A0</td> <td>SMOOTH BUSHING</td> <td>1.000</td> <td>PC</td> </tr> <tr> <td>VM2284A0</td> <td>750 SERIES DRIP PROFILE</td> <td>1.000</td> <td>PC</td> </tr> <tr> <td>VM2305A0</td> <td>MM SERIES DOOR CAP FIXING PAWL</td> <td>14.000</td> <td>PC</td> </tr> <tr> <td>VM2312A0</td> <td>MM DRIP PROFILE DRAIN LEFT PIPE</td> <td>1.000</td> <td>PC</td> </tr> <tr> <td>VM2314A0</td> <td>MM DRIP PROFILE CAP</td> <td>1.000</td> <td>PC</td> </tr> <tr> <td>VM2315A0</td> <td>MIND.Maps INTERNAL GLASS CAP SUPPORT</td> <td>3.000</td> <td>PC</td> </tr> <tr> <td>VM2505A0</td> <td>MM PLUS INTERNAL GLASS SUPPORT</td> <td>2.000</td> <td>PC</td> </tr> <tr> <td>VM2518A0</td> <td>BOARD COOLING FAN SUPPORT</td> <td>1.000</td> <td>PC</td> </tr> <tr> <td>VN1179A1</td> <td>CONTROL BOARD 40x40x20mm 12V COOLING FAN</td> <td>1.000</td> <td>PC</td> </tr> <tr> <td>VT1276A0</td> <td>XEVC-0511-E DOOR EXTERNAL GLASS</td> <td>1.000</td> <td>PC</td> </tr> </tbody> </table>	Code	Description	Qty	UOM	VM2267A0	INTERNAL GLASS LOCKING SYSTEM SLIDER	2.000	PC	VM2268A0	DOOR MAGNET COVER	2.000	PC	VM2269A0	INTERNAL GLASS LOCKING SYSTEM CAP	2.000	PC	VM2274A0	GROOVED BUSHING	1.000	PC	VM2275A0	SMOOTH BUSHING	1.000	PC	VM2284A0	750 SERIES DRIP PROFILE	1.000	PC	VM2305A0	MM SERIES DOOR CAP FIXING PAWL	14.000	PC	VM2312A0	MM DRIP PROFILE DRAIN LEFT PIPE	1.000	PC	VM2314A0	MM DRIP PROFILE CAP	1.000	PC	VM2315A0	MIND.Maps INTERNAL GLASS CAP SUPPORT	3.000	PC	VM2505A0	MM PLUS INTERNAL GLASS SUPPORT	2.000	PC	VM2518A0	BOARD COOLING FAN SUPPORT	1.000	PC	VN1179A1	CONTROL BOARD 40x40x20mm 12V COOLING FAN	1.000	PC	VT1276A0	XEVC-0511-E DOOR EXTERNAL GLASS	1.000	PC
Code	Description	Qty	UOM																																																														
VM2267A0	INTERNAL GLASS LOCKING SYSTEM SLIDER	2.000	PC																																																														
VM2268A0	DOOR MAGNET COVER	2.000	PC																																																														
VM2269A0	INTERNAL GLASS LOCKING SYSTEM CAP	2.000	PC																																																														
VM2274A0	GROOVED BUSHING	1.000	PC																																																														
VM2275A0	SMOOTH BUSHING	1.000	PC																																																														
VM2284A0	750 SERIES DRIP PROFILE	1.000	PC																																																														
VM2305A0	MM SERIES DOOR CAP FIXING PAWL	14.000	PC																																																														
VM2312A0	MM DRIP PROFILE DRAIN LEFT PIPE	1.000	PC																																																														
VM2314A0	MM DRIP PROFILE CAP	1.000	PC																																																														
VM2315A0	MIND.Maps INTERNAL GLASS CAP SUPPORT	3.000	PC																																																														
VM2505A0	MM PLUS INTERNAL GLASS SUPPORT	2.000	PC																																																														
VM2518A0	BOARD COOLING FAN SUPPORT	1.000	PC																																																														
VN1179A1	CONTROL BOARD 40x40x20mm 12V COOLING FAN	1.000	PC																																																														
VT1276A0	XEVC-0511-E DOOR EXTERNAL GLASS	1.000	PC																																																														



COMPONENT			SPARE PART																																																																		
Code	Description	Image	Code	Description	Kit components																																																																
OB1108B	XEVC-0511 DOOR EXTERNAL RIGHT COLUMN		KDR1325A	0511 ZERO RIGHT -M EXTERNAL DOOR	<table border="1"> <thead> <tr> <th>Code</th> <th>Description</th> <th>Qty</th> <th>UOM</th> </tr> </thead> <tbody> <tr> <td>OB1106A0</td> <td>XEVC-0511-E DOOR EXTERNAL LEFT COLUMN</td> <td>1.000</td> <td>PC</td> </tr> <tr> <td>OB1107A1</td> <td>XEVC-0511-E LEFT INT DOOR COLUM</td> <td>1.000</td> <td>PC</td> </tr> <tr> <td>OB1108B1</td> <td>XEVC-0511 DOOR EXTERNAL RIGHT COLUM</td> <td>1.000</td> <td>PC</td> </tr> <tr> <td>OB1109A1</td> <td>XEVC-0511-E RIGHT INT DOOR COLUM</td> <td>1.000</td> <td>PC</td> </tr> <tr> <td>OB1122B0</td> <td>MM CT 750mm DOOR LOWER BEAM</td> <td>1.000</td> <td>PC</td> </tr> <tr> <td>OB1166A1</td> <td>XEVC-0511-E EXT GLASS SUPPORT PROFILE</td> <td>2.000</td> <td>PC</td> </tr> <tr> <td>OB1216B0</td> <td>MM DOUBLE GLASS DOOR 750mm UPPER BEAM</td> <td>1.000</td> <td>PC</td> </tr> <tr> <td>OB1217A1</td> <td>MM DOUBLE GLASS DOOR INT UPPER BEAM 750</td> <td>1.000</td> <td>PC</td> </tr> <tr> <td>0H2892A0</td> <td>LED BAR UPPER CAP PLATE</td> <td>1.000</td> <td>PC</td> </tr> <tr> <td>0H2893A0</td> <td>LED BAR LOWER CAP PLATE</td> <td>1.000</td> <td>PC</td> </tr> <tr> <td>CE1096A0</td> <td>4 POLES MICROFIT 3 M BUS CABLE</td> <td>1.000</td> <td>PC</td> </tr> <tr> <td>CE1285A0</td> <td>EMI ROUND FERRITE MOD.26438015 02</td> <td>2.000</td> <td>PC</td> </tr> <tr> <td>CE1851A0</td> <td>MICROFIT CABLE 2P M-F-F AWG22</td> <td>1.000</td> <td>PC</td> </tr> <tr> <td>CE2001A0</td> <td>MICROFIT CABLE 2PM-100-2PM 2AWG22</td> <td>1.000</td> <td>PC</td> </tr> <tr> <td>CE2002A0</td> <td>MICROFIT CABLE 2PM-100-AMP MODU2 2AWG22</td> <td>1.000</td> <td>PC</td> </tr> </tbody> </table>	Code	Description	Qty	UOM	OB1106A0	XEVC-0511-E DOOR EXTERNAL LEFT COLUMN	1.000	PC	OB1107A1	XEVC-0511-E LEFT INT DOOR COLUM	1.000	PC	OB1108B1	XEVC-0511 DOOR EXTERNAL RIGHT COLUM	1.000	PC	OB1109A1	XEVC-0511-E RIGHT INT DOOR COLUM	1.000	PC	OB1122B0	MM CT 750mm DOOR LOWER BEAM	1.000	PC	OB1166A1	XEVC-0511-E EXT GLASS SUPPORT PROFILE	2.000	PC	OB1216B0	MM DOUBLE GLASS DOOR 750mm UPPER BEAM	1.000	PC	OB1217A1	MM DOUBLE GLASS DOOR INT UPPER BEAM 750	1.000	PC	0H2892A0	LED BAR UPPER CAP PLATE	1.000	PC	0H2893A0	LED BAR LOWER CAP PLATE	1.000	PC	CE1096A0	4 POLES MICROFIT 3 M BUS CABLE	1.000	PC	CE1285A0	EMI ROUND FERRITE MOD.26438015 02	2.000	PC	CE1851A0	MICROFIT CABLE 2P M-F-F AWG22	1.000	PC	CE2001A0	MICROFIT CABLE 2PM-100-2PM 2AWG22	1.000	PC	CE2002A0	MICROFIT CABLE 2PM-100-AMP MODU2 2AWG22	1.000	PC
					Code	Description	Qty	UOM																																																													
					OB1106A0	XEVC-0511-E DOOR EXTERNAL LEFT COLUMN	1.000	PC																																																													
					OB1107A1	XEVC-0511-E LEFT INT DOOR COLUM	1.000	PC																																																													
					OB1108B1	XEVC-0511 DOOR EXTERNAL RIGHT COLUM	1.000	PC																																																													
					OB1109A1	XEVC-0511-E RIGHT INT DOOR COLUM	1.000	PC																																																													
					OB1122B0	MM CT 750mm DOOR LOWER BEAM	1.000	PC																																																													
					OB1166A1	XEVC-0511-E EXT GLASS SUPPORT PROFILE	2.000	PC																																																													
					OB1216B0	MM DOUBLE GLASS DOOR 750mm UPPER BEAM	1.000	PC																																																													
					OB1217A1	MM DOUBLE GLASS DOOR INT UPPER BEAM 750	1.000	PC																																																													
					0H2892A0	LED BAR UPPER CAP PLATE	1.000	PC																																																													
					0H2893A0	LED BAR LOWER CAP PLATE	1.000	PC																																																													
					CE1096A0	4 POLES MICROFIT 3 M BUS CABLE	1.000	PC																																																													
					CE1285A0	EMI ROUND FERRITE MOD.26438015 02	2.000	PC																																																													
CE1851A0	MICROFIT CABLE 2P M-F-F AWG22	1.000	PC																																																																		
CE2001A0	MICROFIT CABLE 2PM-100-2PM 2AWG22	1.000	PC																																																																		
CE2002A0	MICROFIT CABLE 2PM-100-AMP MODU2 2AWG22	1.000	PC																																																																		



COMPONENT			SPARE PART																																																																						
Code	Description	Image	Code	Description	Kit components																																																																				
0B1108B	XEVC-0511 DOOR EXTERNAL RIGHT COLUMN		KDR1325A	0511 ZERO RIGHT -M EXTERNAL DOOR	<table border="1"> <thead> <tr> <th>Code</th> <th>Description</th> <th>Qty</th> <th>UOM</th> </tr> </thead> <tbody> <tr> <td>GN1525A0</td> <td>O-RING INT DIAM 9,5 THK 1 NBR 70</td> <td>1.000</td> <td>PC</td> </tr> <tr> <td>LP1019A0</td> <td>6 SERIES L200 LED LIGHT BAR - E415</td> <td>1.000</td> <td>PC</td> </tr> <tr> <td>MG1099A1</td> <td>MM COMPLETE HANDLE</td> <td>1.000</td> <td>PC</td> </tr> <tr> <td>RC1200A0</td> <td>ED=4 WIRE D=0.5 H24 COMPRESSIO N SPRING</td> <td>4.000</td> <td>PC</td> </tr> <tr> <td>SL1170A1</td> <td>S57 BLACK SILICON - 310ml CARTRIDGE</td> <td>30.000</td> <td>ML</td> </tr> <tr> <td>SL1221A0</td> <td>GN1/1 EXTERNAL GLASS UPPER SILICONE</td> <td>1.000</td> <td>PC</td> </tr> <tr> <td>SL1222A0</td> <td>0511 EXTERNAL GLASS LATERAL SILICONE</td> <td>4.000</td> <td>PC</td> </tr> <tr> <td>VE1030A1</td> <td>MAGNET FOR DOOR MICROSWITC H D=22,9mm</td> <td>1.000</td> <td>PC</td> </tr> <tr> <td>VI0239A1</td> <td>SELF-TAPPIN G SCREW 4.2X25 TCB+ INOX</td> <td>4.000</td> <td>PC</td> </tr> <tr> <td>VI1034A0</td> <td>STAINLESS STEEL WASHER 8.4x16x1</td> <td>1.000</td> <td>PC</td> </tr> <tr> <td>VI1074A0</td> <td>4X16 SCREW FOR PLASTIC</td> <td>2.000</td> <td>PC</td> </tr> <tr> <td>VI1103A0</td> <td>40X12 TBSP SCREW FOR PLASTIC</td> <td>2.000</td> <td>PC</td> </tr> <tr> <td>VI1220A1</td> <td>4,2x12 TCB SELF-TAPPIN G SCREW</td> <td>26.000</td> <td>PC</td> </tr> <tr> <td>VI1930A1</td> <td>5x20 ST. STEEL CHIP SCREW</td> <td>16.000</td> <td>PC</td> </tr> <tr> <td>VI1996A0</td> <td>M5x35 SCREW</td> <td>13.000</td> <td>PC</td> </tr> <tr> <td>VI2070A0</td> <td>SHEETTRACS TCB+ 40x8 SELF-THREAD SCREW</td> <td>6.000</td> <td>PC</td> </tr> </tbody> </table>	Code	Description	Qty	UOM	GN1525A0	O-RING INT DIAM 9,5 THK 1 NBR 70	1.000	PC	LP1019A0	6 SERIES L200 LED LIGHT BAR - E415	1.000	PC	MG1099A1	MM COMPLETE HANDLE	1.000	PC	RC1200A0	ED=4 WIRE D=0.5 H24 COMPRESSIO N SPRING	4.000	PC	SL1170A1	S57 BLACK SILICON - 310ml CARTRIDGE	30.000	ML	SL1221A0	GN1/1 EXTERNAL GLASS UPPER SILICONE	1.000	PC	SL1222A0	0511 EXTERNAL GLASS LATERAL SILICONE	4.000	PC	VE1030A1	MAGNET FOR DOOR MICROSWITC H D=22,9mm	1.000	PC	VI0239A1	SELF-TAPPIN G SCREW 4.2X25 TCB+ INOX	4.000	PC	VI1034A0	STAINLESS STEEL WASHER 8.4x16x1	1.000	PC	VI1074A0	4X16 SCREW FOR PLASTIC	2.000	PC	VI1103A0	40X12 TBSP SCREW FOR PLASTIC	2.000	PC	VI1220A1	4,2x12 TCB SELF-TAPPIN G SCREW	26.000	PC	VI1930A1	5x20 ST. STEEL CHIP SCREW	16.000	PC	VI1996A0	M5x35 SCREW	13.000	PC	VI2070A0	SHEETTRACS TCB+ 40x8 SELF-THREAD SCREW	6.000	PC
					Code	Description	Qty	UOM																																																																	
					GN1525A0	O-RING INT DIAM 9,5 THK 1 NBR 70	1.000	PC																																																																	
					LP1019A0	6 SERIES L200 LED LIGHT BAR - E415	1.000	PC																																																																	
					MG1099A1	MM COMPLETE HANDLE	1.000	PC																																																																	
					RC1200A0	ED=4 WIRE D=0.5 H24 COMPRESSIO N SPRING	4.000	PC																																																																	
					SL1170A1	S57 BLACK SILICON - 310ml CARTRIDGE	30.000	ML																																																																	
					SL1221A0	GN1/1 EXTERNAL GLASS UPPER SILICONE	1.000	PC																																																																	
					SL1222A0	0511 EXTERNAL GLASS LATERAL SILICONE	4.000	PC																																																																	
					VE1030A1	MAGNET FOR DOOR MICROSWITC H D=22,9mm	1.000	PC																																																																	
					VI0239A1	SELF-TAPPIN G SCREW 4.2X25 TCB+ INOX	4.000	PC																																																																	
					VI1034A0	STAINLESS STEEL WASHER 8.4x16x1	1.000	PC																																																																	
					VI1074A0	4X16 SCREW FOR PLASTIC	2.000	PC																																																																	
					VI1103A0	40X12 TBSP SCREW FOR PLASTIC	2.000	PC																																																																	
					VI1220A1	4,2x12 TCB SELF-TAPPIN G SCREW	26.000	PC																																																																	
VI1930A1	5x20 ST. STEEL CHIP SCREW	16.000	PC																																																																						
VI1996A0	M5x35 SCREW	13.000	PC																																																																						
VI2070A0	SHEETTRACS TCB+ 40x8 SELF-THREAD SCREW	6.000	PC																																																																						



COMPONENT			SPARE PART																																																																														
Code	Description	Image	Code	Description	Kit components																																																																												
0B1108B	XEVC-0511 DOOR EXTERNAL RIGHT COLUMN		KDR1325A	0511 ZERO RIGHT -M EXTERNAL DOOR	<table border="1"> <thead> <tr> <th>Code</th> <th>Description</th> <th>Qty</th> <th>UOM</th> </tr> </thead> <tbody> <tr> <td>VM1490A0</td> <td>CHEFTOP/BAK ERTOP HANDLE SCREWS COVER</td> <td>2.000</td> <td>PC</td> </tr> <tr> <td>VM1630A1</td> <td>INTERNAL GLASS PUSHING CAP</td> <td>3.000</td> <td>PC</td> </tr> <tr> <td>VM1631A0</td> <td>PLUS INNER GLASS PUSHING CAP</td> <td>3.000</td> <td>PC</td> </tr> <tr> <td>VM2259B0</td> <td>VM2259B0</td> <td>1.000</td> <td>PC</td> </tr> <tr> <td>VM2260B0</td> <td>S6 LEFT UPPER CAP</td> <td>1.000</td> <td>PC</td> </tr> <tr> <td>VM2261B0</td> <td>MM -M DOOR RIGHT LOWER CAP</td> <td>1.000</td> <td>PC</td> </tr> <tr> <td>VM2262B0</td> <td>MM -M DOOR RIGHT UPPER CAP</td> <td>1.000</td> <td>PC</td> </tr> <tr> <td>VM2267A0</td> <td>INTERNAL GLASS LOCKING SYSTEM SLIDER</td> <td>2.000</td> <td>PC</td> </tr> <tr> <td>VM2268A0</td> <td>DOOR MAGNET COVER</td> <td>2.000</td> <td>PC</td> </tr> <tr> <td>VM2269B0</td> <td>INNER GLASS FIXING CAP</td> <td>2.000</td> <td>PC</td> </tr> <tr> <td>VM2274A0</td> <td>GROOVED BUSHING</td> <td>1.000</td> <td>PC</td> </tr> <tr> <td>VM2275A0</td> <td>SMOOTH BUSHING</td> <td>1.000</td> <td>PC</td> </tr> <tr> <td>VM2284B0</td> <td>750 SERIES DRIP PROFILE KIT</td> <td>1.000</td> <td>PC</td> </tr> <tr> <td>VM2305A0</td> <td>MM SERIES DOOR CAP FIXING PAWL</td> <td>14.000</td> <td>PC</td> </tr> <tr> <td>VM2312A0</td> <td>MM DRIP PROFILE DRAIN LEFT PIPE</td> <td>1.000</td> <td>PC</td> </tr> <tr> <td>VM2314A0</td> <td>MM DRIP PROFILE CAP</td> <td>1.000</td> <td>PC</td> </tr> <tr> <td>VM2315B0</td> <td>S6 INTERNAL GLASS SUPPORT</td> <td>3.000</td> <td>PC</td> </tr> <tr> <td>VM2505B1</td> <td>MM PLUS INTERNAL GLASS SUPPORT</td> <td>3.000</td> <td>PC</td> </tr> </tbody> </table>	Code	Description	Qty	UOM	VM1490A0	CHEFTOP/BAK ERTOP HANDLE SCREWS COVER	2.000	PC	VM1630A1	INTERNAL GLASS PUSHING CAP	3.000	PC	VM1631A0	PLUS INNER GLASS PUSHING CAP	3.000	PC	VM2259B0	VM2259B0	1.000	PC	VM2260B0	S6 LEFT UPPER CAP	1.000	PC	VM2261B0	MM -M DOOR RIGHT LOWER CAP	1.000	PC	VM2262B0	MM -M DOOR RIGHT UPPER CAP	1.000	PC	VM2267A0	INTERNAL GLASS LOCKING SYSTEM SLIDER	2.000	PC	VM2268A0	DOOR MAGNET COVER	2.000	PC	VM2269B0	INNER GLASS FIXING CAP	2.000	PC	VM2274A0	GROOVED BUSHING	1.000	PC	VM2275A0	SMOOTH BUSHING	1.000	PC	VM2284B0	750 SERIES DRIP PROFILE KIT	1.000	PC	VM2305A0	MM SERIES DOOR CAP FIXING PAWL	14.000	PC	VM2312A0	MM DRIP PROFILE DRAIN LEFT PIPE	1.000	PC	VM2314A0	MM DRIP PROFILE CAP	1.000	PC	VM2315B0	S6 INTERNAL GLASS SUPPORT	3.000	PC	VM2505B1	MM PLUS INTERNAL GLASS SUPPORT	3.000	PC
					Code	Description	Qty	UOM																																																																									
					VM1490A0	CHEFTOP/BAK ERTOP HANDLE SCREWS COVER	2.000	PC																																																																									
					VM1630A1	INTERNAL GLASS PUSHING CAP	3.000	PC																																																																									
					VM1631A0	PLUS INNER GLASS PUSHING CAP	3.000	PC																																																																									
					VM2259B0	VM2259B0	1.000	PC																																																																									
					VM2260B0	S6 LEFT UPPER CAP	1.000	PC																																																																									
					VM2261B0	MM -M DOOR RIGHT LOWER CAP	1.000	PC																																																																									
					VM2262B0	MM -M DOOR RIGHT UPPER CAP	1.000	PC																																																																									
					VM2267A0	INTERNAL GLASS LOCKING SYSTEM SLIDER	2.000	PC																																																																									
					VM2268A0	DOOR MAGNET COVER	2.000	PC																																																																									
					VM2269B0	INNER GLASS FIXING CAP	2.000	PC																																																																									
					VM2274A0	GROOVED BUSHING	1.000	PC																																																																									
					VM2275A0	SMOOTH BUSHING	1.000	PC																																																																									
					VM2284B0	750 SERIES DRIP PROFILE KIT	1.000	PC																																																																									
					VM2305A0	MM SERIES DOOR CAP FIXING PAWL	14.000	PC																																																																									
					VM2312A0	MM DRIP PROFILE DRAIN LEFT PIPE	1.000	PC																																																																									
					VM2314A0	MM DRIP PROFILE CAP	1.000	PC																																																																									
					VM2315B0	S6 INTERNAL GLASS SUPPORT	3.000	PC																																																																									
					VM2505B1	MM PLUS INTERNAL GLASS SUPPORT	3.000	PC																																																																									



COMPONENT			SPARE PART																																															
Code	Description	Image	Code	Description	Kit components																																													
OB1108B	XEVC-0511 DOOR EXTERNAL RIGHT COLUMN		KDR1325A	0511 ZERO RIGHT -M EXTERNAL DOOR	<table border="1"> <thead> <tr> <th>Code</th> <th>Description</th> <th>Qty</th> <th>UOM</th> </tr> </thead> <tbody> <tr> <td>VP1080A0</td> <td>UPPER HINGE CAP FOR LOWER INNER GLASS</td> <td>1.000</td> <td>PC</td> </tr> <tr> <td>VP1081A0</td> <td>UPPER HINGE CAP FOR UPPER INNER GLASS</td> <td>1.000</td> <td>PC</td> </tr> <tr> <td>VT1276A0</td> <td>XEVC-0511-E DOOR EXTERNAL GLASS</td> <td>1.000</td> <td>PC</td> </tr> </tbody> </table>	Code	Description	Qty	UOM	VP1080A0	UPPER HINGE CAP FOR LOWER INNER GLASS	1.000	PC	VP1081A0	UPPER HINGE CAP FOR UPPER INNER GLASS	1.000	PC	VT1276A0	XEVC-0511-E DOOR EXTERNAL GLASS	1.000	PC																													
			Code	Description	Qty	UOM																																												
VP1080A0	UPPER HINGE CAP FOR LOWER INNER GLASS	1.000	PC																																															
VP1081A0	UPPER HINGE CAP FOR UPPER INNER GLASS	1.000	PC																																															
VT1276A0	XEVC-0511-E DOOR EXTERNAL GLASS	1.000	PC																																															
KDR1269B	BT-04 -M EXTERNAL RIGHT DOOR	<table border="1"> <thead> <tr> <th>Code</th> <th>Description</th> <th>Qty</th> <th>UOM</th> </tr> </thead> <tbody> <tr> <td>OB1107A1</td> <td>XEVC-0511-E LEFT INT DOOR COLUM</td> <td>1.000</td> <td>PC</td> </tr> <tr> <td>OB1108B1</td> <td>XEVC-0511 DOOR EXTERNAL RIGHT COLUM</td> <td>1.000</td> <td>PC</td> </tr> <tr> <td>OB1109A1</td> <td>XEVC-0511-E RIGHT INT DOOR COLUM</td> <td>1.000</td> <td>PC</td> </tr> <tr> <td>OB1126B0</td> <td>860mm DOOR LOWER BEAM</td> <td>1.000</td> <td>PC</td> </tr> <tr> <td>OB1166A1</td> <td>XEVC-0511-E EXT GLASS SUPPORT PROFILE</td> <td>2.000</td> <td>PC</td> </tr> <tr> <td>OB1174A0</td> <td>XEBC-04EU-E LEFT EXT DOOR COLUM</td> <td>1.000</td> <td>PC</td> </tr> <tr> <td>OB1218B0</td> <td>860MM DOUBLE GLASS DOOR UPPER BEAM</td> <td>1.000</td> <td>PC</td> </tr> <tr> <td>OB1219A1</td> <td>MM DOUBLE GLASS DOOR INT UPPER BEAM 860</td> <td>1.000</td> <td>PC</td> </tr> <tr> <td>CE1052A1</td> <td>MM USB-CONTRO L PANEL CONNECTING CABLE</td> <td>1.000</td> <td>PC</td> </tr> <tr> <td>CE1053B0</td> <td>MM MICROFIT LED BAR POWER SUPPLY CABL</td> <td>1.000</td> <td>PC</td> </tr> <tr> <td>CE1097A0</td> <td>4M SIHF 4 POLES MICROFIT CANBUS</td> <td>1.000</td> <td>PC</td> </tr> </tbody> </table>	Code	Description	Qty	UOM	OB1107A1	XEVC-0511-E LEFT INT DOOR COLUM	1.000	PC	OB1108B1	XEVC-0511 DOOR EXTERNAL RIGHT COLUM	1.000	PC	OB1109A1	XEVC-0511-E RIGHT INT DOOR COLUM	1.000	PC	OB1126B0	860mm DOOR LOWER BEAM	1.000	PC	OB1166A1	XEVC-0511-E EXT GLASS SUPPORT PROFILE	2.000	PC	OB1174A0	XEBC-04EU-E LEFT EXT DOOR COLUM	1.000	PC	OB1218B0	860MM DOUBLE GLASS DOOR UPPER BEAM	1.000	PC	OB1219A1	MM DOUBLE GLASS DOOR INT UPPER BEAM 860	1.000	PC	CE1052A1	MM USB-CONTRO L PANEL CONNECTING CABLE	1.000	PC	CE1053B0	MM MICROFIT LED BAR POWER SUPPLY CABL	1.000	PC	CE1097A0	4M SIHF 4 POLES MICROFIT CANBUS	1.000	PC
Code	Description	Qty	UOM																																															
OB1107A1	XEVC-0511-E LEFT INT DOOR COLUM	1.000	PC																																															
OB1108B1	XEVC-0511 DOOR EXTERNAL RIGHT COLUM	1.000	PC																																															
OB1109A1	XEVC-0511-E RIGHT INT DOOR COLUM	1.000	PC																																															
OB1126B0	860mm DOOR LOWER BEAM	1.000	PC																																															
OB1166A1	XEVC-0511-E EXT GLASS SUPPORT PROFILE	2.000	PC																																															
OB1174A0	XEBC-04EU-E LEFT EXT DOOR COLUM	1.000	PC																																															
OB1218B0	860MM DOUBLE GLASS DOOR UPPER BEAM	1.000	PC																																															
OB1219A1	MM DOUBLE GLASS DOOR INT UPPER BEAM 860	1.000	PC																																															
CE1052A1	MM USB-CONTRO L PANEL CONNECTING CABLE	1.000	PC																																															
CE1053B0	MM MICROFIT LED BAR POWER SUPPLY CABL	1.000	PC																																															
CE1097A0	4M SIHF 4 POLES MICROFIT CANBUS	1.000	PC																																															



COMPONENT			SPARE PART																																																																						
Code	Description	Image	Code	Description	Kit components																																																																				
OB1108B	XEVC-0511 DOOR EXTERNAL RIGHT COLUMN		KDR1269B	BT-04 -M EXTERNAL RIGHT DOOR	<table border="1"> <thead> <tr> <th>Code</th> <th>Description</th> <th>Qty</th> <th>UOM</th> </tr> </thead> <tbody> <tr> <td>CE1285A0</td> <td>EMI ROUND FERRITE MOD.26438015 02</td> <td>2.000</td> <td>PC</td> </tr> <tr> <td>LP1019A0</td> <td>6 SERIES L200 LED LIGHT BAR - E415</td> <td>1.000</td> <td>PC</td> </tr> <tr> <td>LP1025A0</td> <td>L=415 LED LIGHT BAR COVER</td> <td>1.000</td> <td>PC</td> </tr> <tr> <td>MG1099A1</td> <td>MM COMPLETE HANDLE</td> <td>1.000</td> <td>PC</td> </tr> <tr> <td>RC1200A0</td> <td>ED=4 WIRE D=0.5 H24 COMPRESSIO N SPRING</td> <td>4.000</td> <td>PC</td> </tr> <tr> <td>SL1170A1</td> <td>S57 BLACK SILICON - 310ml CARTRIDGE</td> <td>35.000</td> <td>ML</td> </tr> <tr> <td>SL1222A0</td> <td>0511 EXTERNAL GLASS LATERAL SILICONE</td> <td>4.000</td> <td>PC</td> </tr> <tr> <td>SL1229A0</td> <td>BAKER EXTERNAL GLASS UPPER SILICONE</td> <td>1.000</td> <td>PC</td> </tr> <tr> <td>VE1030A1</td> <td>MAGNET FOR DOOR MICROSWITC H D=22,9mm</td> <td>1.000</td> <td>PC</td> </tr> <tr> <td>VI0239A1</td> <td>SELF-TAPPIN G SCREW 4.2X25 TCB+ INOX</td> <td>4.000</td> <td>PC</td> </tr> <tr> <td>VI1074A0</td> <td>4X16 SCREW FOR PLASTIC</td> <td>2.000</td> <td>PC</td> </tr> <tr> <td>VI1103A0</td> <td>40X12 TBSP SCREW FOR PLASTIC</td> <td>4.000</td> <td>PC</td> </tr> <tr> <td>VI1220A1</td> <td>4,2x12 TCB SELF-TAPPIN G SCREW</td> <td>28.000</td> <td>PC</td> </tr> <tr> <td>VI1930A1</td> <td>5x20 ST. STEEL CHIP SCREW</td> <td>16.000</td> <td>PC</td> </tr> <tr> <td>VI1996A0</td> <td>M5x35 SCREW</td> <td>13.000</td> <td>PC</td> </tr> <tr> <td>VI2070A0</td> <td>SHEETTRACS TCB+ 40x8 SELF-THREAD SCREW</td> <td>6.000</td> <td>PC</td> </tr> </tbody> </table>	Code	Description	Qty	UOM	CE1285A0	EMI ROUND FERRITE MOD.26438015 02	2.000	PC	LP1019A0	6 SERIES L200 LED LIGHT BAR - E415	1.000	PC	LP1025A0	L=415 LED LIGHT BAR COVER	1.000	PC	MG1099A1	MM COMPLETE HANDLE	1.000	PC	RC1200A0	ED=4 WIRE D=0.5 H24 COMPRESSIO N SPRING	4.000	PC	SL1170A1	S57 BLACK SILICON - 310ml CARTRIDGE	35.000	ML	SL1222A0	0511 EXTERNAL GLASS LATERAL SILICONE	4.000	PC	SL1229A0	BAKER EXTERNAL GLASS UPPER SILICONE	1.000	PC	VE1030A1	MAGNET FOR DOOR MICROSWITC H D=22,9mm	1.000	PC	VI0239A1	SELF-TAPPIN G SCREW 4.2X25 TCB+ INOX	4.000	PC	VI1074A0	4X16 SCREW FOR PLASTIC	2.000	PC	VI1103A0	40X12 TBSP SCREW FOR PLASTIC	4.000	PC	VI1220A1	4,2x12 TCB SELF-TAPPIN G SCREW	28.000	PC	VI1930A1	5x20 ST. STEEL CHIP SCREW	16.000	PC	VI1996A0	M5x35 SCREW	13.000	PC	VI2070A0	SHEETTRACS TCB+ 40x8 SELF-THREAD SCREW	6.000	PC
					Code	Description	Qty	UOM																																																																	
					CE1285A0	EMI ROUND FERRITE MOD.26438015 02	2.000	PC																																																																	
					LP1019A0	6 SERIES L200 LED LIGHT BAR - E415	1.000	PC																																																																	
					LP1025A0	L=415 LED LIGHT BAR COVER	1.000	PC																																																																	
					MG1099A1	MM COMPLETE HANDLE	1.000	PC																																																																	
					RC1200A0	ED=4 WIRE D=0.5 H24 COMPRESSIO N SPRING	4.000	PC																																																																	
					SL1170A1	S57 BLACK SILICON - 310ml CARTRIDGE	35.000	ML																																																																	
					SL1222A0	0511 EXTERNAL GLASS LATERAL SILICONE	4.000	PC																																																																	
					SL1229A0	BAKER EXTERNAL GLASS UPPER SILICONE	1.000	PC																																																																	
					VE1030A1	MAGNET FOR DOOR MICROSWITC H D=22,9mm	1.000	PC																																																																	
					VI0239A1	SELF-TAPPIN G SCREW 4.2X25 TCB+ INOX	4.000	PC																																																																	
					VI1074A0	4X16 SCREW FOR PLASTIC	2.000	PC																																																																	
					VI1103A0	40X12 TBSP SCREW FOR PLASTIC	4.000	PC																																																																	
					VI1220A1	4,2x12 TCB SELF-TAPPIN G SCREW	28.000	PC																																																																	
VI1930A1	5x20 ST. STEEL CHIP SCREW	16.000	PC																																																																						
VI1996A0	M5x35 SCREW	13.000	PC																																																																						
VI2070A0	SHEETTRACS TCB+ 40x8 SELF-THREAD SCREW	6.000	PC																																																																						



COMPONENT			SPARE PART																																																																														
Code	Description	Image	Code	Description	Kit components																																																																												
OB1108B	XEVC-0511 DOOR EXTERNAL RIGHT COLUMN		KDR1269B	BT-04 -M EXTERNAL RIGHT DOOR	<table border="1"> <thead> <tr> <th>Code</th> <th>Description</th> <th>Qty</th> <th>UOM</th> </tr> </thead> <tbody> <tr> <td>VM1490A0</td> <td>CHEFTOP/BAK ERTOP HANDLE SCREWS COVER</td> <td>2.000</td> <td>PC</td> </tr> <tr> <td>VM1630A1</td> <td>INTERNAL GLASS PUSHING CAP</td> <td>3.000</td> <td>PC</td> </tr> <tr> <td>VM1631A0</td> <td>PLUS INNER GLASS PUSHING CAP</td> <td>3.000</td> <td>PC</td> </tr> <tr> <td>VM2259B0</td> <td>VM2259B0</td> <td>1.000</td> <td>PC</td> </tr> <tr> <td>VM2260B0</td> <td>S6 LEFT UPPER CAP</td> <td>1.000</td> <td>PC</td> </tr> <tr> <td>VM2261B0</td> <td>MM -M DOOR RIGHT LOWER CAP</td> <td>1.000</td> <td>PC</td> </tr> <tr> <td>VM2262B0</td> <td>MM -M DOOR RIGHT UPPER CAP</td> <td>1.000</td> <td>PC</td> </tr> <tr> <td>VM2267A0</td> <td>INTERNAL GLASS LOCKING SYSTEM SLIDER</td> <td>2.000</td> <td>PC</td> </tr> <tr> <td>VM2268A0</td> <td>DOOR MAGNET COVER</td> <td>2.000</td> <td>PC</td> </tr> <tr> <td>VM2269B0</td> <td>INNER GLASS FIXING CAP</td> <td>2.000</td> <td>PC</td> </tr> <tr> <td>VM2274A0</td> <td>GROOVED BUSHING</td> <td>1.000</td> <td>PC</td> </tr> <tr> <td>VM2275A0</td> <td>SMOOTH BUSHING</td> <td>1.000</td> <td>PC</td> </tr> <tr> <td>VM2285B0</td> <td>860 SERIES DRIP PROFILE KIT</td> <td>1.000</td> <td>PC</td> </tr> <tr> <td>VM2305A0</td> <td>MM SERIES DOOR CAP FIXING PAWL</td> <td>14.000</td> <td>PC</td> </tr> <tr> <td>VM2312A0</td> <td>MM DRIP PROFILE DRAIN LEFT PIPE</td> <td>1.000</td> <td>PC</td> </tr> <tr> <td>VM2314A0</td> <td>MM DRIP PROFILE CAP</td> <td>1.000</td> <td>PC</td> </tr> <tr> <td>VM2315B0</td> <td>S6 INTERNAL GLASS SUPPORT</td> <td>3.000</td> <td>PC</td> </tr> <tr> <td>VM2505B1</td> <td>MM PLUS INTERNAL GLASS SUPPORT</td> <td>3.000</td> <td>PC</td> </tr> </tbody> </table>	Code	Description	Qty	UOM	VM1490A0	CHEFTOP/BAK ERTOP HANDLE SCREWS COVER	2.000	PC	VM1630A1	INTERNAL GLASS PUSHING CAP	3.000	PC	VM1631A0	PLUS INNER GLASS PUSHING CAP	3.000	PC	VM2259B0	VM2259B0	1.000	PC	VM2260B0	S6 LEFT UPPER CAP	1.000	PC	VM2261B0	MM -M DOOR RIGHT LOWER CAP	1.000	PC	VM2262B0	MM -M DOOR RIGHT UPPER CAP	1.000	PC	VM2267A0	INTERNAL GLASS LOCKING SYSTEM SLIDER	2.000	PC	VM2268A0	DOOR MAGNET COVER	2.000	PC	VM2269B0	INNER GLASS FIXING CAP	2.000	PC	VM2274A0	GROOVED BUSHING	1.000	PC	VM2275A0	SMOOTH BUSHING	1.000	PC	VM2285B0	860 SERIES DRIP PROFILE KIT	1.000	PC	VM2305A0	MM SERIES DOOR CAP FIXING PAWL	14.000	PC	VM2312A0	MM DRIP PROFILE DRAIN LEFT PIPE	1.000	PC	VM2314A0	MM DRIP PROFILE CAP	1.000	PC	VM2315B0	S6 INTERNAL GLASS SUPPORT	3.000	PC	VM2505B1	MM PLUS INTERNAL GLASS SUPPORT	3.000	PC
Code	Description	Qty	UOM																																																																														
VM1490A0	CHEFTOP/BAK ERTOP HANDLE SCREWS COVER	2.000	PC																																																																														
VM1630A1	INTERNAL GLASS PUSHING CAP	3.000	PC																																																																														
VM1631A0	PLUS INNER GLASS PUSHING CAP	3.000	PC																																																																														
VM2259B0	VM2259B0	1.000	PC																																																																														
VM2260B0	S6 LEFT UPPER CAP	1.000	PC																																																																														
VM2261B0	MM -M DOOR RIGHT LOWER CAP	1.000	PC																																																																														
VM2262B0	MM -M DOOR RIGHT UPPER CAP	1.000	PC																																																																														
VM2267A0	INTERNAL GLASS LOCKING SYSTEM SLIDER	2.000	PC																																																																														
VM2268A0	DOOR MAGNET COVER	2.000	PC																																																																														
VM2269B0	INNER GLASS FIXING CAP	2.000	PC																																																																														
VM2274A0	GROOVED BUSHING	1.000	PC																																																																														
VM2275A0	SMOOTH BUSHING	1.000	PC																																																																														
VM2285B0	860 SERIES DRIP PROFILE KIT	1.000	PC																																																																														
VM2305A0	MM SERIES DOOR CAP FIXING PAWL	14.000	PC																																																																														
VM2312A0	MM DRIP PROFILE DRAIN LEFT PIPE	1.000	PC																																																																														
VM2314A0	MM DRIP PROFILE CAP	1.000	PC																																																																														
VM2315B0	S6 INTERNAL GLASS SUPPORT	3.000	PC																																																																														
VM2505B1	MM PLUS INTERNAL GLASS SUPPORT	3.000	PC																																																																														



COMPONENT			SPARE PART																																							
Code	Description	Image	Code	Description	Kit components																																					
0B1108B	XEVC-0511 DOOR EXTERNAL RIGHT COLUMN		KDR1269B	BT-04 -M EXTERNAL RIGHT DOOR	<table border="1"> <thead> <tr> <th>Code</th> <th>Description</th> <th>Qty</th> <th>UOM</th> </tr> </thead> <tbody> <tr> <td>VM2518A0</td> <td>BOARD COOLING FAN SUPPORT</td> <td>1.000</td> <td>PC</td> </tr> <tr> <td>VN1179A1</td> <td>CONTROL BOARD 40x40x20mm 12V COOLING FAN</td> <td>1.000</td> <td>PC</td> </tr> <tr> <td>VP1080A0</td> <td>UPPER HINGE CAP FOR LOWER INNER GLASS</td> <td>1.000</td> <td>PC</td> </tr> <tr> <td>VP1081A0</td> <td>UPPER HINGE CAP FOR UPPER INNER GLASS</td> <td>1.000</td> <td>PC</td> </tr> <tr> <td>VT1290A0</td> <td>EXTERNAL GLASS XEBC-04EU-E</td> <td>1.000</td> <td>PC</td> </tr> </tbody> </table>	Code	Description	Qty	UOM	VM2518A0	BOARD COOLING FAN SUPPORT	1.000	PC	VN1179A1	CONTROL BOARD 40x40x20mm 12V COOLING FAN	1.000	PC	VP1080A0	UPPER HINGE CAP FOR LOWER INNER GLASS	1.000	PC	VP1081A0	UPPER HINGE CAP FOR UPPER INNER GLASS	1.000	PC	VT1290A0	EXTERNAL GLASS XEBC-04EU-E	1.000	PC													
			Code	Description	Qty	UOM																																				
VM2518A0	BOARD COOLING FAN SUPPORT	1.000	PC																																							
VN1179A1	CONTROL BOARD 40x40x20mm 12V COOLING FAN	1.000	PC																																							
VP1080A0	UPPER HINGE CAP FOR LOWER INNER GLASS	1.000	PC																																							
VP1081A0	UPPER HINGE CAP FOR UPPER INNER GLASS	1.000	PC																																							
VT1290A0	EXTERNAL GLASS XEBC-04EU-E	1.000	PC																																							
KDR1269A	BT-04 EXTERNAL RIGHT DOOR	<table border="1"> <thead> <tr> <th>Code</th> <th>Description</th> <th>Qty</th> <th>UOM</th> </tr> </thead> <tbody> <tr> <td>0B1107A1</td> <td>XEVC-0511-E LEFT INT DOOR COLUM</td> <td>1.000</td> <td>PC</td> </tr> <tr> <td>0B1108B1</td> <td>XEVC-0511 DOOR EXTERNAL RIGHT COLUM</td> <td>1.000</td> <td>PC</td> </tr> <tr> <td>0B1109A1</td> <td>XEVC-0511-E RIGHT INT DOOR COLUM</td> <td>1.000</td> <td>PC</td> </tr> <tr> <td>0B1126A1</td> <td>860mm DOOR LOWER FRAME SHAPE</td> <td>1.000</td> <td>PC</td> </tr> <tr> <td>0B1166A1</td> <td>XEVC-0511-E EXT GLASS SUPPORT PROFILE</td> <td>2.000</td> <td>PC</td> </tr> <tr> <td>0B1174A0</td> <td>XEBC-04EU-E LEFT EXT DOOR COLUM</td> <td>1.000</td> <td>PC</td> </tr> <tr> <td>0B1218A1</td> <td>860MM DOUBLE GLASS DOOR UPPER BEAM</td> <td>1.000</td> <td>PC</td> </tr> <tr> <td>0B1219A1</td> <td>MM DOUBLE GLASS DOOR INT UPPER BEAM 860</td> <td>1.000</td> <td>PC</td> </tr> <tr> <td>CE1052A1</td> <td>MM USB-CONTRO L PANEL CONNECTING CABLE</td> <td>1.000</td> <td>PC</td> </tr> </tbody> </table>	Code	Description	Qty	UOM	0B1107A1	XEVC-0511-E LEFT INT DOOR COLUM	1.000	PC	0B1108B1	XEVC-0511 DOOR EXTERNAL RIGHT COLUM	1.000	PC	0B1109A1	XEVC-0511-E RIGHT INT DOOR COLUM	1.000	PC	0B1126A1	860mm DOOR LOWER FRAME SHAPE	1.000	PC	0B1166A1	XEVC-0511-E EXT GLASS SUPPORT PROFILE	2.000	PC	0B1174A0	XEBC-04EU-E LEFT EXT DOOR COLUM	1.000	PC	0B1218A1	860MM DOUBLE GLASS DOOR UPPER BEAM	1.000	PC	0B1219A1	MM DOUBLE GLASS DOOR INT UPPER BEAM 860	1.000	PC	CE1052A1	MM USB-CONTRO L PANEL CONNECTING CABLE	1.000	PC
Code	Description	Qty	UOM																																							
0B1107A1	XEVC-0511-E LEFT INT DOOR COLUM	1.000	PC																																							
0B1108B1	XEVC-0511 DOOR EXTERNAL RIGHT COLUM	1.000	PC																																							
0B1109A1	XEVC-0511-E RIGHT INT DOOR COLUM	1.000	PC																																							
0B1126A1	860mm DOOR LOWER FRAME SHAPE	1.000	PC																																							
0B1166A1	XEVC-0511-E EXT GLASS SUPPORT PROFILE	2.000	PC																																							
0B1174A0	XEBC-04EU-E LEFT EXT DOOR COLUM	1.000	PC																																							
0B1218A1	860MM DOUBLE GLASS DOOR UPPER BEAM	1.000	PC																																							
0B1219A1	MM DOUBLE GLASS DOOR INT UPPER BEAM 860	1.000	PC																																							
CE1052A1	MM USB-CONTRO L PANEL CONNECTING CABLE	1.000	PC																																							



COMPONENT			SPARE PART					
Code	Description	Image	Code	Description	Kit components			
OB1108B	XEVC-0511 DOOR EXTERNAL RIGHT COLUMN		KDR1269A	BT-04 EXTERNAL RIGHT DOOR	Code	Description	Qty	UOM
					CE1053B0	MM MICROFIT LED BAR POWER SUPPLY CABL	1.000	PC
					CE1285A0	EMI ROUND FERRITE MOD.26438015 02	1.000	PC
					CE1290A0	EXTRACTABL E FEMALE TERMINAL CPF 5/4	1.000	PC
					CE1310A1	POWER - CONTROL BOARD CONNECTING CABLE	1.000	PC
					LP1019A0	6 SERIES L200 LED LIGHT BAR - E415	1.000	PC
					LP1025A0	L=415 LED LIGHT BAR COVER	1.000	PC
					MG1083A2	MM COMPLETE HANDLE	1.000	PC
					SL1170A1	S57 BLACK SILICON - 310ml CARTRIDGE	30.000	ML
					VE1030A1	MAGNET FOR DOOR MICROSWITC H D=22,9mm	1.000	PC
					VH1147A0	5X25 STAINLESS STEEL SCREW	16.000	PC
					VH1220A1	4,2x12 TCB SELF-TAPPIN G SCREW	25.000	PC
					VH1996A0	M5x35 SCREW	13.000	PC
					VM1630A1	INTERNAL GLASS PUSHING CAP	3.000	PC
					VM1631A0	PLUS INNER GLASS PUSHING CAP	2.000	PC
					VM2259A1	6 SERIES DOOR LOWER LEFT CAP	1.000	PC
					VM2260A1	6 SERIES DOOR UPPER LEFT CAP	1.000	PC



COMPONENT			SPARE PART					
Code	Description	Image	Code	Description	Kit components			
OB1108B	XEVC-0511 DOOR EXTERNAL RIGHT COLUMN		KDR1269A	BT-04 EXTERNAL RIGHT DOOR	Code	Description	Qty	UOM
					VM2261A1	MM DOOR LOWER RIGHT CAP	1.000	PC
					VM2262A1	MM DOOR UPPER RIGHT CAP	1.000	PC
					VM2267A0	INTERNAL GLASS LOCKING SYSTEM SLIDER	2.000	PC
					VM2268A0	DOOR MAGNET COVER	2.000	PC
					VM2269A0	INTERNAL GLASS LOCKING SYSTEM CAP	2.000	PC
					VM2274A0	GROOVED BUSHING	1.000	PC
					VM2275A0	SMOOTH BUSHING	1.000	PC
					VM2285A0	860 SERIES DRIP PROFILE	1.000	PC
					VM2305A0	MM SERIES DOOR CAP FIXING PAWL	14.000	PC
					VM2312A0	MM DRIP PROFILE DRAIN LEFT PIPE	1.000	PC
					VM2313A0	MM DRIP TRAY RIGHT DRAIN PIPE	1.000	PC
					VM2314A0	MM DRIP PROFILE CAP	1.000	PC
					VM2315A0	MIND.Maps INTERNAL GLASS CAP SUPPORT	3.000	PC
					VM2505A0	MM PLUS INTERNAL GLASS SUPPORT	2.000	PC
					VM2518A0	BOARD COOLING FAN SUPPORT	1.000	PC
					VN1179A1	CONTROL BOARD 40x40x20mm 12V COOLING FAN	1.000	PC
VT1290A0	EXTERNAL GLASS XEBC-04EU-E	1.000	PC					



COMPONENT			SPARE PART																																																																		
Code	Description	Image	Code	Description	Kit components																																																																
OB1108B	XEVC-0511 DOOR EXTERNAL RIGHT COLUMN		KDR1261B	0511 -M RIGHT EXTERNAL DOOR	<table border="1"> <thead> <tr> <th>Code</th> <th>Description</th> <th>Qty</th> <th>UOM</th> </tr> </thead> <tbody> <tr> <td>OB1106A0</td> <td>XEVC-0511-E DOOR EXTERNAL LEFT COLUMN</td> <td>1.000</td> <td>PC</td> </tr> <tr> <td>OB1107A1</td> <td>XEVC-0511-E LEFT INT DOOR COLUM</td> <td>1.000</td> <td>PC</td> </tr> <tr> <td>OB1108B1</td> <td>XEVC-0511 DOOR EXTERNAL RIGHT COLUM</td> <td>1.000</td> <td>PC</td> </tr> <tr> <td>OB1109A1</td> <td>XEVC-0511-E RIGHT INT DOOR COLUM</td> <td>1.000</td> <td>PC</td> </tr> <tr> <td>OB1122B0</td> <td>MM CT 750mm DOOR LOWER BEAM</td> <td>1.000</td> <td>PC</td> </tr> <tr> <td>OB1166A1</td> <td>XEVC-0511-E EXT GLASS SUPPORT PROFILE</td> <td>2.000</td> <td>PC</td> </tr> <tr> <td>OB1216B0</td> <td>MM DOUBLE GLASS DOOR 750mm UPPER BEAM</td> <td>1.000</td> <td>PC</td> </tr> <tr> <td>OB1217A1</td> <td>MM DOUBLE GLASS DOOR INT UPPER BEAM 750</td> <td>1.000</td> <td>PC</td> </tr> <tr> <td>CE1052A1</td> <td>MM USB-CONTRO L PANEL CONNECTING CABLE</td> <td>1.000</td> <td>PC</td> </tr> <tr> <td>CE1053B0</td> <td>MM MICROFIT LED BAR POWER SUPPLY CABL</td> <td>1.000</td> <td>PC</td> </tr> <tr> <td>CE1096A0</td> <td>4 POLES MICROFIT 3 M BUS CABLE</td> <td>1.000</td> <td>PC</td> </tr> <tr> <td>CE1285A0</td> <td>EMI ROUND FERRITE MOD.26438015 02</td> <td>2.000</td> <td>PC</td> </tr> <tr> <td>GN1525A0</td> <td>O-RING INT DIAM 9,5 THK 1 NBR 70</td> <td>1.000</td> <td>PC</td> </tr> <tr> <td>LP1019A0</td> <td>6 SERIES L200 LED LIGHT BAR - E415</td> <td>1.000</td> <td>PC</td> </tr> <tr> <td>LP1025A0</td> <td>L=415 LED LIGHT BAR COVER</td> <td>1.000</td> <td>PC</td> </tr> </tbody> </table>	Code	Description	Qty	UOM	OB1106A0	XEVC-0511-E DOOR EXTERNAL LEFT COLUMN	1.000	PC	OB1107A1	XEVC-0511-E LEFT INT DOOR COLUM	1.000	PC	OB1108B1	XEVC-0511 DOOR EXTERNAL RIGHT COLUM	1.000	PC	OB1109A1	XEVC-0511-E RIGHT INT DOOR COLUM	1.000	PC	OB1122B0	MM CT 750mm DOOR LOWER BEAM	1.000	PC	OB1166A1	XEVC-0511-E EXT GLASS SUPPORT PROFILE	2.000	PC	OB1216B0	MM DOUBLE GLASS DOOR 750mm UPPER BEAM	1.000	PC	OB1217A1	MM DOUBLE GLASS DOOR INT UPPER BEAM 750	1.000	PC	CE1052A1	MM USB-CONTRO L PANEL CONNECTING CABLE	1.000	PC	CE1053B0	MM MICROFIT LED BAR POWER SUPPLY CABL	1.000	PC	CE1096A0	4 POLES MICROFIT 3 M BUS CABLE	1.000	PC	CE1285A0	EMI ROUND FERRITE MOD.26438015 02	2.000	PC	GN1525A0	O-RING INT DIAM 9,5 THK 1 NBR 70	1.000	PC	LP1019A0	6 SERIES L200 LED LIGHT BAR - E415	1.000	PC	LP1025A0	L=415 LED LIGHT BAR COVER	1.000	PC
					Code	Description	Qty	UOM																																																													
					OB1106A0	XEVC-0511-E DOOR EXTERNAL LEFT COLUMN	1.000	PC																																																													
					OB1107A1	XEVC-0511-E LEFT INT DOOR COLUM	1.000	PC																																																													
					OB1108B1	XEVC-0511 DOOR EXTERNAL RIGHT COLUM	1.000	PC																																																													
					OB1109A1	XEVC-0511-E RIGHT INT DOOR COLUM	1.000	PC																																																													
					OB1122B0	MM CT 750mm DOOR LOWER BEAM	1.000	PC																																																													
					OB1166A1	XEVC-0511-E EXT GLASS SUPPORT PROFILE	2.000	PC																																																													
					OB1216B0	MM DOUBLE GLASS DOOR 750mm UPPER BEAM	1.000	PC																																																													
					OB1217A1	MM DOUBLE GLASS DOOR INT UPPER BEAM 750	1.000	PC																																																													
					CE1052A1	MM USB-CONTRO L PANEL CONNECTING CABLE	1.000	PC																																																													
					CE1053B0	MM MICROFIT LED BAR POWER SUPPLY CABL	1.000	PC																																																													
					CE1096A0	4 POLES MICROFIT 3 M BUS CABLE	1.000	PC																																																													
					CE1285A0	EMI ROUND FERRITE MOD.26438015 02	2.000	PC																																																													
					GN1525A0	O-RING INT DIAM 9,5 THK 1 NBR 70	1.000	PC																																																													
LP1019A0	6 SERIES L200 LED LIGHT BAR - E415	1.000	PC																																																																		
LP1025A0	L=415 LED LIGHT BAR COVER	1.000	PC																																																																		



COMPONENT			SPARE PART					
Code	Description	Image	Code	Description	Kit components			
OB1108B	XEVC-0511 DOOR EXTERNAL RIGHT COLUMN		KDR1261B	0511 -M RIGHT EXTERNAL DOOR	Code	Description	Qty	UOM
					MG1099A1	MM COMPLETE HANDLE	1.000	PC
					RC1200A0	ED=4 WIRE D=0.5 H24 COMPRESSIO N SPRING	4.000	PC
					SL1170A1	S57 BLACK SILICON - 310ml CARTRIDGE	30.000	ML
					SL1221A0	GN1/1 EXTERNAL GLASS UPPER SILICONE	1.000	PC
					SL1222A0	0511 EXTERNAL GLASS LATERAL SILICONE	4.000	PC
					VE1030A1	MAGNET FOR DOOR MICROSWITC H D=22,9mm	1.000	PC
					VI0239A1	SELF-TAPPIN G SCREW 4,2X25 TCB+ INOX	4.000	PC
					VI1034A0	STAINLESS STEEL WASHER 8,4x16x1	1.000	PC
					VI1074A0	4X16 SCREW FOR PLASTIC	2.000	PC
					VI1103A0	40X12 TBSP SCREW FOR PLASTIC	2.000	PC
					VI1220A1	4,2x12 TCB SELF-TAPPIN G SCREW	26.000	PC
					VI1930A1	5x20 ST. STEEL CHIP SCREW	16.000	PC
					VI1996A0	M5x35 SCREW	13.000	PC
					VI2070A0	SHEETTRACS TCB+ 40x8 SELF-THREAD SCREW	6.000	PC
VM1490A0	CHEFTOP/BAK ERTOP HANDLE SCREWS COVER	2.000	PC					



COMPONENT			SPARE PART																																																																															
Code	Description	Image	Code	Description	Kit components																																																																													
OB1108B	XEVC-0511 DOOR EXTERNAL RIGHT COLUMN		KDR1261B	0511 -M RIGHT EXTERNAL DOOR	<table border="1"> <thead> <tr> <th>Code</th> <th>Description</th> <th>Qty</th> <th>UOM</th> </tr> </thead> <tbody> <tr> <td>VM1630A1</td> <td>INTERNAL GLASS PUSHING CAP</td> <td>3.000</td> <td>PC</td> </tr> <tr> <td>VM1631A0</td> <td>PLUS INNER GLASS PUSHING CAP</td> <td>3.000</td> <td>PC</td> </tr> <tr> <td>VM2259B0</td> <td>VM2259B0</td> <td>1.000</td> <td>PC</td> </tr> <tr> <td>VM2260B0</td> <td>S6 LEFT UPPER CAP</td> <td>1.000</td> <td>PC</td> </tr> <tr> <td>VM2261B0</td> <td>MM -M DOOR RIGHT LOWER CAP</td> <td>1.000</td> <td>PC</td> </tr> <tr> <td>VM2262B0</td> <td>MM -M DOOR RIGHT UPPER CAP</td> <td>1.000</td> <td>PC</td> </tr> <tr> <td>VM2267A0</td> <td>INTERNAL GLASS LOCKING SYSTEM SLIDER</td> <td>2.000</td> <td>PC</td> </tr> <tr> <td>VM2268A0</td> <td>DOOR MAGNET COVER</td> <td>2.000</td> <td>PC</td> </tr> <tr> <td>VM2269B0</td> <td>INNER GLASS FIXING CAP</td> <td>2.000</td> <td>PC</td> </tr> <tr> <td>VM2274A0</td> <td>GROOVED BUSHING</td> <td>1.000</td> <td>PC</td> </tr> <tr> <td>VM2275A0</td> <td>SMOOTH BUSHING</td> <td>1.000</td> <td>PC</td> </tr> <tr> <td>VM2284B0</td> <td>750 SERIES DRIP PROFILE KIT</td> <td>1.000</td> <td>PC</td> </tr> <tr> <td>VM2305A0</td> <td>MM SERIES DOOR CAP FIXING PAWL</td> <td>14.000</td> <td>PC</td> </tr> <tr> <td>VM2312A0</td> <td>MM DRIP PROFILE DRAIN LEFT PIPE</td> <td>1.000</td> <td>PC</td> </tr> <tr> <td>VM2314A0</td> <td>MM DRIP PROFILE CAP</td> <td>1.000</td> <td>PC</td> </tr> <tr> <td>VM2315B0</td> <td>S6 INTERNAL GLASS SUPPORT</td> <td>3.000</td> <td>PC</td> </tr> <tr> <td>VM2505B1</td> <td>MM PLUS INTERNAL GLASS SUPPORT</td> <td>3.000</td> <td>PC</td> </tr> <tr> <td>VP1080A0</td> <td>UPPER HINGE CAP FOR LOWER INNER GLASS</td> <td>1.000</td> <td>PC</td> </tr> </tbody> </table>	Code	Description	Qty	UOM	VM1630A1	INTERNAL GLASS PUSHING CAP	3.000	PC	VM1631A0	PLUS INNER GLASS PUSHING CAP	3.000	PC	VM2259B0	VM2259B0	1.000	PC	VM2260B0	S6 LEFT UPPER CAP	1.000	PC	VM2261B0	MM -M DOOR RIGHT LOWER CAP	1.000	PC	VM2262B0	MM -M DOOR RIGHT UPPER CAP	1.000	PC	VM2267A0	INTERNAL GLASS LOCKING SYSTEM SLIDER	2.000	PC	VM2268A0	DOOR MAGNET COVER	2.000	PC	VM2269B0	INNER GLASS FIXING CAP	2.000	PC	VM2274A0	GROOVED BUSHING	1.000	PC	VM2275A0	SMOOTH BUSHING	1.000	PC	VM2284B0	750 SERIES DRIP PROFILE KIT	1.000	PC	VM2305A0	MM SERIES DOOR CAP FIXING PAWL	14.000	PC	VM2312A0	MM DRIP PROFILE DRAIN LEFT PIPE	1.000	PC	VM2314A0	MM DRIP PROFILE CAP	1.000	PC	VM2315B0	S6 INTERNAL GLASS SUPPORT	3.000	PC	VM2505B1	MM PLUS INTERNAL GLASS SUPPORT	3.000	PC	VP1080A0	UPPER HINGE CAP FOR LOWER INNER GLASS	1.000	PC	
Code	Description	Qty	UOM																																																																															
VM1630A1	INTERNAL GLASS PUSHING CAP	3.000	PC																																																																															
VM1631A0	PLUS INNER GLASS PUSHING CAP	3.000	PC																																																																															
VM2259B0	VM2259B0	1.000	PC																																																																															
VM2260B0	S6 LEFT UPPER CAP	1.000	PC																																																																															
VM2261B0	MM -M DOOR RIGHT LOWER CAP	1.000	PC																																																																															
VM2262B0	MM -M DOOR RIGHT UPPER CAP	1.000	PC																																																																															
VM2267A0	INTERNAL GLASS LOCKING SYSTEM SLIDER	2.000	PC																																																																															
VM2268A0	DOOR MAGNET COVER	2.000	PC																																																																															
VM2269B0	INNER GLASS FIXING CAP	2.000	PC																																																																															
VM2274A0	GROOVED BUSHING	1.000	PC																																																																															
VM2275A0	SMOOTH BUSHING	1.000	PC																																																																															
VM2284B0	750 SERIES DRIP PROFILE KIT	1.000	PC																																																																															
VM2305A0	MM SERIES DOOR CAP FIXING PAWL	14.000	PC																																																																															
VM2312A0	MM DRIP PROFILE DRAIN LEFT PIPE	1.000	PC																																																																															
VM2314A0	MM DRIP PROFILE CAP	1.000	PC																																																																															
VM2315B0	S6 INTERNAL GLASS SUPPORT	3.000	PC																																																																															
VM2505B1	MM PLUS INTERNAL GLASS SUPPORT	3.000	PC																																																																															
VP1080A0	UPPER HINGE CAP FOR LOWER INNER GLASS	1.000	PC																																																																															



COMPONENT			SPARE PART																																																			
Code	Description	Image	Code	Description	Kit components																																																	
0B1108B	XEVC-0511 DOOR EXTERNAL RIGHT COLUMN		KDR1261B	0511 -M RIGHT EXTERNAL DOOR	<table border="1"> <thead> <tr> <th>Code</th> <th>Description</th> <th>Qty</th> <th>UOM</th> </tr> </thead> <tbody> <tr> <td>VP1081A0</td> <td>UPPER HINGE CAP FOR UPPER INNER GLASS</td> <td>1.000</td> <td>PC</td> </tr> <tr> <td>VT1276A0</td> <td>XEVC-0511-E DOOR EXTERNAL GLASS</td> <td>1.000</td> <td>PC</td> </tr> </tbody> </table>	Code	Description	Qty	UOM	VP1081A0	UPPER HINGE CAP FOR UPPER INNER GLASS	1.000	PC	VT1276A0	XEVC-0511-E DOOR EXTERNAL GLASS	1.000	PC																																					
			Code	Description	Qty	UOM																																																
VP1081A0	UPPER HINGE CAP FOR UPPER INNER GLASS	1.000	PC																																																			
VT1276A0	XEVC-0511-E DOOR EXTERNAL GLASS	1.000	PC																																																			
KDR1261A	0511 RIGHT EXTERNAL DOOR	<table border="1"> <thead> <tr> <th>Code</th> <th>Description</th> <th>Qty</th> <th>UOM</th> </tr> </thead> <tbody> <tr> <td>0B1106A0</td> <td>XEVC-0511-E DOOR EXTERNAL LEFT COLUMN</td> <td>1.000</td> <td>PC</td> </tr> <tr> <td>0B1107A1</td> <td>XEVC-0511-E LEFT INT DOOR COLUM</td> <td>1.000</td> <td>PC</td> </tr> <tr> <td>0B1108B1</td> <td>XEVC-0511 DOOR EXTERNAL RIGHT COLUM</td> <td>1.000</td> <td>PC</td> </tr> <tr> <td>0B1109A1</td> <td>XEVC-0511-E RIGHT INT DOOR COLUM</td> <td>1.000</td> <td>PC</td> </tr> <tr> <td>0B1122A1</td> <td>750MM DOOR LOWER FRAME SHAPE</td> <td>1.000</td> <td>PC</td> </tr> <tr> <td>0B1166A1</td> <td>XEVC-0511-E EXT GLASS SUPPORT PROFILE</td> <td>2.000</td> <td>PC</td> </tr> <tr> <td>0B1216A1</td> <td>MM CT DOUBLE GLASS DOOR UPPER BEAM</td> <td>1.000</td> <td>PC</td> </tr> <tr> <td>0B1217A1</td> <td>MM DOUBLE GLASS DOOR INT UPPER BEAM 750</td> <td>1.000</td> <td>PC</td> </tr> <tr> <td>CE1052A1</td> <td>MM USB-CONTRO L PANEL CONNECTING CABLE</td> <td>1.000</td> <td>PC</td> </tr> <tr> <td>CE1053B0</td> <td>MM MICROFIT LED BAR POWER SUPPLY CABL</td> <td>1.000</td> <td>PC</td> </tr> <tr> <td>CE1275A0</td> <td>3M POWER - CONTROL CONNECTION CABLE</td> <td>1.000</td> <td>PC</td> </tr> <tr> <td>CE1285A0</td> <td>EMI ROUND FERRITE MOD.26438015 02</td> <td>1.000</td> <td>PC</td> </tr> </tbody> </table>	Code	Description	Qty	UOM	0B1106A0	XEVC-0511-E DOOR EXTERNAL LEFT COLUMN	1.000	PC	0B1107A1	XEVC-0511-E LEFT INT DOOR COLUM	1.000	PC	0B1108B1	XEVC-0511 DOOR EXTERNAL RIGHT COLUM	1.000	PC	0B1109A1	XEVC-0511-E RIGHT INT DOOR COLUM	1.000	PC	0B1122A1	750MM DOOR LOWER FRAME SHAPE	1.000	PC	0B1166A1	XEVC-0511-E EXT GLASS SUPPORT PROFILE	2.000	PC	0B1216A1	MM CT DOUBLE GLASS DOOR UPPER BEAM	1.000	PC	0B1217A1	MM DOUBLE GLASS DOOR INT UPPER BEAM 750	1.000	PC	CE1052A1	MM USB-CONTRO L PANEL CONNECTING CABLE	1.000	PC	CE1053B0	MM MICROFIT LED BAR POWER SUPPLY CABL	1.000	PC	CE1275A0	3M POWER - CONTROL CONNECTION CABLE	1.000	PC	CE1285A0	EMI ROUND FERRITE MOD.26438015 02	1.000	PC
Code	Description	Qty	UOM																																																			
0B1106A0	XEVC-0511-E DOOR EXTERNAL LEFT COLUMN	1.000	PC																																																			
0B1107A1	XEVC-0511-E LEFT INT DOOR COLUM	1.000	PC																																																			
0B1108B1	XEVC-0511 DOOR EXTERNAL RIGHT COLUM	1.000	PC																																																			
0B1109A1	XEVC-0511-E RIGHT INT DOOR COLUM	1.000	PC																																																			
0B1122A1	750MM DOOR LOWER FRAME SHAPE	1.000	PC																																																			
0B1166A1	XEVC-0511-E EXT GLASS SUPPORT PROFILE	2.000	PC																																																			
0B1216A1	MM CT DOUBLE GLASS DOOR UPPER BEAM	1.000	PC																																																			
0B1217A1	MM DOUBLE GLASS DOOR INT UPPER BEAM 750	1.000	PC																																																			
CE1052A1	MM USB-CONTRO L PANEL CONNECTING CABLE	1.000	PC																																																			
CE1053B0	MM MICROFIT LED BAR POWER SUPPLY CABL	1.000	PC																																																			
CE1275A0	3M POWER - CONTROL CONNECTION CABLE	1.000	PC																																																			
CE1285A0	EMI ROUND FERRITE MOD.26438015 02	1.000	PC																																																			



COMPONENT			SPARE PART																																																																										
Code	Description	Image	Code	Description	Kit components																																																																								
OB1108B	XEVC-0511 DOOR EXTERNAL RIGHT COLUMN		KDR1261A	0511 RIGHT EXTERNAL DOOR	<table border="1"> <thead> <tr> <th>Code</th> <th>Description</th> <th>Qty</th> <th>UOM</th> </tr> </thead> <tbody> <tr> <td>CE1290A0</td> <td>EXTRACTABL E FEMALE TERMINAL CPF 5/4</td> <td>1.000</td> <td>PC</td> </tr> <tr> <td>GN1525A0</td> <td>O-RING INT DIAM 9,5 THK 1 NBR 70</td> <td>1.000</td> <td>PC</td> </tr> <tr> <td>LP1019A0</td> <td>6 SERIES L200 LED LIGHT BAR - E415</td> <td>1.000</td> <td>PC</td> </tr> <tr> <td>LP1025A0</td> <td>L=415 LED LIGHT BAR COVER</td> <td>1.000</td> <td>PC</td> </tr> <tr> <td>MG1083A2</td> <td>MM COMPLETE HANDLE</td> <td>1.000</td> <td>PC</td> </tr> <tr> <td>SL1170A1</td> <td>S57 BLACK SILICON - 310ml CARTRIDGE</td> <td>30.000</td> <td>ML</td> </tr> <tr> <td>VE1030A1</td> <td>MAGNET FOR DOOR MICROSWITC H D=22,9mm</td> <td>1.000</td> <td>PC</td> </tr> <tr> <td>VI1034A0</td> <td>STAINLESS STEEL WASHER 8,4x16x1</td> <td>1.000</td> <td>PC</td> </tr> <tr> <td>VI1147A0</td> <td>5X25 STAINLESS STEEL SCREW</td> <td>16.000</td> <td>PC</td> </tr> <tr> <td>VI1220A1</td> <td>4,2x12 TCB SELF-TAPPIN G SCREW</td> <td>25.000</td> <td>PC</td> </tr> <tr> <td>VI1996A0</td> <td>M5x35 SCREW</td> <td>13.000</td> <td>PC</td> </tr> <tr> <td>VM1630A1</td> <td>INTERNAL GLASS PUSHING CAP</td> <td>3.000</td> <td>PC</td> </tr> <tr> <td>VM1631A0</td> <td>PLUS INNER GLASS PUSHING CAP</td> <td>2.000</td> <td>PC</td> </tr> <tr> <td>VM2259A1</td> <td>6 SERIES DOOR LOWER LEFT CAP</td> <td>1.000</td> <td>PC</td> </tr> <tr> <td>VM2260A1</td> <td>6 SERIES DOOR UPPER LEFT CAP</td> <td>1.000</td> <td>PC</td> </tr> <tr> <td>VM2261A1</td> <td>MM DOOR LOWER RIGHT CAP</td> <td>1.000</td> <td>PC</td> </tr> <tr> <td>VM2262A1</td> <td>MM DOOR UPPER RIGHT CAP</td> <td>1.000</td> <td>PC</td> </tr> </tbody> </table>	Code	Description	Qty	UOM	CE1290A0	EXTRACTABL E FEMALE TERMINAL CPF 5/4	1.000	PC	GN1525A0	O-RING INT DIAM 9,5 THK 1 NBR 70	1.000	PC	LP1019A0	6 SERIES L200 LED LIGHT BAR - E415	1.000	PC	LP1025A0	L=415 LED LIGHT BAR COVER	1.000	PC	MG1083A2	MM COMPLETE HANDLE	1.000	PC	SL1170A1	S57 BLACK SILICON - 310ml CARTRIDGE	30.000	ML	VE1030A1	MAGNET FOR DOOR MICROSWITC H D=22,9mm	1.000	PC	VI1034A0	STAINLESS STEEL WASHER 8,4x16x1	1.000	PC	VI1147A0	5X25 STAINLESS STEEL SCREW	16.000	PC	VI1220A1	4,2x12 TCB SELF-TAPPIN G SCREW	25.000	PC	VI1996A0	M5x35 SCREW	13.000	PC	VM1630A1	INTERNAL GLASS PUSHING CAP	3.000	PC	VM1631A0	PLUS INNER GLASS PUSHING CAP	2.000	PC	VM2259A1	6 SERIES DOOR LOWER LEFT CAP	1.000	PC	VM2260A1	6 SERIES DOOR UPPER LEFT CAP	1.000	PC	VM2261A1	MM DOOR LOWER RIGHT CAP	1.000	PC	VM2262A1	MM DOOR UPPER RIGHT CAP	1.000	PC
Code	Description	Qty	UOM																																																																										
CE1290A0	EXTRACTABL E FEMALE TERMINAL CPF 5/4	1.000	PC																																																																										
GN1525A0	O-RING INT DIAM 9,5 THK 1 NBR 70	1.000	PC																																																																										
LP1019A0	6 SERIES L200 LED LIGHT BAR - E415	1.000	PC																																																																										
LP1025A0	L=415 LED LIGHT BAR COVER	1.000	PC																																																																										
MG1083A2	MM COMPLETE HANDLE	1.000	PC																																																																										
SL1170A1	S57 BLACK SILICON - 310ml CARTRIDGE	30.000	ML																																																																										
VE1030A1	MAGNET FOR DOOR MICROSWITC H D=22,9mm	1.000	PC																																																																										
VI1034A0	STAINLESS STEEL WASHER 8,4x16x1	1.000	PC																																																																										
VI1147A0	5X25 STAINLESS STEEL SCREW	16.000	PC																																																																										
VI1220A1	4,2x12 TCB SELF-TAPPIN G SCREW	25.000	PC																																																																										
VI1996A0	M5x35 SCREW	13.000	PC																																																																										
VM1630A1	INTERNAL GLASS PUSHING CAP	3.000	PC																																																																										
VM1631A0	PLUS INNER GLASS PUSHING CAP	2.000	PC																																																																										
VM2259A1	6 SERIES DOOR LOWER LEFT CAP	1.000	PC																																																																										
VM2260A1	6 SERIES DOOR UPPER LEFT CAP	1.000	PC																																																																										
VM2261A1	MM DOOR LOWER RIGHT CAP	1.000	PC																																																																										
VM2262A1	MM DOOR UPPER RIGHT CAP	1.000	PC																																																																										



COMPONENT			SPARE PART																																																														
Code	Description	Image	Code	Description	Kit components																																																												
OB1108B	XEVC-0511 DOOR EXTERNAL RIGHT COLUMN		KDR1261A	0511 RIGHT EXTERNAL DOOR	<table border="1"> <thead> <tr> <th>Code</th> <th>Description</th> <th>Qty</th> <th>UOM</th> </tr> </thead> <tbody> <tr> <td>VM2267A0</td> <td>INTERNAL GLASS LOCKING SYSTEM SLIDER</td> <td>2.000</td> <td>PC</td> </tr> <tr> <td>VM2268A0</td> <td>DOOR MAGNET COVER</td> <td>2.000</td> <td>PC</td> </tr> <tr> <td>VM2269A0</td> <td>INTERNAL GLASS LOCKING SYSTEM CAP</td> <td>2.000</td> <td>PC</td> </tr> <tr> <td>VM2274A0</td> <td>GROOVED BUSHING</td> <td>1.000</td> <td>PC</td> </tr> <tr> <td>VM2275A0</td> <td>SMOOTH BUSHING</td> <td>1.000</td> <td>PC</td> </tr> <tr> <td>VM2284A0</td> <td>750 SERIES DRIP PROFILE</td> <td>1.000</td> <td>PC</td> </tr> <tr> <td>VM2305A0</td> <td>MM SERIES DOOR CAP FIXING PAWL</td> <td>14.000</td> <td>PC</td> </tr> <tr> <td>VM2312A0</td> <td>MM DRIP PROFILE DRAIN LEFT PIPE</td> <td>1.000</td> <td>PC</td> </tr> <tr> <td>VM2314A0</td> <td>MM DRIP PROFILE CAP</td> <td>1.000</td> <td>PC</td> </tr> <tr> <td>VM2315A0</td> <td>MIND.Maps INTERNAL GLASS CAP SUPPORT</td> <td>3.000</td> <td>PC</td> </tr> <tr> <td>VM2505A0</td> <td>MM PLUS INTERNAL GLASS SUPPORT</td> <td>2.000</td> <td>PC</td> </tr> <tr> <td>VM2518A0</td> <td>BOARD COOLING FAN SUPPORT</td> <td>1.000</td> <td>PC</td> </tr> <tr> <td>VN1179A1</td> <td>CONTROL BOARD 40x40x20mm 12V COOLING FAN</td> <td>1.000</td> <td>PC</td> </tr> <tr> <td>VT1276A0</td> <td>XEVC-0511-E DOOR EXTERNAL GLASS</td> <td>1.000</td> <td>PC</td> </tr> </tbody> </table>	Code	Description	Qty	UOM	VM2267A0	INTERNAL GLASS LOCKING SYSTEM SLIDER	2.000	PC	VM2268A0	DOOR MAGNET COVER	2.000	PC	VM2269A0	INTERNAL GLASS LOCKING SYSTEM CAP	2.000	PC	VM2274A0	GROOVED BUSHING	1.000	PC	VM2275A0	SMOOTH BUSHING	1.000	PC	VM2284A0	750 SERIES DRIP PROFILE	1.000	PC	VM2305A0	MM SERIES DOOR CAP FIXING PAWL	14.000	PC	VM2312A0	MM DRIP PROFILE DRAIN LEFT PIPE	1.000	PC	VM2314A0	MM DRIP PROFILE CAP	1.000	PC	VM2315A0	MIND.Maps INTERNAL GLASS CAP SUPPORT	3.000	PC	VM2505A0	MM PLUS INTERNAL GLASS SUPPORT	2.000	PC	VM2518A0	BOARD COOLING FAN SUPPORT	1.000	PC	VN1179A1	CONTROL BOARD 40x40x20mm 12V COOLING FAN	1.000	PC	VT1276A0	XEVC-0511-E DOOR EXTERNAL GLASS	1.000	PC
Code	Description	Qty	UOM																																																														
VM2267A0	INTERNAL GLASS LOCKING SYSTEM SLIDER	2.000	PC																																																														
VM2268A0	DOOR MAGNET COVER	2.000	PC																																																														
VM2269A0	INTERNAL GLASS LOCKING SYSTEM CAP	2.000	PC																																																														
VM2274A0	GROOVED BUSHING	1.000	PC																																																														
VM2275A0	SMOOTH BUSHING	1.000	PC																																																														
VM2284A0	750 SERIES DRIP PROFILE	1.000	PC																																																														
VM2305A0	MM SERIES DOOR CAP FIXING PAWL	14.000	PC																																																														
VM2312A0	MM DRIP PROFILE DRAIN LEFT PIPE	1.000	PC																																																														
VM2314A0	MM DRIP PROFILE CAP	1.000	PC																																																														
VM2315A0	MIND.Maps INTERNAL GLASS CAP SUPPORT	3.000	PC																																																														
VM2505A0	MM PLUS INTERNAL GLASS SUPPORT	2.000	PC																																																														
VM2518A0	BOARD COOLING FAN SUPPORT	1.000	PC																																																														
VN1179A1	CONTROL BOARD 40x40x20mm 12V COOLING FAN	1.000	PC																																																														
VT1276A0	XEVC-0511-E DOOR EXTERNAL GLASS	1.000	PC																																																														



COMPONENT			SPARE PART																																																																		
Code	Description	Image	Code	Description	Kit components																																																																
OB1109A	XEVC-0511-E RIGHT INT DOOR COLUMN		KDR1325A	0511 ZERO RIGHT -M EXTERNAL DOOR	<table border="1"> <thead> <tr> <th>Code</th> <th>Description</th> <th>Qty</th> <th>UOM</th> </tr> </thead> <tbody> <tr> <td>OB1106A0</td> <td>XEVC-0511-E DOOR EXTERNAL LEFT COLUMN</td> <td>1.000</td> <td>PC</td> </tr> <tr> <td>OB1107A1</td> <td>XEVC-0511-E LEFT INT DOOR COLUM</td> <td>1.000</td> <td>PC</td> </tr> <tr> <td>OB1108B1</td> <td>XEVC-0511 DOOR EXTERNAL RIGHT COLUM</td> <td>1.000</td> <td>PC</td> </tr> <tr> <td>OB1109A1</td> <td>XEVC-0511-E RIGHT INT DOOR COLUM</td> <td>1.000</td> <td>PC</td> </tr> <tr> <td>OB1122B0</td> <td>MM CT 750mm DOOR LOWER BEAM</td> <td>1.000</td> <td>PC</td> </tr> <tr> <td>OB1166A1</td> <td>XEVC-0511-E EXT GLASS SUPPORT PROFILE</td> <td>2.000</td> <td>PC</td> </tr> <tr> <td>OB1216B0</td> <td>MM DOUBLE GLASS DOOR 750mm UPPER BEAM</td> <td>1.000</td> <td>PC</td> </tr> <tr> <td>OB1217A1</td> <td>MM DOUBLE GLASS DOOR INT UPPER BEAM 750</td> <td>1.000</td> <td>PC</td> </tr> <tr> <td>0H2892A0</td> <td>LED BAR UPPER CAP PLATE</td> <td>1.000</td> <td>PC</td> </tr> <tr> <td>0H2893A0</td> <td>LED BAR LOWER CAP PLATE</td> <td>1.000</td> <td>PC</td> </tr> <tr> <td>CE1096A0</td> <td>4 POLES MICROFIT 3 M BUS CABLE</td> <td>1.000</td> <td>PC</td> </tr> <tr> <td>CE1285A0</td> <td>EMI ROUND FERRITE MOD.26438015 02</td> <td>2.000</td> <td>PC</td> </tr> <tr> <td>CE1851A0</td> <td>MICROFIT CABLE 2P M-F-F AWG22</td> <td>1.000</td> <td>PC</td> </tr> <tr> <td>CE2001A0</td> <td>MICROFIT CABLE 2PM-100-2PM 2AWG22</td> <td>1.000</td> <td>PC</td> </tr> <tr> <td>CE2002A0</td> <td>MICROFIT CABLE 2PM-100-AMP MODU2 2AWG22</td> <td>1.000</td> <td>PC</td> </tr> </tbody> </table>	Code	Description	Qty	UOM	OB1106A0	XEVC-0511-E DOOR EXTERNAL LEFT COLUMN	1.000	PC	OB1107A1	XEVC-0511-E LEFT INT DOOR COLUM	1.000	PC	OB1108B1	XEVC-0511 DOOR EXTERNAL RIGHT COLUM	1.000	PC	OB1109A1	XEVC-0511-E RIGHT INT DOOR COLUM	1.000	PC	OB1122B0	MM CT 750mm DOOR LOWER BEAM	1.000	PC	OB1166A1	XEVC-0511-E EXT GLASS SUPPORT PROFILE	2.000	PC	OB1216B0	MM DOUBLE GLASS DOOR 750mm UPPER BEAM	1.000	PC	OB1217A1	MM DOUBLE GLASS DOOR INT UPPER BEAM 750	1.000	PC	0H2892A0	LED BAR UPPER CAP PLATE	1.000	PC	0H2893A0	LED BAR LOWER CAP PLATE	1.000	PC	CE1096A0	4 POLES MICROFIT 3 M BUS CABLE	1.000	PC	CE1285A0	EMI ROUND FERRITE MOD.26438015 02	2.000	PC	CE1851A0	MICROFIT CABLE 2P M-F-F AWG22	1.000	PC	CE2001A0	MICROFIT CABLE 2PM-100-2PM 2AWG22	1.000	PC	CE2002A0	MICROFIT CABLE 2PM-100-AMP MODU2 2AWG22	1.000	PC
					Code	Description	Qty	UOM																																																													
					OB1106A0	XEVC-0511-E DOOR EXTERNAL LEFT COLUMN	1.000	PC																																																													
					OB1107A1	XEVC-0511-E LEFT INT DOOR COLUM	1.000	PC																																																													
					OB1108B1	XEVC-0511 DOOR EXTERNAL RIGHT COLUM	1.000	PC																																																													
					OB1109A1	XEVC-0511-E RIGHT INT DOOR COLUM	1.000	PC																																																													
					OB1122B0	MM CT 750mm DOOR LOWER BEAM	1.000	PC																																																													
					OB1166A1	XEVC-0511-E EXT GLASS SUPPORT PROFILE	2.000	PC																																																													
					OB1216B0	MM DOUBLE GLASS DOOR 750mm UPPER BEAM	1.000	PC																																																													
					OB1217A1	MM DOUBLE GLASS DOOR INT UPPER BEAM 750	1.000	PC																																																													
					0H2892A0	LED BAR UPPER CAP PLATE	1.000	PC																																																													
					0H2893A0	LED BAR LOWER CAP PLATE	1.000	PC																																																													
					CE1096A0	4 POLES MICROFIT 3 M BUS CABLE	1.000	PC																																																													
					CE1285A0	EMI ROUND FERRITE MOD.26438015 02	2.000	PC																																																													
					CE1851A0	MICROFIT CABLE 2P M-F-F AWG22	1.000	PC																																																													
CE2001A0	MICROFIT CABLE 2PM-100-2PM 2AWG22	1.000	PC																																																																		
CE2002A0	MICROFIT CABLE 2PM-100-AMP MODU2 2AWG22	1.000	PC																																																																		



COMPONENT			SPARE PART																																																																						
Code	Description	Image	Code	Description	Kit components																																																																				
OB1109A	XEVC-0511-E RIGHT INT DOOR COLUMN		KDR1325A	0511 ZERO RIGHT -M EXTERNAL DOOR	<table border="1"> <thead> <tr> <th>Code</th> <th>Description</th> <th>Qty</th> <th>UOM</th> </tr> </thead> <tbody> <tr> <td>GN1525A0</td> <td>O-RING INT DIAM 9,5 THK 1 NBR 70</td> <td>1.000</td> <td>PC</td> </tr> <tr> <td>LP1019A0</td> <td>6 SERIES L200 LED LIGHT BAR - E415</td> <td>1.000</td> <td>PC</td> </tr> <tr> <td>MG1099A1</td> <td>MM COMPLETE HANDLE</td> <td>1.000</td> <td>PC</td> </tr> <tr> <td>RC1200A0</td> <td>ED=4 WIRE D=0.5 H24 COMPRESSIO N SPRING</td> <td>4.000</td> <td>PC</td> </tr> <tr> <td>SL1170A1</td> <td>S57 BLACK SILICON - 310ml CARTRIDGE</td> <td>30.000</td> <td>ML</td> </tr> <tr> <td>SL1221A0</td> <td>GN1/1 EXTERNAL GLASS UPPER SILICONE</td> <td>1.000</td> <td>PC</td> </tr> <tr> <td>SL1222A0</td> <td>0511 EXTERNAL GLASS LATERAL SILICONE</td> <td>4.000</td> <td>PC</td> </tr> <tr> <td>VE1030A1</td> <td>MAGNET FOR DOOR MICROSWITC H D=22,9mm</td> <td>1.000</td> <td>PC</td> </tr> <tr> <td>VI0239A1</td> <td>SELF-TAPPIN G SCREW 4.2X25 TCB+ INOX</td> <td>4.000</td> <td>PC</td> </tr> <tr> <td>VI1034A0</td> <td>STAINLESS STEEL WASHER 8.4x16x1</td> <td>1.000</td> <td>PC</td> </tr> <tr> <td>VI1074A0</td> <td>4X16 SCREW FOR PLASTIC</td> <td>2.000</td> <td>PC</td> </tr> <tr> <td>VI1103A0</td> <td>40X12 TBSP SCREW FOR PLASTIC</td> <td>2.000</td> <td>PC</td> </tr> <tr> <td>VI1220A1</td> <td>4,2x12 TCB SELF-TAPPIN G SCREW</td> <td>26.000</td> <td>PC</td> </tr> <tr> <td>VI1930A1</td> <td>5x20 ST. STEEL CHIP SCREW</td> <td>16.000</td> <td>PC</td> </tr> <tr> <td>VI1996A0</td> <td>M5x35 SCREW</td> <td>13.000</td> <td>PC</td> </tr> <tr> <td>VI2070A0</td> <td>SHEETTRACS TCB+ 40x8 SELF-THREAD SCREW</td> <td>6.000</td> <td>PC</td> </tr> </tbody> </table>	Code	Description	Qty	UOM	GN1525A0	O-RING INT DIAM 9,5 THK 1 NBR 70	1.000	PC	LP1019A0	6 SERIES L200 LED LIGHT BAR - E415	1.000	PC	MG1099A1	MM COMPLETE HANDLE	1.000	PC	RC1200A0	ED=4 WIRE D=0.5 H24 COMPRESSIO N SPRING	4.000	PC	SL1170A1	S57 BLACK SILICON - 310ml CARTRIDGE	30.000	ML	SL1221A0	GN1/1 EXTERNAL GLASS UPPER SILICONE	1.000	PC	SL1222A0	0511 EXTERNAL GLASS LATERAL SILICONE	4.000	PC	VE1030A1	MAGNET FOR DOOR MICROSWITC H D=22,9mm	1.000	PC	VI0239A1	SELF-TAPPIN G SCREW 4.2X25 TCB+ INOX	4.000	PC	VI1034A0	STAINLESS STEEL WASHER 8.4x16x1	1.000	PC	VI1074A0	4X16 SCREW FOR PLASTIC	2.000	PC	VI1103A0	40X12 TBSP SCREW FOR PLASTIC	2.000	PC	VI1220A1	4,2x12 TCB SELF-TAPPIN G SCREW	26.000	PC	VI1930A1	5x20 ST. STEEL CHIP SCREW	16.000	PC	VI1996A0	M5x35 SCREW	13.000	PC	VI2070A0	SHEETTRACS TCB+ 40x8 SELF-THREAD SCREW	6.000	PC
					Code	Description	Qty	UOM																																																																	
					GN1525A0	O-RING INT DIAM 9,5 THK 1 NBR 70	1.000	PC																																																																	
					LP1019A0	6 SERIES L200 LED LIGHT BAR - E415	1.000	PC																																																																	
					MG1099A1	MM COMPLETE HANDLE	1.000	PC																																																																	
					RC1200A0	ED=4 WIRE D=0.5 H24 COMPRESSIO N SPRING	4.000	PC																																																																	
					SL1170A1	S57 BLACK SILICON - 310ml CARTRIDGE	30.000	ML																																																																	
					SL1221A0	GN1/1 EXTERNAL GLASS UPPER SILICONE	1.000	PC																																																																	
					SL1222A0	0511 EXTERNAL GLASS LATERAL SILICONE	4.000	PC																																																																	
					VE1030A1	MAGNET FOR DOOR MICROSWITC H D=22,9mm	1.000	PC																																																																	
					VI0239A1	SELF-TAPPIN G SCREW 4.2X25 TCB+ INOX	4.000	PC																																																																	
					VI1034A0	STAINLESS STEEL WASHER 8.4x16x1	1.000	PC																																																																	
					VI1074A0	4X16 SCREW FOR PLASTIC	2.000	PC																																																																	
					VI1103A0	40X12 TBSP SCREW FOR PLASTIC	2.000	PC																																																																	
					VI1220A1	4,2x12 TCB SELF-TAPPIN G SCREW	26.000	PC																																																																	
VI1930A1	5x20 ST. STEEL CHIP SCREW	16.000	PC																																																																						
VI1996A0	M5x35 SCREW	13.000	PC																																																																						
VI2070A0	SHEETTRACS TCB+ 40x8 SELF-THREAD SCREW	6.000	PC																																																																						



COMPONENT			SPARE PART																																																																														
Code	Description	Image	Code	Description	Kit components																																																																												
OB1109A	XEVC-0511-E RIGHT INT DOOR COLUMN		KDR1325A	0511 ZERO RIGHT -M EXTERNAL DOOR	<table border="1"> <thead> <tr> <th>Code</th> <th>Description</th> <th>Qty</th> <th>UOM</th> </tr> </thead> <tbody> <tr> <td>VM1490A0</td> <td>CHEFTOP/BAK ERTOP HANDLE SCREWS COVER</td> <td>2.000</td> <td>PC</td> </tr> <tr> <td>VM1630A1</td> <td>INTERNAL GLASS PUSHING CAP</td> <td>3.000</td> <td>PC</td> </tr> <tr> <td>VM1631A0</td> <td>PLUS INNER GLASS PUSHING CAP</td> <td>3.000</td> <td>PC</td> </tr> <tr> <td>VM2259B0</td> <td>VM2259B0</td> <td>1.000</td> <td>PC</td> </tr> <tr> <td>VM2260B0</td> <td>S6 LEFT UPPER CAP</td> <td>1.000</td> <td>PC</td> </tr> <tr> <td>VM2261B0</td> <td>MM -M DOOR RIGHT LOWER CAP</td> <td>1.000</td> <td>PC</td> </tr> <tr> <td>VM2262B0</td> <td>MM -M DOOR RIGHT UPPER CAP</td> <td>1.000</td> <td>PC</td> </tr> <tr> <td>VM2267A0</td> <td>INTERNAL GLASS LOCKING SYSTEM SLIDER</td> <td>2.000</td> <td>PC</td> </tr> <tr> <td>VM2268A0</td> <td>DOOR MAGNET COVER</td> <td>2.000</td> <td>PC</td> </tr> <tr> <td>VM2269B0</td> <td>INNER GLASS FIXING CAP</td> <td>2.000</td> <td>PC</td> </tr> <tr> <td>VM2274A0</td> <td>GROOVED BUSHING</td> <td>1.000</td> <td>PC</td> </tr> <tr> <td>VM2275A0</td> <td>SMOOTH BUSHING</td> <td>1.000</td> <td>PC</td> </tr> <tr> <td>VM2284B0</td> <td>750 SERIES DRIP PROFILE KIT</td> <td>1.000</td> <td>PC</td> </tr> <tr> <td>VM2305A0</td> <td>MM SERIES DOOR CAP FIXING PAWL</td> <td>14.000</td> <td>PC</td> </tr> <tr> <td>VM2312A0</td> <td>MM DRIP PROFILE DRAIN LEFT PIPE</td> <td>1.000</td> <td>PC</td> </tr> <tr> <td>VM2314A0</td> <td>MM DRIP PROFILE CAP</td> <td>1.000</td> <td>PC</td> </tr> <tr> <td>VM2315B0</td> <td>S6 INTERNAL GLASS SUPPORT</td> <td>3.000</td> <td>PC</td> </tr> <tr> <td>VM2505B1</td> <td>MM PLUS INTERNAL GLASS SUPPORT</td> <td>3.000</td> <td>PC</td> </tr> </tbody> </table>	Code	Description	Qty	UOM	VM1490A0	CHEFTOP/BAK ERTOP HANDLE SCREWS COVER	2.000	PC	VM1630A1	INTERNAL GLASS PUSHING CAP	3.000	PC	VM1631A0	PLUS INNER GLASS PUSHING CAP	3.000	PC	VM2259B0	VM2259B0	1.000	PC	VM2260B0	S6 LEFT UPPER CAP	1.000	PC	VM2261B0	MM -M DOOR RIGHT LOWER CAP	1.000	PC	VM2262B0	MM -M DOOR RIGHT UPPER CAP	1.000	PC	VM2267A0	INTERNAL GLASS LOCKING SYSTEM SLIDER	2.000	PC	VM2268A0	DOOR MAGNET COVER	2.000	PC	VM2269B0	INNER GLASS FIXING CAP	2.000	PC	VM2274A0	GROOVED BUSHING	1.000	PC	VM2275A0	SMOOTH BUSHING	1.000	PC	VM2284B0	750 SERIES DRIP PROFILE KIT	1.000	PC	VM2305A0	MM SERIES DOOR CAP FIXING PAWL	14.000	PC	VM2312A0	MM DRIP PROFILE DRAIN LEFT PIPE	1.000	PC	VM2314A0	MM DRIP PROFILE CAP	1.000	PC	VM2315B0	S6 INTERNAL GLASS SUPPORT	3.000	PC	VM2505B1	MM PLUS INTERNAL GLASS SUPPORT	3.000	PC
Code	Description	Qty	UOM																																																																														
VM1490A0	CHEFTOP/BAK ERTOP HANDLE SCREWS COVER	2.000	PC																																																																														
VM1630A1	INTERNAL GLASS PUSHING CAP	3.000	PC																																																																														
VM1631A0	PLUS INNER GLASS PUSHING CAP	3.000	PC																																																																														
VM2259B0	VM2259B0	1.000	PC																																																																														
VM2260B0	S6 LEFT UPPER CAP	1.000	PC																																																																														
VM2261B0	MM -M DOOR RIGHT LOWER CAP	1.000	PC																																																																														
VM2262B0	MM -M DOOR RIGHT UPPER CAP	1.000	PC																																																																														
VM2267A0	INTERNAL GLASS LOCKING SYSTEM SLIDER	2.000	PC																																																																														
VM2268A0	DOOR MAGNET COVER	2.000	PC																																																																														
VM2269B0	INNER GLASS FIXING CAP	2.000	PC																																																																														
VM2274A0	GROOVED BUSHING	1.000	PC																																																																														
VM2275A0	SMOOTH BUSHING	1.000	PC																																																																														
VM2284B0	750 SERIES DRIP PROFILE KIT	1.000	PC																																																																														
VM2305A0	MM SERIES DOOR CAP FIXING PAWL	14.000	PC																																																																														
VM2312A0	MM DRIP PROFILE DRAIN LEFT PIPE	1.000	PC																																																																														
VM2314A0	MM DRIP PROFILE CAP	1.000	PC																																																																														
VM2315B0	S6 INTERNAL GLASS SUPPORT	3.000	PC																																																																														
VM2505B1	MM PLUS INTERNAL GLASS SUPPORT	3.000	PC																																																																														



COMPONENT			SPARE PART																																															
Code	Description	Image	Code	Description	Kit components																																													
OB1109A	XEVC-0511-E RIGHT INT DOOR COLUMN		KDR1325A	0511 ZERO RIGHT -M EXTERNAL DOOR	<table border="1"> <thead> <tr> <th>Code</th> <th>Description</th> <th>Qty</th> <th>UOM</th> </tr> </thead> <tbody> <tr> <td>VP1080A0</td> <td>UPPER HINGE CAP FOR LOWER INNER GLASS</td> <td>1.000</td> <td>PC</td> </tr> <tr> <td>VP1081A0</td> <td>UPPER HINGE CAP FOR UPPER INNER GLASS</td> <td>1.000</td> <td>PC</td> </tr> <tr> <td>VT1276A0</td> <td>XEVC-0511-E DOOR EXTERNAL GLASS</td> <td>1.000</td> <td>PC</td> </tr> </tbody> </table>	Code	Description	Qty	UOM	VP1080A0	UPPER HINGE CAP FOR LOWER INNER GLASS	1.000	PC	VP1081A0	UPPER HINGE CAP FOR UPPER INNER GLASS	1.000	PC	VT1276A0	XEVC-0511-E DOOR EXTERNAL GLASS	1.000	PC																													
			Code	Description	Qty	UOM																																												
VP1080A0	UPPER HINGE CAP FOR LOWER INNER GLASS	1.000	PC																																															
VP1081A0	UPPER HINGE CAP FOR UPPER INNER GLASS	1.000	PC																																															
VT1276A0	XEVC-0511-E DOOR EXTERNAL GLASS	1.000	PC																																															
KDR1269B	BT-04 -M EXTERNAL RIGHT DOOR	<table border="1"> <thead> <tr> <th>Code</th> <th>Description</th> <th>Qty</th> <th>UOM</th> </tr> </thead> <tbody> <tr> <td>OB1107A1</td> <td>XEVC-0511-E LEFT INT DOOR COLUM</td> <td>1.000</td> <td>PC</td> </tr> <tr> <td>OB1108B1</td> <td>XEVC-0511 DOOR EXTERNAL RIGHT COLUM</td> <td>1.000</td> <td>PC</td> </tr> <tr> <td>OB1109A1</td> <td>XEVC-0511-E RIGHT INT DOOR COLUM</td> <td>1.000</td> <td>PC</td> </tr> <tr> <td>OB1126B0</td> <td>860mm DOOR LOWER BEAM</td> <td>1.000</td> <td>PC</td> </tr> <tr> <td>OB1166A1</td> <td>XEVC-0511-E EXT GLASS SUPPORT PROFILE</td> <td>2.000</td> <td>PC</td> </tr> <tr> <td>OB1174A0</td> <td>XEBC-04EU-E LEFT EXT DOOR COLUM</td> <td>1.000</td> <td>PC</td> </tr> <tr> <td>OB1218B0</td> <td>860MM DOUBLE GLASS DOOR UPPER BEAM</td> <td>1.000</td> <td>PC</td> </tr> <tr> <td>OB1219A1</td> <td>MM DOUBLE GLASS DOOR INT UPPER BEAM 860</td> <td>1.000</td> <td>PC</td> </tr> <tr> <td>CE1052A1</td> <td>MM USB-CONTRO L PANEL CONNECTING CABLE</td> <td>1.000</td> <td>PC</td> </tr> <tr> <td>CE1053B0</td> <td>MM MICROFIT LED BAR POWER SUPPLY CABL</td> <td>1.000</td> <td>PC</td> </tr> <tr> <td>CE1097A0</td> <td>4M SIHF 4 POLES MICROFIT CANBUS</td> <td>1.000</td> <td>PC</td> </tr> </tbody> </table>	Code	Description	Qty	UOM	OB1107A1	XEVC-0511-E LEFT INT DOOR COLUM	1.000	PC	OB1108B1	XEVC-0511 DOOR EXTERNAL RIGHT COLUM	1.000	PC	OB1109A1	XEVC-0511-E RIGHT INT DOOR COLUM	1.000	PC	OB1126B0	860mm DOOR LOWER BEAM	1.000	PC	OB1166A1	XEVC-0511-E EXT GLASS SUPPORT PROFILE	2.000	PC	OB1174A0	XEBC-04EU-E LEFT EXT DOOR COLUM	1.000	PC	OB1218B0	860MM DOUBLE GLASS DOOR UPPER BEAM	1.000	PC	OB1219A1	MM DOUBLE GLASS DOOR INT UPPER BEAM 860	1.000	PC	CE1052A1	MM USB-CONTRO L PANEL CONNECTING CABLE	1.000	PC	CE1053B0	MM MICROFIT LED BAR POWER SUPPLY CABL	1.000	PC	CE1097A0	4M SIHF 4 POLES MICROFIT CANBUS	1.000	PC
Code	Description	Qty	UOM																																															
OB1107A1	XEVC-0511-E LEFT INT DOOR COLUM	1.000	PC																																															
OB1108B1	XEVC-0511 DOOR EXTERNAL RIGHT COLUM	1.000	PC																																															
OB1109A1	XEVC-0511-E RIGHT INT DOOR COLUM	1.000	PC																																															
OB1126B0	860mm DOOR LOWER BEAM	1.000	PC																																															
OB1166A1	XEVC-0511-E EXT GLASS SUPPORT PROFILE	2.000	PC																																															
OB1174A0	XEBC-04EU-E LEFT EXT DOOR COLUM	1.000	PC																																															
OB1218B0	860MM DOUBLE GLASS DOOR UPPER BEAM	1.000	PC																																															
OB1219A1	MM DOUBLE GLASS DOOR INT UPPER BEAM 860	1.000	PC																																															
CE1052A1	MM USB-CONTRO L PANEL CONNECTING CABLE	1.000	PC																																															
CE1053B0	MM MICROFIT LED BAR POWER SUPPLY CABL	1.000	PC																																															
CE1097A0	4M SIHF 4 POLES MICROFIT CANBUS	1.000	PC																																															



COMPONENT			SPARE PART																																																																						
Code	Description	Image	Code	Description	Kit components																																																																				
OB1109A	XEVC-0511-E RIGHT INT DOOR COLUMN		KDR1269B	BT-04 -M EXTERNAL RIGHT DOOR	<table border="1"> <thead> <tr> <th>Code</th> <th>Description</th> <th>Qty</th> <th>UOM</th> </tr> </thead> <tbody> <tr> <td>CE1285A0</td> <td>EMI ROUND FERRITE MOD.26438015 02</td> <td>2.000</td> <td>PC</td> </tr> <tr> <td>LP1019A0</td> <td>6 SERIES L200 LED LIGHT BAR - E415</td> <td>1.000</td> <td>PC</td> </tr> <tr> <td>LP1025A0</td> <td>L=415 LED LIGHT BAR COVER</td> <td>1.000</td> <td>PC</td> </tr> <tr> <td>MG1099A1</td> <td>MM COMPLETE HANDLE</td> <td>1.000</td> <td>PC</td> </tr> <tr> <td>RC1200A0</td> <td>ED=4 WIRE D=0.5 H24 COMPRESSIO N SPRING</td> <td>4.000</td> <td>PC</td> </tr> <tr> <td>SL1170A1</td> <td>S57 BLACK SILICON - 310ml CARTRIDGE</td> <td>35.000</td> <td>ML</td> </tr> <tr> <td>SL1222A0</td> <td>0511 EXTERNAL GLASS LATERAL SILICONE</td> <td>4.000</td> <td>PC</td> </tr> <tr> <td>SL1229A0</td> <td>BAKER EXTERNAL GLASS UPPER SILICONE</td> <td>1.000</td> <td>PC</td> </tr> <tr> <td>VE1030A1</td> <td>MAGNET FOR DOOR MICROSWITC H D=22,9mm</td> <td>1.000</td> <td>PC</td> </tr> <tr> <td>VI0239A1</td> <td>SELF-TAPPIN G SCREW 4.2X25 TCB+ INOX</td> <td>4.000</td> <td>PC</td> </tr> <tr> <td>VI1074A0</td> <td>4X16 SCREW FOR PLASTIC</td> <td>2.000</td> <td>PC</td> </tr> <tr> <td>VI1103A0</td> <td>40X12 TBSP SCREW FOR PLASTIC</td> <td>4.000</td> <td>PC</td> </tr> <tr> <td>VI1220A1</td> <td>4,2x12 TCB SELF-TAPPIN G SCREW</td> <td>28.000</td> <td>PC</td> </tr> <tr> <td>VI1930A1</td> <td>5x20 ST. STEEL CHIP SCREW</td> <td>16.000</td> <td>PC</td> </tr> <tr> <td>VI1996A0</td> <td>M5x35 SCREW</td> <td>13.000</td> <td>PC</td> </tr> <tr> <td>VI2070A0</td> <td>SHEETTRACS TCB+ 40x8 SELF-THREAD SCREW</td> <td>6.000</td> <td>PC</td> </tr> </tbody> </table>	Code	Description	Qty	UOM	CE1285A0	EMI ROUND FERRITE MOD.26438015 02	2.000	PC	LP1019A0	6 SERIES L200 LED LIGHT BAR - E415	1.000	PC	LP1025A0	L=415 LED LIGHT BAR COVER	1.000	PC	MG1099A1	MM COMPLETE HANDLE	1.000	PC	RC1200A0	ED=4 WIRE D=0.5 H24 COMPRESSIO N SPRING	4.000	PC	SL1170A1	S57 BLACK SILICON - 310ml CARTRIDGE	35.000	ML	SL1222A0	0511 EXTERNAL GLASS LATERAL SILICONE	4.000	PC	SL1229A0	BAKER EXTERNAL GLASS UPPER SILICONE	1.000	PC	VE1030A1	MAGNET FOR DOOR MICROSWITC H D=22,9mm	1.000	PC	VI0239A1	SELF-TAPPIN G SCREW 4.2X25 TCB+ INOX	4.000	PC	VI1074A0	4X16 SCREW FOR PLASTIC	2.000	PC	VI1103A0	40X12 TBSP SCREW FOR PLASTIC	4.000	PC	VI1220A1	4,2x12 TCB SELF-TAPPIN G SCREW	28.000	PC	VI1930A1	5x20 ST. STEEL CHIP SCREW	16.000	PC	VI1996A0	M5x35 SCREW	13.000	PC	VI2070A0	SHEETTRACS TCB+ 40x8 SELF-THREAD SCREW	6.000	PC
					Code	Description	Qty	UOM																																																																	
					CE1285A0	EMI ROUND FERRITE MOD.26438015 02	2.000	PC																																																																	
					LP1019A0	6 SERIES L200 LED LIGHT BAR - E415	1.000	PC																																																																	
					LP1025A0	L=415 LED LIGHT BAR COVER	1.000	PC																																																																	
					MG1099A1	MM COMPLETE HANDLE	1.000	PC																																																																	
					RC1200A0	ED=4 WIRE D=0.5 H24 COMPRESSIO N SPRING	4.000	PC																																																																	
					SL1170A1	S57 BLACK SILICON - 310ml CARTRIDGE	35.000	ML																																																																	
					SL1222A0	0511 EXTERNAL GLASS LATERAL SILICONE	4.000	PC																																																																	
					SL1229A0	BAKER EXTERNAL GLASS UPPER SILICONE	1.000	PC																																																																	
					VE1030A1	MAGNET FOR DOOR MICROSWITC H D=22,9mm	1.000	PC																																																																	
					VI0239A1	SELF-TAPPIN G SCREW 4.2X25 TCB+ INOX	4.000	PC																																																																	
					VI1074A0	4X16 SCREW FOR PLASTIC	2.000	PC																																																																	
					VI1103A0	40X12 TBSP SCREW FOR PLASTIC	4.000	PC																																																																	
					VI1220A1	4,2x12 TCB SELF-TAPPIN G SCREW	28.000	PC																																																																	
VI1930A1	5x20 ST. STEEL CHIP SCREW	16.000	PC																																																																						
VI1996A0	M5x35 SCREW	13.000	PC																																																																						
VI2070A0	SHEETTRACS TCB+ 40x8 SELF-THREAD SCREW	6.000	PC																																																																						



COMPONENT			SPARE PART																																																																														
Code	Description	Image	Code	Description	Kit components																																																																												
OB1109A	XEVC-0511-E RIGHT INT DOOR COLUMN		KDR1269B	BT-04 -M EXTERNAL RIGHT DOOR	<table border="1"> <thead> <tr> <th>Code</th> <th>Description</th> <th>Qty</th> <th>UOM</th> </tr> </thead> <tbody> <tr> <td>VM1490A0</td> <td>CHEFTOP/BAK ERTOP HANDLE SCREWS COVER</td> <td>2.000</td> <td>PC</td> </tr> <tr> <td>VM1630A1</td> <td>INTERNAL GLASS PUSHING CAP</td> <td>3.000</td> <td>PC</td> </tr> <tr> <td>VM1631A0</td> <td>PLUS INNER GLASS PUSHING CAP</td> <td>3.000</td> <td>PC</td> </tr> <tr> <td>VM2259B0</td> <td>VM2259B0</td> <td>1.000</td> <td>PC</td> </tr> <tr> <td>VM2260B0</td> <td>S6 LEFT UPPER CAP</td> <td>1.000</td> <td>PC</td> </tr> <tr> <td>VM2261B0</td> <td>MM -M DOOR RIGHT LOWER CAP</td> <td>1.000</td> <td>PC</td> </tr> <tr> <td>VM2262B0</td> <td>MM -M DOOR RIGHT UPPER CAP</td> <td>1.000</td> <td>PC</td> </tr> <tr> <td>VM2267A0</td> <td>INTERNAL GLASS LOCKING SYSTEM SLIDER</td> <td>2.000</td> <td>PC</td> </tr> <tr> <td>VM2268A0</td> <td>DOOR MAGNET COVER</td> <td>2.000</td> <td>PC</td> </tr> <tr> <td>VM2269B0</td> <td>INNER GLASS FIXING CAP</td> <td>2.000</td> <td>PC</td> </tr> <tr> <td>VM2274A0</td> <td>GROOVED BUSHING</td> <td>1.000</td> <td>PC</td> </tr> <tr> <td>VM2275A0</td> <td>SMOOTH BUSHING</td> <td>1.000</td> <td>PC</td> </tr> <tr> <td>VM2285B0</td> <td>860 SERIES DRIP PROFILE KIT</td> <td>1.000</td> <td>PC</td> </tr> <tr> <td>VM2305A0</td> <td>MM SERIES DOOR CAP FIXING PAWL</td> <td>14.000</td> <td>PC</td> </tr> <tr> <td>VM2312A0</td> <td>MM DRIP PROFILE DRAIN LEFT PIPE</td> <td>1.000</td> <td>PC</td> </tr> <tr> <td>VM2314A0</td> <td>MM DRIP PROFILE CAP</td> <td>1.000</td> <td>PC</td> </tr> <tr> <td>VM2315B0</td> <td>S6 INTERNAL GLASS SUPPORT</td> <td>3.000</td> <td>PC</td> </tr> <tr> <td>VM2505B1</td> <td>MM PLUS INTERNAL GLASS SUPPORT</td> <td>3.000</td> <td>PC</td> </tr> </tbody> </table>	Code	Description	Qty	UOM	VM1490A0	CHEFTOP/BAK ERTOP HANDLE SCREWS COVER	2.000	PC	VM1630A1	INTERNAL GLASS PUSHING CAP	3.000	PC	VM1631A0	PLUS INNER GLASS PUSHING CAP	3.000	PC	VM2259B0	VM2259B0	1.000	PC	VM2260B0	S6 LEFT UPPER CAP	1.000	PC	VM2261B0	MM -M DOOR RIGHT LOWER CAP	1.000	PC	VM2262B0	MM -M DOOR RIGHT UPPER CAP	1.000	PC	VM2267A0	INTERNAL GLASS LOCKING SYSTEM SLIDER	2.000	PC	VM2268A0	DOOR MAGNET COVER	2.000	PC	VM2269B0	INNER GLASS FIXING CAP	2.000	PC	VM2274A0	GROOVED BUSHING	1.000	PC	VM2275A0	SMOOTH BUSHING	1.000	PC	VM2285B0	860 SERIES DRIP PROFILE KIT	1.000	PC	VM2305A0	MM SERIES DOOR CAP FIXING PAWL	14.000	PC	VM2312A0	MM DRIP PROFILE DRAIN LEFT PIPE	1.000	PC	VM2314A0	MM DRIP PROFILE CAP	1.000	PC	VM2315B0	S6 INTERNAL GLASS SUPPORT	3.000	PC	VM2505B1	MM PLUS INTERNAL GLASS SUPPORT	3.000	PC
Code	Description	Qty	UOM																																																																														
VM1490A0	CHEFTOP/BAK ERTOP HANDLE SCREWS COVER	2.000	PC																																																																														
VM1630A1	INTERNAL GLASS PUSHING CAP	3.000	PC																																																																														
VM1631A0	PLUS INNER GLASS PUSHING CAP	3.000	PC																																																																														
VM2259B0	VM2259B0	1.000	PC																																																																														
VM2260B0	S6 LEFT UPPER CAP	1.000	PC																																																																														
VM2261B0	MM -M DOOR RIGHT LOWER CAP	1.000	PC																																																																														
VM2262B0	MM -M DOOR RIGHT UPPER CAP	1.000	PC																																																																														
VM2267A0	INTERNAL GLASS LOCKING SYSTEM SLIDER	2.000	PC																																																																														
VM2268A0	DOOR MAGNET COVER	2.000	PC																																																																														
VM2269B0	INNER GLASS FIXING CAP	2.000	PC																																																																														
VM2274A0	GROOVED BUSHING	1.000	PC																																																																														
VM2275A0	SMOOTH BUSHING	1.000	PC																																																																														
VM2285B0	860 SERIES DRIP PROFILE KIT	1.000	PC																																																																														
VM2305A0	MM SERIES DOOR CAP FIXING PAWL	14.000	PC																																																																														
VM2312A0	MM DRIP PROFILE DRAIN LEFT PIPE	1.000	PC																																																																														
VM2314A0	MM DRIP PROFILE CAP	1.000	PC																																																																														
VM2315B0	S6 INTERNAL GLASS SUPPORT	3.000	PC																																																																														
VM2505B1	MM PLUS INTERNAL GLASS SUPPORT	3.000	PC																																																																														



COMPONENT			SPARE PART																																							
Code	Description	Image	Code	Description	Kit components																																					
0B1109A	XEVC-0511-E RIGHT INT DOOR COLUMN		KDR1269B	BT-04 -M EXTERNAL RIGHT DOOR	<table border="1"> <thead> <tr> <th>Code</th> <th>Description</th> <th>Qty</th> <th>UOM</th> </tr> </thead> <tbody> <tr> <td>VM2518A0</td> <td>BOARD COOLING FAN SUPPORT</td> <td>1.000</td> <td>PC</td> </tr> <tr> <td>VN1179A1</td> <td>CONTROL BOARD 40x40x20mm 12V COOLING FAN</td> <td>1.000</td> <td>PC</td> </tr> <tr> <td>VP1080A0</td> <td>UPPER HINGE CAP FOR LOWER INNER GLASS</td> <td>1.000</td> <td>PC</td> </tr> <tr> <td>VP1081A0</td> <td>UPPER HINGE CAP FOR UPPER INNER GLASS</td> <td>1.000</td> <td>PC</td> </tr> <tr> <td>VT1290A0</td> <td>EXTERNAL GLASS XEBC-04EU-E</td> <td>1.000</td> <td>PC</td> </tr> </tbody> </table>	Code	Description	Qty	UOM	VM2518A0	BOARD COOLING FAN SUPPORT	1.000	PC	VN1179A1	CONTROL BOARD 40x40x20mm 12V COOLING FAN	1.000	PC	VP1080A0	UPPER HINGE CAP FOR LOWER INNER GLASS	1.000	PC	VP1081A0	UPPER HINGE CAP FOR UPPER INNER GLASS	1.000	PC	VT1290A0	EXTERNAL GLASS XEBC-04EU-E	1.000	PC													
			Code	Description	Qty	UOM																																				
VM2518A0	BOARD COOLING FAN SUPPORT	1.000	PC																																							
VN1179A1	CONTROL BOARD 40x40x20mm 12V COOLING FAN	1.000	PC																																							
VP1080A0	UPPER HINGE CAP FOR LOWER INNER GLASS	1.000	PC																																							
VP1081A0	UPPER HINGE CAP FOR UPPER INNER GLASS	1.000	PC																																							
VT1290A0	EXTERNAL GLASS XEBC-04EU-E	1.000	PC																																							
KDR1269A	BT-04 EXTERNAL RIGHT DOOR	<table border="1"> <thead> <tr> <th>Code</th> <th>Description</th> <th>Qty</th> <th>UOM</th> </tr> </thead> <tbody> <tr> <td>0B1107A1</td> <td>XEVC-0511-E LEFT INT DOOR COLUM</td> <td>1.000</td> <td>PC</td> </tr> <tr> <td>0B1108B1</td> <td>XEVC-0511 DOOR EXTERNAL RIGHT COLUM</td> <td>1.000</td> <td>PC</td> </tr> <tr> <td>0B1109A1</td> <td>XEVC-0511-E RIGHT INT DOOR COLUM</td> <td>1.000</td> <td>PC</td> </tr> <tr> <td>0B1126A1</td> <td>860mm DOOR LOWER FRAME SHAPE</td> <td>1.000</td> <td>PC</td> </tr> <tr> <td>0B1166A1</td> <td>XEVC-0511-E EXT GLASS SUPPORT PROFILE</td> <td>2.000</td> <td>PC</td> </tr> <tr> <td>0B1174A0</td> <td>XEBC-04EU-E LEFT EXT DOOR COLUM</td> <td>1.000</td> <td>PC</td> </tr> <tr> <td>0B1218A1</td> <td>860MM DOUBLE GLASS DOOR UPPER BEAM</td> <td>1.000</td> <td>PC</td> </tr> <tr> <td>0B1219A1</td> <td>MM DOUBLE GLASS DOOR INT UPPER BEAM 860</td> <td>1.000</td> <td>PC</td> </tr> <tr> <td>CE1052A1</td> <td>MM USB-CONTRO L PANEL CONNECTING CABLE</td> <td>1.000</td> <td>PC</td> </tr> </tbody> </table>	Code	Description	Qty	UOM	0B1107A1	XEVC-0511-E LEFT INT DOOR COLUM	1.000	PC	0B1108B1	XEVC-0511 DOOR EXTERNAL RIGHT COLUM	1.000	PC	0B1109A1	XEVC-0511-E RIGHT INT DOOR COLUM	1.000	PC	0B1126A1	860mm DOOR LOWER FRAME SHAPE	1.000	PC	0B1166A1	XEVC-0511-E EXT GLASS SUPPORT PROFILE	2.000	PC	0B1174A0	XEBC-04EU-E LEFT EXT DOOR COLUM	1.000	PC	0B1218A1	860MM DOUBLE GLASS DOOR UPPER BEAM	1.000	PC	0B1219A1	MM DOUBLE GLASS DOOR INT UPPER BEAM 860	1.000	PC	CE1052A1	MM USB-CONTRO L PANEL CONNECTING CABLE	1.000	PC
Code	Description	Qty	UOM																																							
0B1107A1	XEVC-0511-E LEFT INT DOOR COLUM	1.000	PC																																							
0B1108B1	XEVC-0511 DOOR EXTERNAL RIGHT COLUM	1.000	PC																																							
0B1109A1	XEVC-0511-E RIGHT INT DOOR COLUM	1.000	PC																																							
0B1126A1	860mm DOOR LOWER FRAME SHAPE	1.000	PC																																							
0B1166A1	XEVC-0511-E EXT GLASS SUPPORT PROFILE	2.000	PC																																							
0B1174A0	XEBC-04EU-E LEFT EXT DOOR COLUM	1.000	PC																																							
0B1218A1	860MM DOUBLE GLASS DOOR UPPER BEAM	1.000	PC																																							
0B1219A1	MM DOUBLE GLASS DOOR INT UPPER BEAM 860	1.000	PC																																							
CE1052A1	MM USB-CONTRO L PANEL CONNECTING CABLE	1.000	PC																																							



COMPONENT			SPARE PART																																																																						
Code	Description	Image	Code	Description	Kit components																																																																				
OB1109A	XEVC-0511-E RIGHT INT DOOR COLUMN		KDR1269A	BT-04 EXTERNAL RIGHT DOOR	<table border="1"> <thead> <tr> <th>Code</th> <th>Description</th> <th>Qty</th> <th>UOM</th> </tr> </thead> <tbody> <tr> <td>CE1053B0</td> <td>MM MICROFIT LED BAR POWER SUPPLY CABL</td> <td>1.000</td> <td>PC</td> </tr> <tr> <td>CE1285A0</td> <td>EMI ROUND FERRITE MOD.26438015 02</td> <td>1.000</td> <td>PC</td> </tr> <tr> <td>CE1290A0</td> <td>EXTRACTABL E FEMALE TERMINAL CPF 5/4</td> <td>1.000</td> <td>PC</td> </tr> <tr> <td>CE1310A1</td> <td>POWER - CONTROL BOARD CONNECTING CABLE</td> <td>1.000</td> <td>PC</td> </tr> <tr> <td>LP1019A0</td> <td>6 SERIES L200 LED LIGHT BAR - E415</td> <td>1.000</td> <td>PC</td> </tr> <tr> <td>LP1025A0</td> <td>L=415 LED LIGHT BAR COVER</td> <td>1.000</td> <td>PC</td> </tr> <tr> <td>MG1083A2</td> <td>MM COMPLETE HANDLE</td> <td>1.000</td> <td>PC</td> </tr> <tr> <td>SL1170A1</td> <td>S57 BLACK SILICON - 310ml CARTRIDGE</td> <td>30.000</td> <td>ML</td> </tr> <tr> <td>VE1030A1</td> <td>MAGNET FOR DOOR MICROSWITC H D=22,9mm</td> <td>1.000</td> <td>PC</td> </tr> <tr> <td>VH1147A0</td> <td>5X25 STAINLESS STEEL SCREW</td> <td>16.000</td> <td>PC</td> </tr> <tr> <td>VH1220A1</td> <td>4,2x12 TCB SELF-TAPPIN G SCREW</td> <td>25.000</td> <td>PC</td> </tr> <tr> <td>VH1996A0</td> <td>M5x35 SCREW</td> <td>13.000</td> <td>PC</td> </tr> <tr> <td>VM1630A1</td> <td>INTERNAL GLASS PUSHING CAP</td> <td>3.000</td> <td>PC</td> </tr> <tr> <td>VM1631A0</td> <td>PLUS INNER GLASS PUSHING CAP</td> <td>2.000</td> <td>PC</td> </tr> <tr> <td>VM2259A1</td> <td>6 SERIES DOOR LOWER LEFT CAP</td> <td>1.000</td> <td>PC</td> </tr> <tr> <td>VM2260A1</td> <td>6 SERIES DOOR UPPER LEFT CAP</td> <td>1.000</td> <td>PC</td> </tr> </tbody> </table>	Code	Description	Qty	UOM	CE1053B0	MM MICROFIT LED BAR POWER SUPPLY CABL	1.000	PC	CE1285A0	EMI ROUND FERRITE MOD.26438015 02	1.000	PC	CE1290A0	EXTRACTABL E FEMALE TERMINAL CPF 5/4	1.000	PC	CE1310A1	POWER - CONTROL BOARD CONNECTING CABLE	1.000	PC	LP1019A0	6 SERIES L200 LED LIGHT BAR - E415	1.000	PC	LP1025A0	L=415 LED LIGHT BAR COVER	1.000	PC	MG1083A2	MM COMPLETE HANDLE	1.000	PC	SL1170A1	S57 BLACK SILICON - 310ml CARTRIDGE	30.000	ML	VE1030A1	MAGNET FOR DOOR MICROSWITC H D=22,9mm	1.000	PC	VH1147A0	5X25 STAINLESS STEEL SCREW	16.000	PC	VH1220A1	4,2x12 TCB SELF-TAPPIN G SCREW	25.000	PC	VH1996A0	M5x35 SCREW	13.000	PC	VM1630A1	INTERNAL GLASS PUSHING CAP	3.000	PC	VM1631A0	PLUS INNER GLASS PUSHING CAP	2.000	PC	VM2259A1	6 SERIES DOOR LOWER LEFT CAP	1.000	PC	VM2260A1	6 SERIES DOOR UPPER LEFT CAP	1.000	PC
Code	Description	Qty	UOM																																																																						
CE1053B0	MM MICROFIT LED BAR POWER SUPPLY CABL	1.000	PC																																																																						
CE1285A0	EMI ROUND FERRITE MOD.26438015 02	1.000	PC																																																																						
CE1290A0	EXTRACTABL E FEMALE TERMINAL CPF 5/4	1.000	PC																																																																						
CE1310A1	POWER - CONTROL BOARD CONNECTING CABLE	1.000	PC																																																																						
LP1019A0	6 SERIES L200 LED LIGHT BAR - E415	1.000	PC																																																																						
LP1025A0	L=415 LED LIGHT BAR COVER	1.000	PC																																																																						
MG1083A2	MM COMPLETE HANDLE	1.000	PC																																																																						
SL1170A1	S57 BLACK SILICON - 310ml CARTRIDGE	30.000	ML																																																																						
VE1030A1	MAGNET FOR DOOR MICROSWITC H D=22,9mm	1.000	PC																																																																						
VH1147A0	5X25 STAINLESS STEEL SCREW	16.000	PC																																																																						
VH1220A1	4,2x12 TCB SELF-TAPPIN G SCREW	25.000	PC																																																																						
VH1996A0	M5x35 SCREW	13.000	PC																																																																						
VM1630A1	INTERNAL GLASS PUSHING CAP	3.000	PC																																																																						
VM1631A0	PLUS INNER GLASS PUSHING CAP	2.000	PC																																																																						
VM2259A1	6 SERIES DOOR LOWER LEFT CAP	1.000	PC																																																																						
VM2260A1	6 SERIES DOOR UPPER LEFT CAP	1.000	PC																																																																						



COMPONENT			SPARE PART					
Code	Description	Image	Code	Description	Kit components			
OB1109A	XEVC-0511-E RIGHT INT DOOR COLUMN		KDR1269A	BT-04 EXTERNAL RIGHT DOOR	Code	Description	Qty	UOM
					VM2261A1	MM DOOR LOWER RIGHT CAP	1.000	PC
					VM2262A1	MM DOOR UPPER RIGHT CAP	1.000	PC
					VM2267A0	INTERNAL GLASS LOCKING SYSTEM SLIDER	2.000	PC
					VM2268A0	DOOR MAGNET COVER	2.000	PC
					VM2269A0	INTERNAL GLASS LOCKING SYSTEM CAP	2.000	PC
					VM2274A0	GROOVED BUSHING	1.000	PC
					VM2275A0	SMOOTH BUSHING	1.000	PC
					VM2285A0	860 SERIES DRIP PROFILE	1.000	PC
					VM2305A0	MM SERIES DOOR CAP FIXING PAWL	14.000	PC
					VM2312A0	MM DRIP PROFILE DRAIN LEFT PIPE	1.000	PC
					VM2313A0	MM DRIP TRAY RIGHT DRAIN PIPE	1.000	PC
					VM2314A0	MM DRIP PROFILE CAP	1.000	PC
					VM2315A0	MIND.Maps INTERNAL GLASS CAP SUPPORT	3.000	PC
					VM2505A0	MM PLUS INTERNAL GLASS SUPPORT	2.000	PC
					VM2518A0	BOARD COOLING FAN SUPPORT	1.000	PC
					VN1179A1	CONTROL BOARD 40x40x20mm 12V COOLING FAN	1.000	PC
					VT1290A0	EXTERNAL GLASS XEBC-04EU-E	1.000	PC



COMPONENT			SPARE PART																																																																		
Code	Description	Image	Code	Description	Kit components																																																																
OB1109A	XEVC-0511-E RIGHT INT DOOR COLUMN		KDR1261B	0511 -M RIGHT EXTERNAL DOOR	<table border="1"> <thead> <tr> <th>Code</th> <th>Description</th> <th>Qty</th> <th>UOM</th> </tr> </thead> <tbody> <tr> <td>OB1106A0</td> <td>XEVC-0511-E DOOR EXTERNAL LEFT COLUMN</td> <td>1.000</td> <td>PC</td> </tr> <tr> <td>OB1107A1</td> <td>XEVC-0511-E LEFT INT DOOR COLUM</td> <td>1.000</td> <td>PC</td> </tr> <tr> <td>OB1108B1</td> <td>XEVC-0511 DOOR EXTERNAL RIGHT COLUM</td> <td>1.000</td> <td>PC</td> </tr> <tr> <td>OB1109A1</td> <td>XEVC-0511-E RIGHT INT DOOR COLUM</td> <td>1.000</td> <td>PC</td> </tr> <tr> <td>OB1122B0</td> <td>MM CT 750mm DOOR LOWER BEAM</td> <td>1.000</td> <td>PC</td> </tr> <tr> <td>OB1166A1</td> <td>XEVC-0511-E EXT GLASS SUPPORT PROFILE</td> <td>2.000</td> <td>PC</td> </tr> <tr> <td>OB1216B0</td> <td>MM DOUBLE GLASS DOOR 750mm UPPER BEAM</td> <td>1.000</td> <td>PC</td> </tr> <tr> <td>OB1217A1</td> <td>MM DOUBLE GLASS DOOR INT UPPER BEAM 750</td> <td>1.000</td> <td>PC</td> </tr> <tr> <td>CE1052A1</td> <td>MM USB-CONTRO L PANEL CONNECTING CABLE</td> <td>1.000</td> <td>PC</td> </tr> <tr> <td>CE1053B0</td> <td>MM MICROFIT LED BAR POWER SUPPLY CABL</td> <td>1.000</td> <td>PC</td> </tr> <tr> <td>CE1096A0</td> <td>4 POLES MICROFIT 3 M BUS CABLE</td> <td>1.000</td> <td>PC</td> </tr> <tr> <td>CE1285A0</td> <td>EMI ROUND FERRITE MOD.26438015 02</td> <td>2.000</td> <td>PC</td> </tr> <tr> <td>GN1525A0</td> <td>O-RING INT DIAM 9,5 THK 1 NBR 70</td> <td>1.000</td> <td>PC</td> </tr> <tr> <td>LP1019A0</td> <td>6 SERIES L200 LED LIGHT BAR - E415</td> <td>1.000</td> <td>PC</td> </tr> <tr> <td>LP1025A0</td> <td>L=415 LED LIGHT BAR COVER</td> <td>1.000</td> <td>PC</td> </tr> </tbody> </table>	Code	Description	Qty	UOM	OB1106A0	XEVC-0511-E DOOR EXTERNAL LEFT COLUMN	1.000	PC	OB1107A1	XEVC-0511-E LEFT INT DOOR COLUM	1.000	PC	OB1108B1	XEVC-0511 DOOR EXTERNAL RIGHT COLUM	1.000	PC	OB1109A1	XEVC-0511-E RIGHT INT DOOR COLUM	1.000	PC	OB1122B0	MM CT 750mm DOOR LOWER BEAM	1.000	PC	OB1166A1	XEVC-0511-E EXT GLASS SUPPORT PROFILE	2.000	PC	OB1216B0	MM DOUBLE GLASS DOOR 750mm UPPER BEAM	1.000	PC	OB1217A1	MM DOUBLE GLASS DOOR INT UPPER BEAM 750	1.000	PC	CE1052A1	MM USB-CONTRO L PANEL CONNECTING CABLE	1.000	PC	CE1053B0	MM MICROFIT LED BAR POWER SUPPLY CABL	1.000	PC	CE1096A0	4 POLES MICROFIT 3 M BUS CABLE	1.000	PC	CE1285A0	EMI ROUND FERRITE MOD.26438015 02	2.000	PC	GN1525A0	O-RING INT DIAM 9,5 THK 1 NBR 70	1.000	PC	LP1019A0	6 SERIES L200 LED LIGHT BAR - E415	1.000	PC	LP1025A0	L=415 LED LIGHT BAR COVER	1.000	PC
					Code	Description	Qty	UOM																																																													
					OB1106A0	XEVC-0511-E DOOR EXTERNAL LEFT COLUMN	1.000	PC																																																													
					OB1107A1	XEVC-0511-E LEFT INT DOOR COLUM	1.000	PC																																																													
					OB1108B1	XEVC-0511 DOOR EXTERNAL RIGHT COLUM	1.000	PC																																																													
					OB1109A1	XEVC-0511-E RIGHT INT DOOR COLUM	1.000	PC																																																													
					OB1122B0	MM CT 750mm DOOR LOWER BEAM	1.000	PC																																																													
					OB1166A1	XEVC-0511-E EXT GLASS SUPPORT PROFILE	2.000	PC																																																													
					OB1216B0	MM DOUBLE GLASS DOOR 750mm UPPER BEAM	1.000	PC																																																													
					OB1217A1	MM DOUBLE GLASS DOOR INT UPPER BEAM 750	1.000	PC																																																													
					CE1052A1	MM USB-CONTRO L PANEL CONNECTING CABLE	1.000	PC																																																													
					CE1053B0	MM MICROFIT LED BAR POWER SUPPLY CABL	1.000	PC																																																													
					CE1096A0	4 POLES MICROFIT 3 M BUS CABLE	1.000	PC																																																													
					CE1285A0	EMI ROUND FERRITE MOD.26438015 02	2.000	PC																																																													
					GN1525A0	O-RING INT DIAM 9,5 THK 1 NBR 70	1.000	PC																																																													
LP1019A0	6 SERIES L200 LED LIGHT BAR - E415	1.000	PC																																																																		
LP1025A0	L=415 LED LIGHT BAR COVER	1.000	PC																																																																		



COMPONENT			SPARE PART																																																																			
Code	Description	Image	Code	Description	Kit components																																																																	
OB1109A	XEVC-0511-E RIGHT INT DOOR COLUMN		KDR1261B	0511 -M RIGHT EXTERNAL DOOR	<table border="1"> <thead> <tr> <th>Code</th> <th>Description</th> <th>Qty</th> <th>UOM</th> </tr> </thead> <tbody> <tr> <td>MG1099A1</td> <td>MM COMPLETE HANDLE</td> <td>1.000</td> <td>PC</td> </tr> <tr> <td>RC1200A0</td> <td>ED=4 WIRE D=0.5 H24 COMPRESSIO N SPRING</td> <td>4.000</td> <td>PC</td> </tr> <tr> <td>SL1170A1</td> <td>S57 BLACK SILICON - 310ml CARTRIDGE</td> <td>30.000</td> <td>ML</td> </tr> <tr> <td>SL1221A0</td> <td>GN1/1 EXTERNAL GLASS UPPER SILICONE</td> <td>1.000</td> <td>PC</td> </tr> <tr> <td>SL1222A0</td> <td>0511 EXTERNAL GLASS LATERAL SILICONE</td> <td>4.000</td> <td>PC</td> </tr> <tr> <td>VE1030A1</td> <td>MAGNET FOR DOOR MICROSWITC H D=22,9mm</td> <td>1.000</td> <td>PC</td> </tr> <tr> <td>VI0239A1</td> <td>SELF-TAPPIN G SCREW 4,2X25 TCB+ INOX</td> <td>4.000</td> <td>PC</td> </tr> <tr> <td>VI1034A0</td> <td>STAINLESS STEEL WASHER 8,4x16x1</td> <td>1.000</td> <td>PC</td> </tr> <tr> <td>VI1074A0</td> <td>4X16 SCREW FOR PLASTIC</td> <td>2.000</td> <td>PC</td> </tr> <tr> <td>VI1103A0</td> <td>40X12 TBSP SCREW FOR PLASTIC</td> <td>2.000</td> <td>PC</td> </tr> <tr> <td>VI1220A1</td> <td>4,2x12 TCB SELF-TAPPIN G SCREW</td> <td>26.000</td> <td>PC</td> </tr> <tr> <td>VI1930A1</td> <td>5x20 ST. STEEL CHIP SCREW</td> <td>16.000</td> <td>PC</td> </tr> <tr> <td>VI1996A0</td> <td>M5x35 SCREW</td> <td>13.000</td> <td>PC</td> </tr> <tr> <td>VI2070A0</td> <td>SHEETTRACS TCB+ 40x8 SELF-THREAD SCREW</td> <td>6.000</td> <td>PC</td> </tr> <tr> <td>VM1490A0</td> <td>CHEFTOP/BAK ERTOP HANDLE SCREWS COVER</td> <td>2.000</td> <td>PC</td> </tr> </tbody> </table>	Code	Description	Qty	UOM	MG1099A1	MM COMPLETE HANDLE	1.000	PC	RC1200A0	ED=4 WIRE D=0.5 H24 COMPRESSIO N SPRING	4.000	PC	SL1170A1	S57 BLACK SILICON - 310ml CARTRIDGE	30.000	ML	SL1221A0	GN1/1 EXTERNAL GLASS UPPER SILICONE	1.000	PC	SL1222A0	0511 EXTERNAL GLASS LATERAL SILICONE	4.000	PC	VE1030A1	MAGNET FOR DOOR MICROSWITC H D=22,9mm	1.000	PC	VI0239A1	SELF-TAPPIN G SCREW 4,2X25 TCB+ INOX	4.000	PC	VI1034A0	STAINLESS STEEL WASHER 8,4x16x1	1.000	PC	VI1074A0	4X16 SCREW FOR PLASTIC	2.000	PC	VI1103A0	40X12 TBSP SCREW FOR PLASTIC	2.000	PC	VI1220A1	4,2x12 TCB SELF-TAPPIN G SCREW	26.000	PC	VI1930A1	5x20 ST. STEEL CHIP SCREW	16.000	PC	VI1996A0	M5x35 SCREW	13.000	PC	VI2070A0	SHEETTRACS TCB+ 40x8 SELF-THREAD SCREW	6.000	PC	VM1490A0	CHEFTOP/BAK ERTOP HANDLE SCREWS COVER	2.000	PC	
Code	Description	Qty	UOM																																																																			
MG1099A1	MM COMPLETE HANDLE	1.000	PC																																																																			
RC1200A0	ED=4 WIRE D=0.5 H24 COMPRESSIO N SPRING	4.000	PC																																																																			
SL1170A1	S57 BLACK SILICON - 310ml CARTRIDGE	30.000	ML																																																																			
SL1221A0	GN1/1 EXTERNAL GLASS UPPER SILICONE	1.000	PC																																																																			
SL1222A0	0511 EXTERNAL GLASS LATERAL SILICONE	4.000	PC																																																																			
VE1030A1	MAGNET FOR DOOR MICROSWITC H D=22,9mm	1.000	PC																																																																			
VI0239A1	SELF-TAPPIN G SCREW 4,2X25 TCB+ INOX	4.000	PC																																																																			
VI1034A0	STAINLESS STEEL WASHER 8,4x16x1	1.000	PC																																																																			
VI1074A0	4X16 SCREW FOR PLASTIC	2.000	PC																																																																			
VI1103A0	40X12 TBSP SCREW FOR PLASTIC	2.000	PC																																																																			
VI1220A1	4,2x12 TCB SELF-TAPPIN G SCREW	26.000	PC																																																																			
VI1930A1	5x20 ST. STEEL CHIP SCREW	16.000	PC																																																																			
VI1996A0	M5x35 SCREW	13.000	PC																																																																			
VI2070A0	SHEETTRACS TCB+ 40x8 SELF-THREAD SCREW	6.000	PC																																																																			
VM1490A0	CHEFTOP/BAK ERTOP HANDLE SCREWS COVER	2.000	PC																																																																			



COMPONENT			SPARE PART																																																																															
Code	Description	Image	Code	Description	Kit components																																																																													
OB1109A	XEVC-0511-E RIGHT INT DOOR COLUMN		KDR1261B	0511 -M RIGHT EXTERNAL DOOR	<table border="1"> <thead> <tr> <th>Code</th> <th>Description</th> <th>Qty</th> <th>UOM</th> </tr> </thead> <tbody> <tr> <td>VM1630A1</td> <td>INTERNAL GLASS PUSHING CAP</td> <td>3.000</td> <td>PC</td> </tr> <tr> <td>VM1631A0</td> <td>PLUS INNER GLASS PUSHING CAP</td> <td>3.000</td> <td>PC</td> </tr> <tr> <td>VM2259B0</td> <td>VM2259B0</td> <td>1.000</td> <td>PC</td> </tr> <tr> <td>VM2260B0</td> <td>S6 LEFT UPPER CAP</td> <td>1.000</td> <td>PC</td> </tr> <tr> <td>VM2261B0</td> <td>MM -M DOOR RIGHT LOWER CAP</td> <td>1.000</td> <td>PC</td> </tr> <tr> <td>VM2262B0</td> <td>MM -M DOOR RIGHT UPPER CAP</td> <td>1.000</td> <td>PC</td> </tr> <tr> <td>VM2267A0</td> <td>INTERNAL GLASS LOCKING SYSTEM SLIDER</td> <td>2.000</td> <td>PC</td> </tr> <tr> <td>VM2268A0</td> <td>DOOR MAGNET COVER</td> <td>2.000</td> <td>PC</td> </tr> <tr> <td>VM2269B0</td> <td>INNER GLASS FIXING CAP</td> <td>2.000</td> <td>PC</td> </tr> <tr> <td>VM2274A0</td> <td>GROOVED BUSHING</td> <td>1.000</td> <td>PC</td> </tr> <tr> <td>VM2275A0</td> <td>SMOOTH BUSHING</td> <td>1.000</td> <td>PC</td> </tr> <tr> <td>VM2284B0</td> <td>750 SERIES DRIP PROFILE KIT</td> <td>1.000</td> <td>PC</td> </tr> <tr> <td>VM2305A0</td> <td>MM SERIES DOOR CAP FIXING PAWL</td> <td>14.000</td> <td>PC</td> </tr> <tr> <td>VM2312A0</td> <td>MM DRIP PROFILE DRAIN LEFT PIPE</td> <td>1.000</td> <td>PC</td> </tr> <tr> <td>VM2314A0</td> <td>MM DRIP PROFILE CAP</td> <td>1.000</td> <td>PC</td> </tr> <tr> <td>VM2315B0</td> <td>S6 INTERNAL GLASS SUPPORT</td> <td>3.000</td> <td>PC</td> </tr> <tr> <td>VM2505B1</td> <td>MM PLUS INTERNAL GLASS SUPPORT</td> <td>3.000</td> <td>PC</td> </tr> <tr> <td>VP1080A0</td> <td>UPPER HINGE CAP FOR LOWER INNER GLASS</td> <td>1.000</td> <td>PC</td> </tr> </tbody> </table>	Code	Description	Qty	UOM	VM1630A1	INTERNAL GLASS PUSHING CAP	3.000	PC	VM1631A0	PLUS INNER GLASS PUSHING CAP	3.000	PC	VM2259B0	VM2259B0	1.000	PC	VM2260B0	S6 LEFT UPPER CAP	1.000	PC	VM2261B0	MM -M DOOR RIGHT LOWER CAP	1.000	PC	VM2262B0	MM -M DOOR RIGHT UPPER CAP	1.000	PC	VM2267A0	INTERNAL GLASS LOCKING SYSTEM SLIDER	2.000	PC	VM2268A0	DOOR MAGNET COVER	2.000	PC	VM2269B0	INNER GLASS FIXING CAP	2.000	PC	VM2274A0	GROOVED BUSHING	1.000	PC	VM2275A0	SMOOTH BUSHING	1.000	PC	VM2284B0	750 SERIES DRIP PROFILE KIT	1.000	PC	VM2305A0	MM SERIES DOOR CAP FIXING PAWL	14.000	PC	VM2312A0	MM DRIP PROFILE DRAIN LEFT PIPE	1.000	PC	VM2314A0	MM DRIP PROFILE CAP	1.000	PC	VM2315B0	S6 INTERNAL GLASS SUPPORT	3.000	PC	VM2505B1	MM PLUS INTERNAL GLASS SUPPORT	3.000	PC	VP1080A0	UPPER HINGE CAP FOR LOWER INNER GLASS	1.000	PC	
Code	Description	Qty	UOM																																																																															
VM1630A1	INTERNAL GLASS PUSHING CAP	3.000	PC																																																																															
VM1631A0	PLUS INNER GLASS PUSHING CAP	3.000	PC																																																																															
VM2259B0	VM2259B0	1.000	PC																																																																															
VM2260B0	S6 LEFT UPPER CAP	1.000	PC																																																																															
VM2261B0	MM -M DOOR RIGHT LOWER CAP	1.000	PC																																																																															
VM2262B0	MM -M DOOR RIGHT UPPER CAP	1.000	PC																																																																															
VM2267A0	INTERNAL GLASS LOCKING SYSTEM SLIDER	2.000	PC																																																																															
VM2268A0	DOOR MAGNET COVER	2.000	PC																																																																															
VM2269B0	INNER GLASS FIXING CAP	2.000	PC																																																																															
VM2274A0	GROOVED BUSHING	1.000	PC																																																																															
VM2275A0	SMOOTH BUSHING	1.000	PC																																																																															
VM2284B0	750 SERIES DRIP PROFILE KIT	1.000	PC																																																																															
VM2305A0	MM SERIES DOOR CAP FIXING PAWL	14.000	PC																																																																															
VM2312A0	MM DRIP PROFILE DRAIN LEFT PIPE	1.000	PC																																																																															
VM2314A0	MM DRIP PROFILE CAP	1.000	PC																																																																															
VM2315B0	S6 INTERNAL GLASS SUPPORT	3.000	PC																																																																															
VM2505B1	MM PLUS INTERNAL GLASS SUPPORT	3.000	PC																																																																															
VP1080A0	UPPER HINGE CAP FOR LOWER INNER GLASS	1.000	PC																																																																															



COMPONENT			SPARE PART																																																			
Code	Description	Image	Code	Description	Kit components																																																	
OB1109A	XEVC-0511-E RIGHT INT DOOR COLUMN		KDR1261B	0511 -M RIGHT EXTERNAL DOOR	<table border="1"> <thead> <tr> <th>Code</th> <th>Description</th> <th>Qty</th> <th>UOM</th> </tr> </thead> <tbody> <tr> <td>VP1081A0</td> <td>UPPER HINGE CAP FOR UPPER INNER GLASS</td> <td>1.000</td> <td>PC</td> </tr> <tr> <td>VT1276A0</td> <td>XEVC-0511-E DOOR EXTERNAL GLASS</td> <td>1.000</td> <td>PC</td> </tr> </tbody> </table>	Code	Description	Qty	UOM	VP1081A0	UPPER HINGE CAP FOR UPPER INNER GLASS	1.000	PC	VT1276A0	XEVC-0511-E DOOR EXTERNAL GLASS	1.000	PC																																					
			Code	Description	Qty	UOM																																																
VP1081A0	UPPER HINGE CAP FOR UPPER INNER GLASS	1.000	PC																																																			
VT1276A0	XEVC-0511-E DOOR EXTERNAL GLASS	1.000	PC																																																			
KDR1261A	0511 RIGHT EXTERNAL DOOR	<table border="1"> <thead> <tr> <th>Code</th> <th>Description</th> <th>Qty</th> <th>UOM</th> </tr> </thead> <tbody> <tr> <td>OB1106A0</td> <td>XEVC-0511-E DOOR EXTERNAL LEFT COLUMN</td> <td>1.000</td> <td>PC</td> </tr> <tr> <td>OB1107A1</td> <td>XEVC-0511-E LEFT INT DOOR COLUM</td> <td>1.000</td> <td>PC</td> </tr> <tr> <td>OB1108B1</td> <td>XEVC-0511 DOOR EXTERNAL RIGHT COLUM</td> <td>1.000</td> <td>PC</td> </tr> <tr> <td>OB1109A1</td> <td>XEVC-0511-E RIGHT INT DOOR COLUM</td> <td>1.000</td> <td>PC</td> </tr> <tr> <td>OB1122A1</td> <td>750MM DOOR LOWER FRAME SHAPE</td> <td>1.000</td> <td>PC</td> </tr> <tr> <td>OB1166A1</td> <td>XEVC-0511-E EXT GLASS SUPPORT PROFILE</td> <td>2.000</td> <td>PC</td> </tr> <tr> <td>OB1216A1</td> <td>MM CT DOUBLE GLASS DOOR UPPER BEAM</td> <td>1.000</td> <td>PC</td> </tr> <tr> <td>OB1217A1</td> <td>MM DOUBLE GLASS DOOR INT UPPER BEAM 750</td> <td>1.000</td> <td>PC</td> </tr> <tr> <td>CE1052A1</td> <td>MM USB-CONTRO L PANEL CONNECTING CABLE</td> <td>1.000</td> <td>PC</td> </tr> <tr> <td>CE1053B0</td> <td>MM MICROFIT LED BAR POWER SUPPLY CABL</td> <td>1.000</td> <td>PC</td> </tr> <tr> <td>CE1275A0</td> <td>3M POWER - CONTROL CONNECTION CABLE</td> <td>1.000</td> <td>PC</td> </tr> <tr> <td>CE1285A0</td> <td>EMI ROUND FERRITE MOD.26438015 02</td> <td>1.000</td> <td>PC</td> </tr> </tbody> </table>	Code	Description	Qty	UOM	OB1106A0	XEVC-0511-E DOOR EXTERNAL LEFT COLUMN	1.000	PC	OB1107A1	XEVC-0511-E LEFT INT DOOR COLUM	1.000	PC	OB1108B1	XEVC-0511 DOOR EXTERNAL RIGHT COLUM	1.000	PC	OB1109A1	XEVC-0511-E RIGHT INT DOOR COLUM	1.000	PC	OB1122A1	750MM DOOR LOWER FRAME SHAPE	1.000	PC	OB1166A1	XEVC-0511-E EXT GLASS SUPPORT PROFILE	2.000	PC	OB1216A1	MM CT DOUBLE GLASS DOOR UPPER BEAM	1.000	PC	OB1217A1	MM DOUBLE GLASS DOOR INT UPPER BEAM 750	1.000	PC	CE1052A1	MM USB-CONTRO L PANEL CONNECTING CABLE	1.000	PC	CE1053B0	MM MICROFIT LED BAR POWER SUPPLY CABL	1.000	PC	CE1275A0	3M POWER - CONTROL CONNECTION CABLE	1.000	PC	CE1285A0	EMI ROUND FERRITE MOD.26438015 02	1.000	PC
Code	Description	Qty	UOM																																																			
OB1106A0	XEVC-0511-E DOOR EXTERNAL LEFT COLUMN	1.000	PC																																																			
OB1107A1	XEVC-0511-E LEFT INT DOOR COLUM	1.000	PC																																																			
OB1108B1	XEVC-0511 DOOR EXTERNAL RIGHT COLUM	1.000	PC																																																			
OB1109A1	XEVC-0511-E RIGHT INT DOOR COLUM	1.000	PC																																																			
OB1122A1	750MM DOOR LOWER FRAME SHAPE	1.000	PC																																																			
OB1166A1	XEVC-0511-E EXT GLASS SUPPORT PROFILE	2.000	PC																																																			
OB1216A1	MM CT DOUBLE GLASS DOOR UPPER BEAM	1.000	PC																																																			
OB1217A1	MM DOUBLE GLASS DOOR INT UPPER BEAM 750	1.000	PC																																																			
CE1052A1	MM USB-CONTRO L PANEL CONNECTING CABLE	1.000	PC																																																			
CE1053B0	MM MICROFIT LED BAR POWER SUPPLY CABL	1.000	PC																																																			
CE1275A0	3M POWER - CONTROL CONNECTION CABLE	1.000	PC																																																			
CE1285A0	EMI ROUND FERRITE MOD.26438015 02	1.000	PC																																																			



COMPONENT			SPARE PART																																																																										
Code	Description	Image	Code	Description	Kit components																																																																								
OB1109A	XEVC-0511-E RIGHT INT DOOR COLUMN		KDR1261A	0511 RIGHT EXTERNAL DOOR	<table border="1"> <thead> <tr> <th>Code</th> <th>Description</th> <th>Qty</th> <th>UOM</th> </tr> </thead> <tbody> <tr> <td>CE1290A0</td> <td>EXTRACTABL E FEMALE TERMINAL CPF 5/4</td> <td>1.000</td> <td>PC</td> </tr> <tr> <td>GN1525A0</td> <td>O-RING INT DIAM 9,5 THK 1 NBR 70</td> <td>1.000</td> <td>PC</td> </tr> <tr> <td>LP1019A0</td> <td>6 SERIES L200 LED LIGHT BAR - E415</td> <td>1.000</td> <td>PC</td> </tr> <tr> <td>LP1025A0</td> <td>L=415 LED LIGHT BAR COVER</td> <td>1.000</td> <td>PC</td> </tr> <tr> <td>MG1083A2</td> <td>MM COMPLETE HANDLE</td> <td>1.000</td> <td>PC</td> </tr> <tr> <td>SL1170A1</td> <td>S57 BLACK SILICON - 310ml CARTRIDGE</td> <td>30.000</td> <td>ML</td> </tr> <tr> <td>VE1030A1</td> <td>MAGNET FOR DOOR MICROSWITC H D=22,9mm</td> <td>1.000</td> <td>PC</td> </tr> <tr> <td>VI1034A0</td> <td>STAINLESS STEEL WASHER 8,4x16x1</td> <td>1.000</td> <td>PC</td> </tr> <tr> <td>VI1147A0</td> <td>5X25 STAINLESS STEEL SCREW</td> <td>16.000</td> <td>PC</td> </tr> <tr> <td>VI1220A1</td> <td>4,2x12 TCB SELF-TAPPIN G SCREW</td> <td>25.000</td> <td>PC</td> </tr> <tr> <td>VI1996A0</td> <td>M5x35 SCREW</td> <td>13.000</td> <td>PC</td> </tr> <tr> <td>VM1630A1</td> <td>INTERNAL GLASS PUSHING CAP</td> <td>3.000</td> <td>PC</td> </tr> <tr> <td>VM1631A0</td> <td>PLUS INNER GLASS PUSHING CAP</td> <td>2.000</td> <td>PC</td> </tr> <tr> <td>VM2259A1</td> <td>6 SERIES DOOR LOWER LEFT CAP</td> <td>1.000</td> <td>PC</td> </tr> <tr> <td>VM2260A1</td> <td>6 SERIES DOOR UPPER LEFT CAP</td> <td>1.000</td> <td>PC</td> </tr> <tr> <td>VM2261A1</td> <td>MM DOOR LOWER RIGHT CAP</td> <td>1.000</td> <td>PC</td> </tr> <tr> <td>VM2262A1</td> <td>MM DOOR UPPER RIGHT CAP</td> <td>1.000</td> <td>PC</td> </tr> </tbody> </table>	Code	Description	Qty	UOM	CE1290A0	EXTRACTABL E FEMALE TERMINAL CPF 5/4	1.000	PC	GN1525A0	O-RING INT DIAM 9,5 THK 1 NBR 70	1.000	PC	LP1019A0	6 SERIES L200 LED LIGHT BAR - E415	1.000	PC	LP1025A0	L=415 LED LIGHT BAR COVER	1.000	PC	MG1083A2	MM COMPLETE HANDLE	1.000	PC	SL1170A1	S57 BLACK SILICON - 310ml CARTRIDGE	30.000	ML	VE1030A1	MAGNET FOR DOOR MICROSWITC H D=22,9mm	1.000	PC	VI1034A0	STAINLESS STEEL WASHER 8,4x16x1	1.000	PC	VI1147A0	5X25 STAINLESS STEEL SCREW	16.000	PC	VI1220A1	4,2x12 TCB SELF-TAPPIN G SCREW	25.000	PC	VI1996A0	M5x35 SCREW	13.000	PC	VM1630A1	INTERNAL GLASS PUSHING CAP	3.000	PC	VM1631A0	PLUS INNER GLASS PUSHING CAP	2.000	PC	VM2259A1	6 SERIES DOOR LOWER LEFT CAP	1.000	PC	VM2260A1	6 SERIES DOOR UPPER LEFT CAP	1.000	PC	VM2261A1	MM DOOR LOWER RIGHT CAP	1.000	PC	VM2262A1	MM DOOR UPPER RIGHT CAP	1.000	PC
					Code	Description	Qty	UOM																																																																					
					CE1290A0	EXTRACTABL E FEMALE TERMINAL CPF 5/4	1.000	PC																																																																					
					GN1525A0	O-RING INT DIAM 9,5 THK 1 NBR 70	1.000	PC																																																																					
					LP1019A0	6 SERIES L200 LED LIGHT BAR - E415	1.000	PC																																																																					
					LP1025A0	L=415 LED LIGHT BAR COVER	1.000	PC																																																																					
					MG1083A2	MM COMPLETE HANDLE	1.000	PC																																																																					
					SL1170A1	S57 BLACK SILICON - 310ml CARTRIDGE	30.000	ML																																																																					
					VE1030A1	MAGNET FOR DOOR MICROSWITC H D=22,9mm	1.000	PC																																																																					
					VI1034A0	STAINLESS STEEL WASHER 8,4x16x1	1.000	PC																																																																					
					VI1147A0	5X25 STAINLESS STEEL SCREW	16.000	PC																																																																					
					VI1220A1	4,2x12 TCB SELF-TAPPIN G SCREW	25.000	PC																																																																					
					VI1996A0	M5x35 SCREW	13.000	PC																																																																					
					VM1630A1	INTERNAL GLASS PUSHING CAP	3.000	PC																																																																					
					VM1631A0	PLUS INNER GLASS PUSHING CAP	2.000	PC																																																																					
					VM2259A1	6 SERIES DOOR LOWER LEFT CAP	1.000	PC																																																																					
					VM2260A1	6 SERIES DOOR UPPER LEFT CAP	1.000	PC																																																																					
VM2261A1	MM DOOR LOWER RIGHT CAP	1.000	PC																																																																										
VM2262A1	MM DOOR UPPER RIGHT CAP	1.000	PC																																																																										



COMPONENT			SPARE PART																																																														
Code	Description	Image	Code	Description	Kit components																																																												
OB1109A	XEVC-0511-E RIGHT INT DOOR COLUMN		KDR1261A	0511 RIGHT EXTERNAL DOOR	<table border="1"> <thead> <tr> <th>Code</th> <th>Description</th> <th>Qty</th> <th>UOM</th> </tr> </thead> <tbody> <tr> <td>VM2267A0</td> <td>INTERNAL GLASS LOCKING SYSTEM SLIDER</td> <td>2.000</td> <td>PC</td> </tr> <tr> <td>VM2268A0</td> <td>DOOR MAGNET COVER</td> <td>2.000</td> <td>PC</td> </tr> <tr> <td>VM2269A0</td> <td>INTERNAL GLASS LOCKING SYSTEM CAP</td> <td>2.000</td> <td>PC</td> </tr> <tr> <td>VM2274A0</td> <td>GROOVED BUSHING</td> <td>1.000</td> <td>PC</td> </tr> <tr> <td>VM2275A0</td> <td>SMOOTH BUSHING</td> <td>1.000</td> <td>PC</td> </tr> <tr> <td>VM2284A0</td> <td>750 SERIES DRIP PROFILE</td> <td>1.000</td> <td>PC</td> </tr> <tr> <td>VM2305A0</td> <td>MM SERIES DOOR CAP FIXING PAWL</td> <td>14.000</td> <td>PC</td> </tr> <tr> <td>VM2312A0</td> <td>MM DRIP PROFILE DRAIN LEFT PIPE</td> <td>1.000</td> <td>PC</td> </tr> <tr> <td>VM2314A0</td> <td>MM DRIP PROFILE CAP</td> <td>1.000</td> <td>PC</td> </tr> <tr> <td>VM2315A0</td> <td>MIND.Maps INTERNAL GLASS CAP SUPPORT</td> <td>3.000</td> <td>PC</td> </tr> <tr> <td>VM2505A0</td> <td>MM PLUS INTERNAL GLASS SUPPORT</td> <td>2.000</td> <td>PC</td> </tr> <tr> <td>VM2518A0</td> <td>BOARD COOLING FAN SUPPORT</td> <td>1.000</td> <td>PC</td> </tr> <tr> <td>VN1179A1</td> <td>CONTROL BOARD 40x40x20mm 12V COOLING FAN</td> <td>1.000</td> <td>PC</td> </tr> <tr> <td>VT1276A0</td> <td>XEVC-0511-E DOOR EXTERNAL GLASS</td> <td>1.000</td> <td>PC</td> </tr> </tbody> </table>	Code	Description	Qty	UOM	VM2267A0	INTERNAL GLASS LOCKING SYSTEM SLIDER	2.000	PC	VM2268A0	DOOR MAGNET COVER	2.000	PC	VM2269A0	INTERNAL GLASS LOCKING SYSTEM CAP	2.000	PC	VM2274A0	GROOVED BUSHING	1.000	PC	VM2275A0	SMOOTH BUSHING	1.000	PC	VM2284A0	750 SERIES DRIP PROFILE	1.000	PC	VM2305A0	MM SERIES DOOR CAP FIXING PAWL	14.000	PC	VM2312A0	MM DRIP PROFILE DRAIN LEFT PIPE	1.000	PC	VM2314A0	MM DRIP PROFILE CAP	1.000	PC	VM2315A0	MIND.Maps INTERNAL GLASS CAP SUPPORT	3.000	PC	VM2505A0	MM PLUS INTERNAL GLASS SUPPORT	2.000	PC	VM2518A0	BOARD COOLING FAN SUPPORT	1.000	PC	VN1179A1	CONTROL BOARD 40x40x20mm 12V COOLING FAN	1.000	PC	VT1276A0	XEVC-0511-E DOOR EXTERNAL GLASS	1.000	PC
Code	Description	Qty	UOM																																																														
VM2267A0	INTERNAL GLASS LOCKING SYSTEM SLIDER	2.000	PC																																																														
VM2268A0	DOOR MAGNET COVER	2.000	PC																																																														
VM2269A0	INTERNAL GLASS LOCKING SYSTEM CAP	2.000	PC																																																														
VM2274A0	GROOVED BUSHING	1.000	PC																																																														
VM2275A0	SMOOTH BUSHING	1.000	PC																																																														
VM2284A0	750 SERIES DRIP PROFILE	1.000	PC																																																														
VM2305A0	MM SERIES DOOR CAP FIXING PAWL	14.000	PC																																																														
VM2312A0	MM DRIP PROFILE DRAIN LEFT PIPE	1.000	PC																																																														
VM2314A0	MM DRIP PROFILE CAP	1.000	PC																																																														
VM2315A0	MIND.Maps INTERNAL GLASS CAP SUPPORT	3.000	PC																																																														
VM2505A0	MM PLUS INTERNAL GLASS SUPPORT	2.000	PC																																																														
VM2518A0	BOARD COOLING FAN SUPPORT	1.000	PC																																																														
VN1179A1	CONTROL BOARD 40x40x20mm 12V COOLING FAN	1.000	PC																																																														
VT1276A0	XEVC-0511-E DOOR EXTERNAL GLASS	1.000	PC																																																														







COMPONENT			SPARE PART																																																																																					
Code	Description	Image	Code	Description	Kit components																																																																																			
0B1126B	860mm DOOR LOWER BEAM		K0B1126BR	BAKERTOP MM -M RIGHT DOOR LOWER BEAM KIT	<table border="1"> <thead> <tr> <th>Code</th> <th>Description</th> <th>Qty</th> <th>UOM</th> </tr> </thead> <tbody> <tr> <td>0B1126B0</td> <td>860mm DOOR LOWER BEAM</td> <td>1.000</td> <td>PC</td> </tr> <tr> <td>RC1200A0</td> <td>ED=4 WIRE D=0.5 H24 COMPRESSIO N SPRING</td> <td>2.000</td> <td>PC</td> </tr> <tr> <td>VE1030A1</td> <td>MAGNET FOR DOOR MICROSWITC H D=22.9mm</td> <td>1.000</td> <td>PC</td> </tr> <tr> <td>VI1103A0</td> <td>40X12 TBSP SCREW FOR PLASTIC</td> <td>1.000</td> <td>PC</td> </tr> <tr> <td>VI1220A1</td> <td>4.2x12 TCB SELF-TAPPIN G SCREW</td> <td>1.000</td> <td>PC</td> </tr> <tr> <td>VI1930A1</td> <td>5x20 ST. STEEL CHIP SCREW</td> <td>8.000</td> <td>PC</td> </tr> <tr> <td>VI1996A0</td> <td>M5x35 SCREW</td> <td>6.000</td> <td>PC</td> </tr> <tr> <td>VM1794A0</td> <td>250x4.8 PA66 BLACK CLAMP</td> <td>2.000</td> <td>PC</td> </tr> <tr> <td>VM2103A0</td> <td>CLAMP LOCK</td> <td>2.000</td> <td>PC</td> </tr> <tr> <td>VM2267A0</td> <td>INTERNAL GLASS LOCKING SYSTEM SLIDER</td> <td>1.000</td> <td>PC</td> </tr> <tr> <td>VM2268A0</td> <td>DOOR MAGNET COVER</td> <td>1.000</td> <td>PC</td> </tr> <tr> <td>VM2269B0</td> <td>INNER GLASS FIXING CAP</td> <td>1.000</td> <td>PC</td> </tr> <tr> <td>VM2274A0</td> <td>GROOVED BUSHING</td> <td>1.000</td> <td>PC</td> </tr> <tr> <td>VM2305A0</td> <td>MM SERIES DOOR CAP FIXING PAWL</td> <td>7.000</td> <td>PC</td> </tr> <tr> <td>VM2384B0</td> <td>MM LEFT DOOR RIGHT LOWER CAP</td> <td>1.000</td> <td>PC</td> </tr> <tr> <td>VM2386B0</td> <td>MM -M LEFT DOOR LEFT LOWER CAP KI</td> <td>1.000</td> <td>PC</td> </tr> <tr> <td>VP1081A0</td> <td>UPPER HINGE CAP FOR UPPER INNER GLASS</td> <td>1.000</td> <td>PC</td> </tr> </tbody> </table>	Code	Description	Qty	UOM	0B1126B0	860mm DOOR LOWER BEAM	1.000	PC	RC1200A0	ED=4 WIRE D=0.5 H24 COMPRESSIO N SPRING	2.000	PC	VE1030A1	MAGNET FOR DOOR MICROSWITC H D=22.9mm	1.000	PC	VI1103A0	40X12 TBSP SCREW FOR PLASTIC	1.000	PC	VI1220A1	4.2x12 TCB SELF-TAPPIN G SCREW	1.000	PC	VI1930A1	5x20 ST. STEEL CHIP SCREW	8.000	PC	VI1996A0	M5x35 SCREW	6.000	PC	VM1794A0	250x4.8 PA66 BLACK CLAMP	2.000	PC	VM2103A0	CLAMP LOCK	2.000	PC	VM2267A0	INTERNAL GLASS LOCKING SYSTEM SLIDER	1.000	PC	VM2268A0	DOOR MAGNET COVER	1.000	PC	VM2269B0	INNER GLASS FIXING CAP	1.000	PC	VM2274A0	GROOVED BUSHING	1.000	PC	VM2305A0	MM SERIES DOOR CAP FIXING PAWL	7.000	PC	VM2384B0	MM LEFT DOOR RIGHT LOWER CAP	1.000	PC	VM2386B0	MM -M LEFT DOOR LEFT LOWER CAP KI	1.000	PC	VP1081A0	UPPER HINGE CAP FOR UPPER INNER GLASS	1.000	PC	K0B1126BL	EU+2/1 MM -MLEFT DOOR LOWER BEAM KIT	<table border="1"> <thead> <tr> <th>Code</th> <th>Description</th> <th>Qty</th> <th>UOM</th> </tr> </thead> <tbody> <tr> <td>0B1126B0</td> <td>860mm DOOR LOWER BEAM</td> <td>1.000</td> <td>PC</td> </tr> </tbody> </table>	Code	Description	Qty	UOM	0B1126B0	860mm DOOR LOWER BEAM	1.000	PC
			Code	Description	Qty	UOM																																																																																		
0B1126B0	860mm DOOR LOWER BEAM	1.000	PC																																																																																					
RC1200A0	ED=4 WIRE D=0.5 H24 COMPRESSIO N SPRING	2.000	PC																																																																																					
VE1030A1	MAGNET FOR DOOR MICROSWITC H D=22.9mm	1.000	PC																																																																																					
VI1103A0	40X12 TBSP SCREW FOR PLASTIC	1.000	PC																																																																																					
VI1220A1	4.2x12 TCB SELF-TAPPIN G SCREW	1.000	PC																																																																																					
VI1930A1	5x20 ST. STEEL CHIP SCREW	8.000	PC																																																																																					
VI1996A0	M5x35 SCREW	6.000	PC																																																																																					
VM1794A0	250x4.8 PA66 BLACK CLAMP	2.000	PC																																																																																					
VM2103A0	CLAMP LOCK	2.000	PC																																																																																					
VM2267A0	INTERNAL GLASS LOCKING SYSTEM SLIDER	1.000	PC																																																																																					
VM2268A0	DOOR MAGNET COVER	1.000	PC																																																																																					
VM2269B0	INNER GLASS FIXING CAP	1.000	PC																																																																																					
VM2274A0	GROOVED BUSHING	1.000	PC																																																																																					
VM2305A0	MM SERIES DOOR CAP FIXING PAWL	7.000	PC																																																																																					
VM2384B0	MM LEFT DOOR RIGHT LOWER CAP	1.000	PC																																																																																					
VM2386B0	MM -M LEFT DOOR LEFT LOWER CAP KI	1.000	PC																																																																																					
VP1081A0	UPPER HINGE CAP FOR UPPER INNER GLASS	1.000	PC																																																																																					
Code	Description	Qty	UOM																																																																																					
0B1126B0	860mm DOOR LOWER BEAM	1.000	PC																																																																																					



COMPONENT			SPARE PART																																																																						
Code	Description	Image	Code	Description	Kit components																																																																				
0B1126B	860mm DOOR LOWER BEAM		K0B1126BL	EU+2/1 MM -MLEFT DOOR LOWER BEAM KIT	<table border="1"> <thead> <tr> <th>Code</th> <th>Description</th> <th>Qty</th> <th>UOM</th> </tr> </thead> <tbody> <tr> <td>RC1200A0</td> <td>ED=4 WIRE D=0.5 H24 COMPRESSIO N SPRING</td> <td>2.000</td> <td>PC</td> </tr> <tr> <td>VE1030A1</td> <td>MAGNET FOR DOOR MICROSWITC H D=22.9mm</td> <td>1.000</td> <td>PC</td> </tr> <tr> <td>VI1103A0</td> <td>40X12 TBSP SCREW FOR PLASTIC</td> <td>1.000</td> <td>PC</td> </tr> <tr> <td>VI1220A1</td> <td>4,2x12 TCB SELF-TAPPIN G SCREW</td> <td>1.000</td> <td>PC</td> </tr> <tr> <td>VI1930A1</td> <td>5x20 ST. STEEL CHIP SCREW</td> <td>8.000</td> <td>PC</td> </tr> <tr> <td>VI1996A0</td> <td>M5x35 SCREW</td> <td>6.000</td> <td>PC</td> </tr> <tr> <td>VM1794A0</td> <td>250x4.8 PA66 BLACK CLAMP</td> <td>2.000</td> <td>PC</td> </tr> <tr> <td>VM2103A0</td> <td>CLAMP LOCK</td> <td>2.000</td> <td>PC</td> </tr> <tr> <td>VM2267A0</td> <td>INTERNAL GLASS LOCKING SYSTEM SLIDER</td> <td>1.000</td> <td>PC</td> </tr> <tr> <td>VM2268A0</td> <td>DOOR MAGNET COVER</td> <td>1.000</td> <td>PC</td> </tr> <tr> <td>VM2269B0</td> <td>INNER GLASS FIXING CAP</td> <td>1.000</td> <td>PC</td> </tr> <tr> <td>VM2274A0</td> <td>GROOVED BUSHING</td> <td>1.000</td> <td>PC</td> </tr> <tr> <td>VM2305A0</td> <td>MM SERIES DOOR CAP FIXING PAWL</td> <td>7.000</td> <td>PC</td> </tr> <tr> <td>VM2384B0</td> <td>MM LEFT DOOR RIGHT LOWER CAP</td> <td>1.000</td> <td>PC</td> </tr> <tr> <td>VM2386B0</td> <td>MM -M LEFT DOOR LEFT LOWER CAP KI</td> <td>1.000</td> <td>PC</td> </tr> <tr> <td>VP1081A0</td> <td>UPPER HINGE CAP FOR UPPER INNER GLASS</td> <td>1.000</td> <td>PC</td> </tr> </tbody> </table>	Code	Description	Qty	UOM	RC1200A0	ED=4 WIRE D=0.5 H24 COMPRESSIO N SPRING	2.000	PC	VE1030A1	MAGNET FOR DOOR MICROSWITC H D=22.9mm	1.000	PC	VI1103A0	40X12 TBSP SCREW FOR PLASTIC	1.000	PC	VI1220A1	4,2x12 TCB SELF-TAPPIN G SCREW	1.000	PC	VI1930A1	5x20 ST. STEEL CHIP SCREW	8.000	PC	VI1996A0	M5x35 SCREW	6.000	PC	VM1794A0	250x4.8 PA66 BLACK CLAMP	2.000	PC	VM2103A0	CLAMP LOCK	2.000	PC	VM2267A0	INTERNAL GLASS LOCKING SYSTEM SLIDER	1.000	PC	VM2268A0	DOOR MAGNET COVER	1.000	PC	VM2269B0	INNER GLASS FIXING CAP	1.000	PC	VM2274A0	GROOVED BUSHING	1.000	PC	VM2305A0	MM SERIES DOOR CAP FIXING PAWL	7.000	PC	VM2384B0	MM LEFT DOOR RIGHT LOWER CAP	1.000	PC	VM2386B0	MM -M LEFT DOOR LEFT LOWER CAP KI	1.000	PC	VP1081A0	UPPER HINGE CAP FOR UPPER INNER GLASS	1.000	PC
Code	Description	Qty	UOM																																																																						
RC1200A0	ED=4 WIRE D=0.5 H24 COMPRESSIO N SPRING	2.000	PC																																																																						
VE1030A1	MAGNET FOR DOOR MICROSWITC H D=22.9mm	1.000	PC																																																																						
VI1103A0	40X12 TBSP SCREW FOR PLASTIC	1.000	PC																																																																						
VI1220A1	4,2x12 TCB SELF-TAPPIN G SCREW	1.000	PC																																																																						
VI1930A1	5x20 ST. STEEL CHIP SCREW	8.000	PC																																																																						
VI1996A0	M5x35 SCREW	6.000	PC																																																																						
VM1794A0	250x4.8 PA66 BLACK CLAMP	2.000	PC																																																																						
VM2103A0	CLAMP LOCK	2.000	PC																																																																						
VM2267A0	INTERNAL GLASS LOCKING SYSTEM SLIDER	1.000	PC																																																																						
VM2268A0	DOOR MAGNET COVER	1.000	PC																																																																						
VM2269B0	INNER GLASS FIXING CAP	1.000	PC																																																																						
VM2274A0	GROOVED BUSHING	1.000	PC																																																																						
VM2305A0	MM SERIES DOOR CAP FIXING PAWL	7.000	PC																																																																						
VM2384B0	MM LEFT DOOR RIGHT LOWER CAP	1.000	PC																																																																						
VM2386B0	MM -M LEFT DOOR LEFT LOWER CAP KI	1.000	PC																																																																						
VP1081A0	UPPER HINGE CAP FOR UPPER INNER GLASS	1.000	PC																																																																						

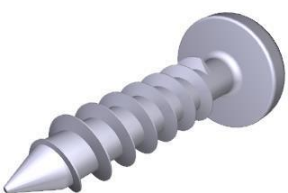

COMPONENT			SPARE PART		
Code	Description	Image	Code	Description	Kit components
0B1174A	XEBC-04EU-E LEFT EXT DOOR COLUMN		0B1174A0	XEBC-04EU-E LEFT EXT DOOR COLUMN	
0B1218B	860MM DOUBLE GLASS DOOR UPPER BEAM		0B1218B0	860MM DOUBLE GLASS DOOR UPPER BEAM	
0B1219A	MM DOUBLE GLASS DOOR INT UPPER BEAM 860		OUTOFPRODUCTIO	ITEM OUT OF PRODUCTION	
VI1930A	5x20 ST. STEEL CHIP SCREW		VI1147A0	5X25 STAINLESS STEEL SCREW	
VI1996A	M5x35 SCREW		VI1996A0	M5x35 SCREW	



COMPONENT			SPARE PART																																														
Code	Description	Image	Code	Description	Kit components																																												
VM2262B	MM -M DOOR RIGHT UPPER CAP		KVM2262B	MIND.MAPS -M DOOR RIGHT UPPER CAP KIT	<table border="1"> <thead> <tr> <th>Code</th> <th>Description</th> <th>Qty</th> <th>UOM</th> </tr> </thead> <tbody> <tr> <td>RC1200A0</td> <td>ED=4 WIRE D=0.5 H24 COMPRESSIO N SPRING</td> <td>2.000</td> <td>PC</td> </tr> <tr> <td>VE1030A1</td> <td>MAGNET FOR DOOR MICROSWITC H D=22.9mm</td> <td>1.000</td> <td>PC</td> </tr> <tr> <td>VI1220A1</td> <td>4,2x12 TCB SELF-TAPPIN G SCREW</td> <td>1.000</td> <td>PC</td> </tr> <tr> <td>VI1930A1</td> <td>5x20 ST. STEEL CHIP SCREW</td> <td>4.000</td> <td>PC</td> </tr> <tr> <td>VI1996A0</td> <td>M5x35 SCREW</td> <td>4.000</td> <td>PC</td> </tr> <tr> <td>VM2262B0</td> <td>MM -M DOOR RIGHT UPPER CAP</td> <td>1.000</td> <td>PC</td> </tr> <tr> <td>VM2267A0</td> <td>INTERNAL GLASS LOCKING SYSTEM SLIDER</td> <td>1.000</td> <td>PC</td> </tr> <tr> <td>VM2268A0</td> <td>DOOR MAGNET COVER</td> <td>1.000</td> <td>PC</td> </tr> <tr> <td>VM2269B0</td> <td>INNER GLASS FIXING CAP</td> <td>1.000</td> <td>PC</td> </tr> <tr> <td>VM2305A0</td> <td>MM SERIES DOOR CAP FIXING PAWL</td> <td>4.000</td> <td>PC</td> </tr> </tbody> </table>	Code	Description	Qty	UOM	RC1200A0	ED=4 WIRE D=0.5 H24 COMPRESSIO N SPRING	2.000	PC	VE1030A1	MAGNET FOR DOOR MICROSWITC H D=22.9mm	1.000	PC	VI1220A1	4,2x12 TCB SELF-TAPPIN G SCREW	1.000	PC	VI1930A1	5x20 ST. STEEL CHIP SCREW	4.000	PC	VI1996A0	M5x35 SCREW	4.000	PC	VM2262B0	MM -M DOOR RIGHT UPPER CAP	1.000	PC	VM2267A0	INTERNAL GLASS LOCKING SYSTEM SLIDER	1.000	PC	VM2268A0	DOOR MAGNET COVER	1.000	PC	VM2269B0	INNER GLASS FIXING CAP	1.000	PC	VM2305A0	MM SERIES DOOR CAP FIXING PAWL	4.000	PC
Code	Description	Qty	UOM																																														
RC1200A0	ED=4 WIRE D=0.5 H24 COMPRESSIO N SPRING	2.000	PC																																														
VE1030A1	MAGNET FOR DOOR MICROSWITC H D=22.9mm	1.000	PC																																														
VI1220A1	4,2x12 TCB SELF-TAPPIN G SCREW	1.000	PC																																														
VI1930A1	5x20 ST. STEEL CHIP SCREW	4.000	PC																																														
VI1996A0	M5x35 SCREW	4.000	PC																																														
VM2262B0	MM -M DOOR RIGHT UPPER CAP	1.000	PC																																														
VM2267A0	INTERNAL GLASS LOCKING SYSTEM SLIDER	1.000	PC																																														
VM2268A0	DOOR MAGNET COVER	1.000	PC																																														
VM2269B0	INNER GLASS FIXING CAP	1.000	PC																																														
VM2305A0	MM SERIES DOOR CAP FIXING PAWL	4.000	PC																																														
VM2267A	INTERNAL GLASS LOCKING SYSTEM SLIDER		KVM2386B	MM -M LEFT DOOR LEFT LOWER CAP KI	<table border="1"> <thead> <tr> <th>Code</th> <th>Description</th> <th>Qty</th> <th>UOM</th> </tr> </thead> <tbody> <tr> <td>RC1200A0</td> <td>ED=4 WIRE D=0.5 H24 COMPRESSIO N SPRING</td> <td>2.000</td> <td>PC</td> </tr> <tr> <td>VE1030A1</td> <td>MAGNET FOR DOOR MICROSWITC H D=22.9mm</td> <td>1.000</td> <td>PC</td> </tr> <tr> <td>VI1220A1</td> <td>4,2x12 TCB SELF-TAPPIN G SCREW</td> <td>1.000</td> <td>PC</td> </tr> <tr> <td>VI1930A1</td> <td>5x20 ST. STEEL CHIP SCREW</td> <td>4.000</td> <td>PC</td> </tr> <tr> <td>VI1996A0</td> <td>M5x35 SCREW</td> <td>4.000</td> <td>PC</td> </tr> <tr> <td>VM2267A0</td> <td>INTERNAL GLASS LOCKING SYSTEM SLIDER</td> <td>1.000</td> <td>PC</td> </tr> </tbody> </table>	Code	Description	Qty	UOM	RC1200A0	ED=4 WIRE D=0.5 H24 COMPRESSIO N SPRING	2.000	PC	VE1030A1	MAGNET FOR DOOR MICROSWITC H D=22.9mm	1.000	PC	VI1220A1	4,2x12 TCB SELF-TAPPIN G SCREW	1.000	PC	VI1930A1	5x20 ST. STEEL CHIP SCREW	4.000	PC	VI1996A0	M5x35 SCREW	4.000	PC	VM2267A0	INTERNAL GLASS LOCKING SYSTEM SLIDER	1.000	PC																
Code	Description	Qty	UOM																																														
RC1200A0	ED=4 WIRE D=0.5 H24 COMPRESSIO N SPRING	2.000	PC																																														
VE1030A1	MAGNET FOR DOOR MICROSWITC H D=22.9mm	1.000	PC																																														
VI1220A1	4,2x12 TCB SELF-TAPPIN G SCREW	1.000	PC																																														
VI1930A1	5x20 ST. STEEL CHIP SCREW	4.000	PC																																														
VI1996A0	M5x35 SCREW	4.000	PC																																														
VM2267A0	INTERNAL GLASS LOCKING SYSTEM SLIDER	1.000	PC																																														





COMPONENT			SPARE PART																																											
Code	Description	Image	Code	Description	Kit components																																									
VM2267A	INTERNAL GLASS LOCKING SYSTEM SLIDER		KVM2386B	MM -M LEFT DOOR LEFT LOWER CAP KI	<table border="1"> <thead> <tr> <th>Code</th> <th>Description</th> <th>Qty</th> <th>UOM</th> </tr> </thead> <tbody> <tr> <td>VM2268A0</td> <td>DOOR MAGNET COVER</td> <td>1.000</td> <td>PC</td> </tr> <tr> <td>VM2269B0</td> <td>INNER GLASS FIXING CAP</td> <td>1.000</td> <td>PC</td> </tr> <tr> <td>VM2305A0</td> <td>MM SERIES DOOR CAP FIXING PAWL</td> <td>4.000</td> <td>PC</td> </tr> <tr> <td>VM2386B0</td> <td>MM -M LEFT DOOR LEFT LOWER CAP KI</td> <td>1.000</td> <td>PC</td> </tr> </tbody> </table>	Code	Description	Qty	UOM	VM2268A0	DOOR MAGNET COVER	1.000	PC	VM2269B0	INNER GLASS FIXING CAP	1.000	PC	VM2305A0	MM SERIES DOOR CAP FIXING PAWL	4.000	PC	VM2386B0	MM -M LEFT DOOR LEFT LOWER CAP KI	1.000	PC																					
			Code	Description	Qty	UOM																																								
			VM2268A0	DOOR MAGNET COVER	1.000	PC																																								
VM2269B0	INNER GLASS FIXING CAP	1.000	PC																																											
VM2305A0	MM SERIES DOOR CAP FIXING PAWL	4.000	PC																																											
VM2386B0	MM -M LEFT DOOR LEFT LOWER CAP KI	1.000	PC																																											
KVM2385B	MM -M LEFT DOOR LEFT UPPER CAP KI	<table border="1"> <thead> <tr> <th>Code</th> <th>Description</th> <th>Qty</th> <th>UOM</th> </tr> </thead> <tbody> <tr> <td>RC1200A0</td> <td>ED=4 WIRE D=0.5 H24 COMPRESSIO N SPRING</td> <td>2.000</td> <td>PC</td> </tr> <tr> <td>VE1030A1</td> <td>MAGNET FOR DOOR MICROSWITC H D=22,9mm</td> <td>1.000</td> <td>PC</td> </tr> <tr> <td>VH1220A1</td> <td>4,2x12 TCB SELF-TAPPIN G SCREW</td> <td>1.000</td> <td>PC</td> </tr> <tr> <td>VI1930A1</td> <td>5x20 ST. STEEL CHIP SCREW</td> <td>4.000</td> <td>PC</td> </tr> <tr> <td>VI1996A0</td> <td>M5x35 SCREW</td> <td>4.000</td> <td>PC</td> </tr> <tr> <td>VM2267A0</td> <td>INTERNAL GLASS LOCKING SYSTEM SLIDER</td> <td>1.000</td> <td>PC</td> </tr> <tr> <td>VM2268A0</td> <td>DOOR MAGNET COVER</td> <td>1.000</td> <td>PC</td> </tr> <tr> <td>VM2269B0</td> <td>INNER GLASS FIXING CAP</td> <td>1.000</td> <td>PC</td> </tr> <tr> <td>VM2305A0</td> <td>MM SERIES DOOR CAP FIXING PAWL</td> <td>4.000</td> <td>PC</td> </tr> <tr> <td>VM2385B0</td> <td>MM LEFT DOOR UPPER LEFT CAP</td> <td>1.000</td> <td>PC</td> </tr> </tbody> </table>	Code	Description	Qty	UOM	RC1200A0	ED=4 WIRE D=0.5 H24 COMPRESSIO N SPRING	2.000	PC	VE1030A1	MAGNET FOR DOOR MICROSWITC H D=22,9mm	1.000	PC	VH1220A1	4,2x12 TCB SELF-TAPPIN G SCREW	1.000	PC	VI1930A1	5x20 ST. STEEL CHIP SCREW	4.000	PC	VI1996A0	M5x35 SCREW	4.000	PC	VM2267A0	INTERNAL GLASS LOCKING SYSTEM SLIDER	1.000	PC	VM2268A0	DOOR MAGNET COVER	1.000	PC	VM2269B0	INNER GLASS FIXING CAP	1.000	PC	VM2305A0	MM SERIES DOOR CAP FIXING PAWL	4.000	PC	VM2385B0	MM LEFT DOOR UPPER LEFT CAP	1.000	PC
Code	Description	Qty	UOM																																											
RC1200A0	ED=4 WIRE D=0.5 H24 COMPRESSIO N SPRING	2.000	PC																																											
VE1030A1	MAGNET FOR DOOR MICROSWITC H D=22,9mm	1.000	PC																																											
VH1220A1	4,2x12 TCB SELF-TAPPIN G SCREW	1.000	PC																																											
VI1930A1	5x20 ST. STEEL CHIP SCREW	4.000	PC																																											
VI1996A0	M5x35 SCREW	4.000	PC																																											
VM2267A0	INTERNAL GLASS LOCKING SYSTEM SLIDER	1.000	PC																																											
VM2268A0	DOOR MAGNET COVER	1.000	PC																																											
VM2269B0	INNER GLASS FIXING CAP	1.000	PC																																											
VM2305A0	MM SERIES DOOR CAP FIXING PAWL	4.000	PC																																											
VM2385B0	MM LEFT DOOR UPPER LEFT CAP	1.000	PC																																											
KVM2262B	MIND.MAPS -M DOOR RIGHT UPPER CAP KIT	<table border="1"> <thead> <tr> <th>Code</th> <th>Description</th> <th>Qty</th> <th>UOM</th> </tr> </thead> <tbody> <tr> <td>RC1200A0</td> <td>ED=4 WIRE D=0.5 H24 COMPRESSIO N SPRING</td> <td>2.000</td> <td>PC</td> </tr> <tr> <td>VE1030A1</td> <td>MAGNET FOR DOOR MICROSWITC H D=22,9mm</td> <td>1.000</td> <td>PC</td> </tr> </tbody> </table>	Code	Description	Qty	UOM	RC1200A0	ED=4 WIRE D=0.5 H24 COMPRESSIO N SPRING	2.000	PC	VE1030A1	MAGNET FOR DOOR MICROSWITC H D=22,9mm	1.000	PC																																
Code	Description	Qty	UOM																																											
RC1200A0	ED=4 WIRE D=0.5 H24 COMPRESSIO N SPRING	2.000	PC																																											
VE1030A1	MAGNET FOR DOOR MICROSWITC H D=22,9mm	1.000	PC																																											



COMPONENT			SPARE PART																																											
Code	Description	Image	Code	Description	Kit components																																									
VM2267A	INTERNAL GLASS LOCKING SYSTEM SLIDER		KVM2262B	MIND.MAPS -M DOOR RIGHT UPPER CAP KIT	<table border="1"> <thead> <tr> <th>Code</th> <th>Description</th> <th>Qty</th> <th>UOM</th> </tr> </thead> <tbody> <tr> <td>VI1220A1</td> <td>4,2x12 TCB SELF-TAPPIN G SCREW</td> <td>1.000</td> <td>PC</td> </tr> <tr> <td>VI1930A1</td> <td>5x20 ST. STEEL CHIP SCREW</td> <td>4.000</td> <td>PC</td> </tr> <tr> <td>VI1996A0</td> <td>M5x35 SCREW</td> <td>4.000</td> <td>PC</td> </tr> <tr> <td>VM2262B0</td> <td>MM -M DOOR RIGHT UPPER CAP</td> <td>1.000</td> <td>PC</td> </tr> <tr> <td>VM2267A0</td> <td>INTERNAL GLASS LOCKING SYSTEM SLIDER</td> <td>1.000</td> <td>PC</td> </tr> <tr> <td>VM2268A0</td> <td>DOOR MAGNET COVER</td> <td>1.000</td> <td>PC</td> </tr> <tr> <td>VM2269B0</td> <td>INNER GLASS FIXING CAP</td> <td>1.000</td> <td>PC</td> </tr> <tr> <td>VM2305A0</td> <td>MM SERIES DOOR CAP FIXING PAWL</td> <td>4.000</td> <td>PC</td> </tr> </tbody> </table>	Code	Description	Qty	UOM	VI1220A1	4,2x12 TCB SELF-TAPPIN G SCREW	1.000	PC	VI1930A1	5x20 ST. STEEL CHIP SCREW	4.000	PC	VI1996A0	M5x35 SCREW	4.000	PC	VM2262B0	MM -M DOOR RIGHT UPPER CAP	1.000	PC	VM2267A0	INTERNAL GLASS LOCKING SYSTEM SLIDER	1.000	PC	VM2268A0	DOOR MAGNET COVER	1.000	PC	VM2269B0	INNER GLASS FIXING CAP	1.000	PC	VM2305A0	MM SERIES DOOR CAP FIXING PAWL	4.000	PC					
			Code	Description	Qty	UOM																																								
VI1220A1	4,2x12 TCB SELF-TAPPIN G SCREW	1.000	PC																																											
VI1930A1	5x20 ST. STEEL CHIP SCREW	4.000	PC																																											
VI1996A0	M5x35 SCREW	4.000	PC																																											
VM2262B0	MM -M DOOR RIGHT UPPER CAP	1.000	PC																																											
VM2267A0	INTERNAL GLASS LOCKING SYSTEM SLIDER	1.000	PC																																											
VM2268A0	DOOR MAGNET COVER	1.000	PC																																											
VM2269B0	INNER GLASS FIXING CAP	1.000	PC																																											
VM2305A0	MM SERIES DOOR CAP FIXING PAWL	4.000	PC																																											
KVM2261B	MIND.MAPS -M DOOR RIGHT LOWER CAP KIT	<table border="1"> <thead> <tr> <th>Code</th> <th>Description</th> <th>Qty</th> <th>UOM</th> </tr> </thead> <tbody> <tr> <td>RC1200A0</td> <td>ED=4 WIRE D=0.5 H24 COMPRESSIO N SPRING</td> <td>2.000</td> <td>PC</td> </tr> <tr> <td>VE1030A1</td> <td>MAGNET FOR DOOR MICROSWITC H D=22,9mm</td> <td>1.000</td> <td>PC</td> </tr> <tr> <td>VI1220A1</td> <td>4,2x12 TCB SELF-TAPPIN G SCREW</td> <td>1.000</td> <td>PC</td> </tr> <tr> <td>VI1930A1</td> <td>5x20 ST. STEEL CHIP SCREW</td> <td>4.000</td> <td>PC</td> </tr> <tr> <td>VI1996A0</td> <td>M5x35 SCREW</td> <td>4.000</td> <td>PC</td> </tr> <tr> <td>VM2261B0</td> <td>MM -M DOOR RIGHT LOWER CAP</td> <td>1.000</td> <td>PC</td> </tr> <tr> <td>VM2267A0</td> <td>INTERNAL GLASS LOCKING SYSTEM SLIDER</td> <td>1.000</td> <td>PC</td> </tr> <tr> <td>VM2268A0</td> <td>DOOR MAGNET COVER</td> <td>1.000</td> <td>PC</td> </tr> <tr> <td>VM2269B0</td> <td>INNER GLASS FIXING CAP</td> <td>1.000</td> <td>PC</td> </tr> <tr> <td>VM2305A0</td> <td>MM SERIES DOOR CAP FIXING PAWL</td> <td>4.000</td> <td>PC</td> </tr> </tbody> </table>	Code	Description	Qty	UOM	RC1200A0	ED=4 WIRE D=0.5 H24 COMPRESSIO N SPRING	2.000	PC	VE1030A1	MAGNET FOR DOOR MICROSWITC H D=22,9mm	1.000	PC	VI1220A1	4,2x12 TCB SELF-TAPPIN G SCREW	1.000	PC	VI1930A1	5x20 ST. STEEL CHIP SCREW	4.000	PC	VI1996A0	M5x35 SCREW	4.000	PC	VM2261B0	MM -M DOOR RIGHT LOWER CAP	1.000	PC	VM2267A0	INTERNAL GLASS LOCKING SYSTEM SLIDER	1.000	PC	VM2268A0	DOOR MAGNET COVER	1.000	PC	VM2269B0	INNER GLASS FIXING CAP	1.000	PC	VM2305A0	MM SERIES DOOR CAP FIXING PAWL	4.000	PC
Code	Description	Qty	UOM																																											
RC1200A0	ED=4 WIRE D=0.5 H24 COMPRESSIO N SPRING	2.000	PC																																											
VE1030A1	MAGNET FOR DOOR MICROSWITC H D=22,9mm	1.000	PC																																											
VI1220A1	4,2x12 TCB SELF-TAPPIN G SCREW	1.000	PC																																											
VI1930A1	5x20 ST. STEEL CHIP SCREW	4.000	PC																																											
VI1996A0	M5x35 SCREW	4.000	PC																																											
VM2261B0	MM -M DOOR RIGHT LOWER CAP	1.000	PC																																											
VM2267A0	INTERNAL GLASS LOCKING SYSTEM SLIDER	1.000	PC																																											
VM2268A0	DOOR MAGNET COVER	1.000	PC																																											
VM2269B0	INNER GLASS FIXING CAP	1.000	PC																																											
VM2305A0	MM SERIES DOOR CAP FIXING PAWL	4.000	PC																																											

COMPONENT			SPARE PART																																						
Code	Description	Image	Code	Description	Kit components																																				
VM2269B	INNER GLASS FIXING CAP		KVM2269B	INNER GLASS FIXING CAP KIT -M	<table border="1"> <thead> <tr> <th>Code</th> <th>Description</th> <th>Qty</th> <th>UOM</th> </tr> </thead> <tbody> <tr> <td>VM2269B0</td> <td>INNER GLASS FIXING CAP</td> <td>2.000</td> <td>PC</td> </tr> </tbody> </table>	Code	Description	Qty	UOM	VM2269B0	INNER GLASS FIXING CAP	2.000	PC																												
Code	Description	Qty	UOM																																						
VM2269B0	INNER GLASS FIXING CAP	2.000	PC																																						
VM2305A	MM SERIES DOOR CAP FIXING PAWL		KVM2305A	MM FIXING DOOR THUB SCREWS 10 PCS KIT	<table border="1"> <thead> <tr> <th>Code</th> <th>Description</th> <th>Qty</th> <th>UOM</th> </tr> </thead> <tbody> <tr> <td>VM2305A0</td> <td>MM SERIES DOOR CAP FIXING PAWL</td> <td>10.000</td> <td>PC</td> </tr> </tbody> </table>	Code	Description	Qty	UOM	VM2305A0	MM SERIES DOOR CAP FIXING PAWL	10.000	PC																												
Code	Description	Qty	UOM																																						
VM2305A0	MM SERIES DOOR CAP FIXING PAWL	10.000	PC																																						
VE1030A	MAGNET FOR DOOR MICROSWITCH D=22,9mm		KVE1030A	2 PCS MAGNET KIT FOR DOOR SWITCH	<table border="1"> <thead> <tr> <th>Code</th> <th>Description</th> <th>Qty</th> <th>UOM</th> </tr> </thead> <tbody> <tr> <td>VE1030A1</td> <td>MAGNET FOR DOOR MICROSWITC H D=22,9mm</td> <td>2.000</td> <td>PC</td> </tr> <tr> <td>VI1220A1</td> <td>4,2x12 TCB SELF-TAPPIN G SCREW</td> <td>1.000</td> <td>PC</td> </tr> </tbody> </table>	Code	Description	Qty	UOM	VE1030A1	MAGNET FOR DOOR MICROSWITC H D=22,9mm	2.000	PC	VI1220A1	4,2x12 TCB SELF-TAPPIN G SCREW	1.000	PC																								
Code	Description	Qty	UOM																																						
VE1030A1	MAGNET FOR DOOR MICROSWITC H D=22,9mm	2.000	PC																																						
VI1220A1	4,2x12 TCB SELF-TAPPIN G SCREW	1.000	PC																																						
			KVE1020B	MICROSWITCH KIT	<table border="1"> <thead> <tr> <th>Code</th> <th>Description</th> <th>Qty</th> <th>UOM</th> </tr> </thead> <tbody> <tr> <td>CE1030A0</td> <td>FEMALE FASTON COVER 6.3X0.8 0,5-1mmg</td> <td>2.000</td> <td>PC</td> </tr> <tr> <td>CE1660A0</td> <td>6,3x0,8 FEMALE FASTON COVE</td> <td>2.000</td> <td>PC</td> </tr> <tr> <td>CE1730A0</td> <td>PVC CABLE NP 2 X AWG22 STYLE 2095</td> <td>0.150</td> <td>M</td> </tr> <tr> <td>CE1740A0</td> <td>MINIFIT MALE END FITTING</td> <td>2.000</td> <td>PC</td> </tr> <tr> <td>CE1745A0</td> <td>2 WAYS FEMALE MINIFIT CONNECTOR</td> <td>1.000</td> <td>PC</td> </tr> <tr> <td>VE1020B0</td> <td>MAGNET DOOR MICROSWITC</td> <td>1.000</td> <td>PC</td> </tr> <tr> <td>VE1030A1</td> <td>MAGNET FOR DOOR MICROSWITC H D=22,9mm</td> <td>1.000</td> <td>PC</td> </tr> <tr> <td>VI1192A0</td> <td></td> <td>1.000</td> <td>PC</td> </tr> </tbody> </table>	Code	Description	Qty	UOM	CE1030A0	FEMALE FASTON COVER 6.3X0.8 0,5-1mmg	2.000	PC	CE1660A0	6,3x0,8 FEMALE FASTON COVE	2.000	PC	CE1730A0	PVC CABLE NP 2 X AWG22 STYLE 2095	0.150	M	CE1740A0	MINIFIT MALE END FITTING	2.000	PC	CE1745A0	2 WAYS FEMALE MINIFIT CONNECTOR	1.000	PC	VE1020B0	MAGNET DOOR MICROSWITC	1.000	PC	VE1030A1	MAGNET FOR DOOR MICROSWITC H D=22,9mm	1.000	PC	VI1192A0		1.000	PC
Code	Description	Qty	UOM																																						
CE1030A0	FEMALE FASTON COVER 6.3X0.8 0,5-1mmg	2.000	PC																																						
CE1660A0	6,3x0,8 FEMALE FASTON COVE	2.000	PC																																						
CE1730A0	PVC CABLE NP 2 X AWG22 STYLE 2095	0.150	M																																						
CE1740A0	MINIFIT MALE END FITTING	2.000	PC																																						
CE1745A0	2 WAYS FEMALE MINIFIT CONNECTOR	1.000	PC																																						
VE1020B0	MAGNET DOOR MICROSWITC	1.000	PC																																						
VE1030A1	MAGNET FOR DOOR MICROSWITC H D=22,9mm	1.000	PC																																						
VI1192A0		1.000	PC																																						

COMPONENT			SPARE PART																																														
Code	Description	Image	Code	Description	Kit components																																												
VI1930A	5x20 ST. STEEL CHIP SCREW		VI1147A0	5X25 STAINLESS STEEL SCREW																																													
VI1996A	M5x35 SCREW		VI1996A0	M5x35 SCREW																																													
VM2261B	MM -M DOOR RIGHT LOWER CAP		KVM2261B	MIND.MAPS -M DOOR RIGHT LOWER CAP KIT	<table border="1"> <thead> <tr> <th>Code</th> <th>Description</th> <th>Qty</th> <th>UOM</th> </tr> </thead> <tbody> <tr> <td>RC1200A0</td> <td>ED=4 WIRE D=0.5 H24 COMPRESSIO N SPRING</td> <td>2.000</td> <td>PC</td> </tr> <tr> <td>VE1030A1</td> <td>MAGNET FOR DOOR MICROSWITC H D=22.9mm</td> <td>1.000</td> <td>PC</td> </tr> <tr> <td>VI1220A1</td> <td>4,2x12 TCB SELF-TAPPIN G SCREW</td> <td>1.000</td> <td>PC</td> </tr> <tr> <td>VI1930A1</td> <td>5x20 ST. STEEL CHIP SCREW</td> <td>4.000</td> <td>PC</td> </tr> <tr> <td>VI1996A0</td> <td>M5x35 SCREW</td> <td>4.000</td> <td>PC</td> </tr> <tr> <td>VM2261B0</td> <td>MM -M DOOR RIGHT LOWER CAP</td> <td>1.000</td> <td>PC</td> </tr> <tr> <td>VM2267A0</td> <td>INTERNAL GLASS LOCKING SYSTEM SLIDER</td> <td>1.000</td> <td>PC</td> </tr> <tr> <td>VM2268A0</td> <td>DOOR MAGNET COVER</td> <td>1.000</td> <td>PC</td> </tr> <tr> <td>VM2269B0</td> <td>INNER GLASS FIXING CAP</td> <td>1.000</td> <td>PC</td> </tr> <tr> <td>VM2305A0</td> <td>MM SERIES DOOR CAP FIXING PAWL</td> <td>4.000</td> <td>PC</td> </tr> </tbody> </table>	Code	Description	Qty	UOM	RC1200A0	ED=4 WIRE D=0.5 H24 COMPRESSIO N SPRING	2.000	PC	VE1030A1	MAGNET FOR DOOR MICROSWITC H D=22.9mm	1.000	PC	VI1220A1	4,2x12 TCB SELF-TAPPIN G SCREW	1.000	PC	VI1930A1	5x20 ST. STEEL CHIP SCREW	4.000	PC	VI1996A0	M5x35 SCREW	4.000	PC	VM2261B0	MM -M DOOR RIGHT LOWER CAP	1.000	PC	VM2267A0	INTERNAL GLASS LOCKING SYSTEM SLIDER	1.000	PC	VM2268A0	DOOR MAGNET COVER	1.000	PC	VM2269B0	INNER GLASS FIXING CAP	1.000	PC	VM2305A0	MM SERIES DOOR CAP FIXING PAWL	4.000	PC
Code	Description	Qty	UOM																																														
RC1200A0	ED=4 WIRE D=0.5 H24 COMPRESSIO N SPRING	2.000	PC																																														
VE1030A1	MAGNET FOR DOOR MICROSWITC H D=22.9mm	1.000	PC																																														
VI1220A1	4,2x12 TCB SELF-TAPPIN G SCREW	1.000	PC																																														
VI1930A1	5x20 ST. STEEL CHIP SCREW	4.000	PC																																														
VI1996A0	M5x35 SCREW	4.000	PC																																														
VM2261B0	MM -M DOOR RIGHT LOWER CAP	1.000	PC																																														
VM2267A0	INTERNAL GLASS LOCKING SYSTEM SLIDER	1.000	PC																																														
VM2268A0	DOOR MAGNET COVER	1.000	PC																																														
VM2269B0	INNER GLASS FIXING CAP	1.000	PC																																														
VM2305A0	MM SERIES DOOR CAP FIXING PAWL	4.000	PC																																														







COMPONENT			SPARE PART																																																																													
Code	Description	Image	Code	Description	Kit components																																																																											
VM2267A	INTERNAL GLASS LOCKING SYSTEM SLIDER		KVM2386B	MM -M LEFT DOOR LEFT LOWER CAP KI	<table border="1"> <thead> <tr> <th>Code</th> <th>Description</th> <th>Qty</th> <th>UOM</th> </tr> </thead> <tbody> <tr> <td>RC1200A0</td> <td>ED=4 WIRE D=0.5 H24 COMPRESSIO N SPRING</td> <td>2.000</td> <td>PC</td> </tr> <tr> <td>VE1030A1</td> <td>MAGNET FOR DOOR MICROSWITC H D=22.9mm</td> <td>1.000</td> <td>PC</td> </tr> <tr> <td>VI1220A1</td> <td>4,2x12 TCB SELF-TAPPIN G SCREW</td> <td>1.000</td> <td>PC</td> </tr> <tr> <td>VI1930A1</td> <td>5x20 ST. STEEL CHIP SCREW</td> <td>4.000</td> <td>PC</td> </tr> <tr> <td>VI1996A0</td> <td>M5x35 SCREW</td> <td>4.000</td> <td>PC</td> </tr> <tr> <td>VM2267A0</td> <td>INTERNAL GLASS LOCKING SYSTEM SLIDER</td> <td>1.000</td> <td>PC</td> </tr> <tr> <td>VM2268A0</td> <td>DOOR MAGNET COVER</td> <td>1.000</td> <td>PC</td> </tr> <tr> <td>VM2269B0</td> <td>INNER GLASS FIXING CAP</td> <td>1.000</td> <td>PC</td> </tr> <tr> <td>VM2305A0</td> <td>MM SERIES DOOR CAP FIXING PAWL</td> <td>4.000</td> <td>PC</td> </tr> <tr> <td>VM2386B0</td> <td>MM -M LEFT DOOR LEFT LOWER CAP KI</td> <td>1.000</td> <td>PC</td> </tr> </tbody> </table>	Code	Description	Qty	UOM	RC1200A0	ED=4 WIRE D=0.5 H24 COMPRESSIO N SPRING	2.000	PC	VE1030A1	MAGNET FOR DOOR MICROSWITC H D=22.9mm	1.000	PC	VI1220A1	4,2x12 TCB SELF-TAPPIN G SCREW	1.000	PC	VI1930A1	5x20 ST. STEEL CHIP SCREW	4.000	PC	VI1996A0	M5x35 SCREW	4.000	PC	VM2267A0	INTERNAL GLASS LOCKING SYSTEM SLIDER	1.000	PC	VM2268A0	DOOR MAGNET COVER	1.000	PC	VM2269B0	INNER GLASS FIXING CAP	1.000	PC	VM2305A0	MM SERIES DOOR CAP FIXING PAWL	4.000	PC	VM2386B0	MM -M LEFT DOOR LEFT LOWER CAP KI	1.000	PC	KVM2385B	MM -M LEFT DOOR LEFT UPPER CAP KI	<table border="1"> <thead> <tr> <th>Code</th> <th>Description</th> <th>Qty</th> <th>UOM</th> </tr> </thead> <tbody> <tr> <td>RC1200A0</td> <td>ED=4 WIRE D=0.5 H24 COMPRESSIO N SPRING</td> <td>2.000</td> <td>PC</td> </tr> <tr> <td>VE1030A1</td> <td>MAGNET FOR DOOR MICROSWITC H D=22.9mm</td> <td>1.000</td> <td>PC</td> </tr> <tr> <td>VI1220A1</td> <td>4,2x12 TCB SELF-TAPPIN G SCREW</td> <td>1.000</td> <td>PC</td> </tr> <tr> <td>VI1930A1</td> <td>5x20 ST. STEEL CHIP SCREW</td> <td>4.000</td> <td>PC</td> </tr> <tr> <td>VI1996A0</td> <td>M5x35 SCREW</td> <td>4.000</td> <td>PC</td> </tr> <tr> <td>VM2267A0</td> <td>INTERNAL GLASS LOCKING SYSTEM SLIDER</td> <td>1.000</td> <td>PC</td> </tr> </tbody> </table>	Code	Description	Qty	UOM	RC1200A0	ED=4 WIRE D=0.5 H24 COMPRESSIO N SPRING	2.000	PC	VE1030A1	MAGNET FOR DOOR MICROSWITC H D=22.9mm	1.000	PC	VI1220A1	4,2x12 TCB SELF-TAPPIN G SCREW	1.000	PC	VI1930A1	5x20 ST. STEEL CHIP SCREW	4.000	PC	VI1996A0	M5x35 SCREW	4.000	PC	VM2267A0	INTERNAL GLASS LOCKING SYSTEM SLIDER	1.000	PC
			Code	Description	Qty	UOM																																																																										
RC1200A0	ED=4 WIRE D=0.5 H24 COMPRESSIO N SPRING	2.000	PC																																																																													
VE1030A1	MAGNET FOR DOOR MICROSWITC H D=22.9mm	1.000	PC																																																																													
VI1220A1	4,2x12 TCB SELF-TAPPIN G SCREW	1.000	PC																																																																													
VI1930A1	5x20 ST. STEEL CHIP SCREW	4.000	PC																																																																													
VI1996A0	M5x35 SCREW	4.000	PC																																																																													
VM2267A0	INTERNAL GLASS LOCKING SYSTEM SLIDER	1.000	PC																																																																													
VM2268A0	DOOR MAGNET COVER	1.000	PC																																																																													
VM2269B0	INNER GLASS FIXING CAP	1.000	PC																																																																													
VM2305A0	MM SERIES DOOR CAP FIXING PAWL	4.000	PC																																																																													
VM2386B0	MM -M LEFT DOOR LEFT LOWER CAP KI	1.000	PC																																																																													
Code	Description	Qty	UOM																																																																													
RC1200A0	ED=4 WIRE D=0.5 H24 COMPRESSIO N SPRING	2.000	PC																																																																													
VE1030A1	MAGNET FOR DOOR MICROSWITC H D=22.9mm	1.000	PC																																																																													
VI1220A1	4,2x12 TCB SELF-TAPPIN G SCREW	1.000	PC																																																																													
VI1930A1	5x20 ST. STEEL CHIP SCREW	4.000	PC																																																																													
VI1996A0	M5x35 SCREW	4.000	PC																																																																													
VM2267A0	INTERNAL GLASS LOCKING SYSTEM SLIDER	1.000	PC																																																																													

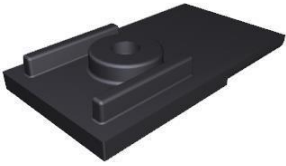

COMPONENT			SPARE PART																																											
Code	Description	Image	Code	Description	Kit components																																									
VM2267A	INTERNAL GLASS LOCKING SYSTEM SLIDER		KVM2385B	MM -M LEFT DOOR LEFT UPPER CAP KI	<table border="1"> <thead> <tr> <th>Code</th> <th>Description</th> <th>Qty</th> <th>UOM</th> </tr> </thead> <tbody> <tr> <td>VM2268A0</td> <td>DOOR MAGNET COVER</td> <td>1.000</td> <td>PC</td> </tr> <tr> <td>VM2269B0</td> <td>INNER GLASS FIXING CAP</td> <td>1.000</td> <td>PC</td> </tr> <tr> <td>VM2305A0</td> <td>MM SERIES DOOR CAP FIXING PAWL</td> <td>4.000</td> <td>PC</td> </tr> <tr> <td>VM2385B0</td> <td>MM LEFT DOOR UPPER LEFT CAP</td> <td>1.000</td> <td>PC</td> </tr> </tbody> </table>	Code	Description	Qty	UOM	VM2268A0	DOOR MAGNET COVER	1.000	PC	VM2269B0	INNER GLASS FIXING CAP	1.000	PC	VM2305A0	MM SERIES DOOR CAP FIXING PAWL	4.000	PC	VM2385B0	MM LEFT DOOR UPPER LEFT CAP	1.000	PC																					
			Code	Description	Qty	UOM																																								
			VM2268A0	DOOR MAGNET COVER	1.000	PC																																								
VM2269B0	INNER GLASS FIXING CAP	1.000	PC																																											
VM2305A0	MM SERIES DOOR CAP FIXING PAWL	4.000	PC																																											
VM2385B0	MM LEFT DOOR UPPER LEFT CAP	1.000	PC																																											
KVM2262B	MIND.MAPS -M DOOR RIGHT UPPER CAP KIT	<table border="1"> <thead> <tr> <th>Code</th> <th>Description</th> <th>Qty</th> <th>UOM</th> </tr> </thead> <tbody> <tr> <td>RC1200A0</td> <td>ED=4 WIRE D=0.5 H24 COMPRESSIO N SPRING</td> <td>2.000</td> <td>PC</td> </tr> <tr> <td>VE1030A1</td> <td>MAGNET FOR DOOR MICROSWITC H D=22,9mm</td> <td>1.000</td> <td>PC</td> </tr> <tr> <td>VI1220A1</td> <td>4,2x12 TCB SELF-TAPPIN G SCREW</td> <td>1.000</td> <td>PC</td> </tr> <tr> <td>VI1930A1</td> <td>5x20 ST. STEEL CHIP SCREW</td> <td>4.000</td> <td>PC</td> </tr> <tr> <td>VI1996A0</td> <td>M5x35 SCREW</td> <td>4.000</td> <td>PC</td> </tr> <tr> <td>VM2262B0</td> <td>MM -M DOOR RIGHT UPPER CAP</td> <td>1.000</td> <td>PC</td> </tr> <tr> <td>VM2267A0</td> <td>INTERNAL GLASS LOCKING SYSTEM SLIDER</td> <td>1.000</td> <td>PC</td> </tr> <tr> <td>VM2268A0</td> <td>DOOR MAGNET COVER</td> <td>1.000</td> <td>PC</td> </tr> <tr> <td>VM2269B0</td> <td>INNER GLASS FIXING CAP</td> <td>1.000</td> <td>PC</td> </tr> <tr> <td>VM2305A0</td> <td>MM SERIES DOOR CAP FIXING PAWL</td> <td>4.000</td> <td>PC</td> </tr> </tbody> </table>	Code	Description	Qty	UOM	RC1200A0	ED=4 WIRE D=0.5 H24 COMPRESSIO N SPRING	2.000	PC	VE1030A1	MAGNET FOR DOOR MICROSWITC H D=22,9mm	1.000	PC	VI1220A1	4,2x12 TCB SELF-TAPPIN G SCREW	1.000	PC	VI1930A1	5x20 ST. STEEL CHIP SCREW	4.000	PC	VI1996A0	M5x35 SCREW	4.000	PC	VM2262B0	MM -M DOOR RIGHT UPPER CAP	1.000	PC	VM2267A0	INTERNAL GLASS LOCKING SYSTEM SLIDER	1.000	PC	VM2268A0	DOOR MAGNET COVER	1.000	PC	VM2269B0	INNER GLASS FIXING CAP	1.000	PC	VM2305A0	MM SERIES DOOR CAP FIXING PAWL	4.000	PC
Code	Description	Qty	UOM																																											
RC1200A0	ED=4 WIRE D=0.5 H24 COMPRESSIO N SPRING	2.000	PC																																											
VE1030A1	MAGNET FOR DOOR MICROSWITC H D=22,9mm	1.000	PC																																											
VI1220A1	4,2x12 TCB SELF-TAPPIN G SCREW	1.000	PC																																											
VI1930A1	5x20 ST. STEEL CHIP SCREW	4.000	PC																																											
VI1996A0	M5x35 SCREW	4.000	PC																																											
VM2262B0	MM -M DOOR RIGHT UPPER CAP	1.000	PC																																											
VM2267A0	INTERNAL GLASS LOCKING SYSTEM SLIDER	1.000	PC																																											
VM2268A0	DOOR MAGNET COVER	1.000	PC																																											
VM2269B0	INNER GLASS FIXING CAP	1.000	PC																																											
VM2305A0	MM SERIES DOOR CAP FIXING PAWL	4.000	PC																																											
KVM2261B	MIND.MAPS -M DOOR RIGHT LOWER CAP KIT	<table border="1"> <thead> <tr> <th>Code</th> <th>Description</th> <th>Qty</th> <th>UOM</th> </tr> </thead> <tbody> <tr> <td>RC1200A0</td> <td>ED=4 WIRE D=0.5 H24 COMPRESSIO N SPRING</td> <td>2.000</td> <td>PC</td> </tr> <tr> <td>VE1030A1</td> <td>MAGNET FOR DOOR MICROSWITC H D=22,9mm</td> <td>1.000</td> <td>PC</td> </tr> </tbody> </table>	Code	Description	Qty	UOM	RC1200A0	ED=4 WIRE D=0.5 H24 COMPRESSIO N SPRING	2.000	PC	VE1030A1	MAGNET FOR DOOR MICROSWITC H D=22,9mm	1.000	PC																																
Code	Description	Qty	UOM																																											
RC1200A0	ED=4 WIRE D=0.5 H24 COMPRESSIO N SPRING	2.000	PC																																											
VE1030A1	MAGNET FOR DOOR MICROSWITC H D=22,9mm	1.000	PC																																											

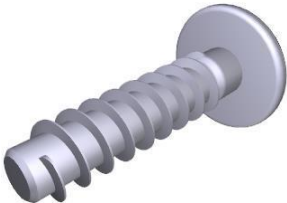
COMPONENT			SPARE PART																																						
Code	Description	Image	Code	Description	Kit components																																				
VM2267A	INTERNAL GLASS LOCKING SYSTEM SLIDER		KVM2261B	MIND.MAPS -M DOOR RIGHT LOWER CAP KIT	<table border="1"> <thead> <tr> <th>Code</th> <th>Description</th> <th>Qty</th> <th>UOM</th> </tr> </thead> <tbody> <tr> <td>V11220A1</td> <td>4,2x12 TCB SELF-TAPPING SCREW</td> <td>1.000</td> <td>PC</td> </tr> <tr> <td>V11930A1</td> <td>5x20 ST. STEEL CHIP SCREW</td> <td>4.000</td> <td>PC</td> </tr> <tr> <td>V11996A0</td> <td>M5x35 SCREW</td> <td>4.000</td> <td>PC</td> </tr> <tr> <td>VM2261B0</td> <td>MM -M DOOR RIGHT LOWER CAP</td> <td>1.000</td> <td>PC</td> </tr> <tr> <td>VM2267A0</td> <td>INTERNAL GLASS LOCKING SYSTEM SLIDER</td> <td>1.000</td> <td>PC</td> </tr> <tr> <td>VM2268A0</td> <td>DOOR MAGNET COVER</td> <td>1.000</td> <td>PC</td> </tr> <tr> <td>VM2269B0</td> <td>INNER GLASS FIXING CAP</td> <td>1.000</td> <td>PC</td> </tr> <tr> <td>VM2305A0</td> <td>MM SERIES DOOR CAP FIXING PAWL</td> <td>4.000</td> <td>PC</td> </tr> </tbody> </table>	Code	Description	Qty	UOM	V11220A1	4,2x12 TCB SELF-TAPPING SCREW	1.000	PC	V11930A1	5x20 ST. STEEL CHIP SCREW	4.000	PC	V11996A0	M5x35 SCREW	4.000	PC	VM2261B0	MM -M DOOR RIGHT LOWER CAP	1.000	PC	VM2267A0	INTERNAL GLASS LOCKING SYSTEM SLIDER	1.000	PC	VM2268A0	DOOR MAGNET COVER	1.000	PC	VM2269B0	INNER GLASS FIXING CAP	1.000	PC	VM2305A0	MM SERIES DOOR CAP FIXING PAWL	4.000	PC
Code	Description	Qty	UOM																																						
V11220A1	4,2x12 TCB SELF-TAPPING SCREW	1.000	PC																																						
V11930A1	5x20 ST. STEEL CHIP SCREW	4.000	PC																																						
V11996A0	M5x35 SCREW	4.000	PC																																						
VM2261B0	MM -M DOOR RIGHT LOWER CAP	1.000	PC																																						
VM2267A0	INTERNAL GLASS LOCKING SYSTEM SLIDER	1.000	PC																																						
VM2268A0	DOOR MAGNET COVER	1.000	PC																																						
VM2269B0	INNER GLASS FIXING CAP	1.000	PC																																						
VM2305A0	MM SERIES DOOR CAP FIXING PAWL	4.000	PC																																						
VM2268A	DOOR MAGNET COVER		KVM2268A	DOOR MAGNET COVER KIT	<table border="1"> <thead> <tr> <th>Code</th> <th>Description</th> <th>Qty</th> <th>UOM</th> </tr> </thead> <tbody> <tr> <td>VM2268A0</td> <td>DOOR MAGNET COVER</td> <td>1.000</td> <td>PC</td> </tr> </tbody> </table>	Code	Description	Qty	UOM	VM2268A0	DOOR MAGNET COVER	1.000	PC																												
Code	Description	Qty	UOM																																						
VM2268A0	DOOR MAGNET COVER	1.000	PC																																						
VM2269B	INNER GLASS FIXING CAP		KVM2269B	INNER GLASS FIXING CAP KIT -M	<table border="1"> <thead> <tr> <th>Code</th> <th>Description</th> <th>Qty</th> <th>UOM</th> </tr> </thead> <tbody> <tr> <td>VM2269B0</td> <td>INNER GLASS FIXING CAP</td> <td>2.000</td> <td>PC</td> </tr> </tbody> </table>	Code	Description	Qty	UOM	VM2269B0	INNER GLASS FIXING CAP	2.000	PC																												
Code	Description	Qty	UOM																																						
VM2269B0	INNER GLASS FIXING CAP	2.000	PC																																						
VM2305A	MM SERIES DOOR CAP FIXING PAWL		KVM2305A	MM FIXING DOOR THUB SCREWS 10 PCS KIT	<table border="1"> <thead> <tr> <th>Code</th> <th>Description</th> <th>Qty</th> <th>UOM</th> </tr> </thead> <tbody> <tr> <td>VM2305A0</td> <td>MM SERIES DOOR CAP FIXING PAWL</td> <td>10.000</td> <td>PC</td> </tr> </tbody> </table>	Code	Description	Qty	UOM	VM2305A0	MM SERIES DOOR CAP FIXING PAWL	10.000	PC																												
Code	Description	Qty	UOM																																						
VM2305A0	MM SERIES DOOR CAP FIXING PAWL	10.000	PC																																						



COMPONENT			SPARE PART																																		
Code	Description	Image	Code	Description	Kit components																																
VI1074A	4X16 SCREW FOR PLASTIC		VI1074A0	4X16 SCREW FOR PLASTIC																																	
VI1930A	5x20 ST. STEEL CHIP SCREW		VI1147A0	5X25 STAINLESS STEEL SCREW																																	
VI1996A	M5x35 SCREW		VI1996A0	M5x35 SCREW																																	
VM2260B	S6 LEFT UPPER CAP		KVM2260B	MM M RIGHT DOOR -LEFT UPPER CAP KI	<table border="1"> <thead> <tr> <th>Code</th> <th>Description</th> <th>Qty</th> <th>UOM</th> </tr> </thead> <tbody> <tr> <td>VI1103A0</td> <td>40X12 TBSP SCREW FOR PLASTIC</td> <td>1.000</td> <td>PC</td> </tr> <tr> <td>VI1930A1</td> <td>5x20 ST. STEEL CHIP SCREW</td> <td>4.000</td> <td>PC</td> </tr> <tr> <td>VI1996A0</td> <td>M5x35 SCREW</td> <td>2.000</td> <td>PC</td> </tr> <tr> <td>VM2260B0</td> <td>S6 LEFT UPPER CAP</td> <td>1.000</td> <td>PC</td> </tr> <tr> <td>VM2275A0</td> <td>SMOOTH BUSHING</td> <td>1.000</td> <td>PC</td> </tr> <tr> <td>VM2305A0</td> <td>MM SERIES DOOR CAP FIXING PAWL</td> <td>3.000</td> <td>PC</td> </tr> <tr> <td>VP1081A0</td> <td>UPPER HINGE CAP FOR UPPER INNER GLASS</td> <td>1.000</td> <td>PC</td> </tr> </tbody> </table>	Code	Description	Qty	UOM	VI1103A0	40X12 TBSP SCREW FOR PLASTIC	1.000	PC	VI1930A1	5x20 ST. STEEL CHIP SCREW	4.000	PC	VI1996A0	M5x35 SCREW	2.000	PC	VM2260B0	S6 LEFT UPPER CAP	1.000	PC	VM2275A0	SMOOTH BUSHING	1.000	PC	VM2305A0	MM SERIES DOOR CAP FIXING PAWL	3.000	PC	VP1081A0	UPPER HINGE CAP FOR UPPER INNER GLASS	1.000	PC
Code	Description	Qty	UOM																																		
VI1103A0	40X12 TBSP SCREW FOR PLASTIC	1.000	PC																																		
VI1930A1	5x20 ST. STEEL CHIP SCREW	4.000	PC																																		
VI1996A0	M5x35 SCREW	2.000	PC																																		
VM2260B0	S6 LEFT UPPER CAP	1.000	PC																																		
VM2275A0	SMOOTH BUSHING	1.000	PC																																		
VM2305A0	MM SERIES DOOR CAP FIXING PAWL	3.000	PC																																		
VP1081A0	UPPER HINGE CAP FOR UPPER INNER GLASS	1.000	PC																																		



COMPONENT			SPARE PART																																																														
Code	Description	Image	Code	Description	Kit components																																																												
VM2275A	SMOOTH BUSHING		KVM2275A	SMOOTH PIN BUSHING KIT	<table border="1"> <thead> <tr> <th>Code</th> <th>Description</th> <th>Qty</th> <th>UOM</th> </tr> </thead> <tbody> <tr> <td>VM2275A0</td> <td>SMOOTH BUSHING</td> <td>1.000</td> <td>PC</td> </tr> </tbody> </table>	Code	Description	Qty	UOM	VM2275A0	SMOOTH BUSHING	1.000	PC																																																				
Code	Description	Qty	UOM																																																														
VM2275A0	SMOOTH BUSHING	1.000	PC																																																														
VM2305A	MM SERIES DOOR CAP FIXING PAWL		KVM2305A	MM FIXING DOOR THUB SCREWS 10 PCS KIT	<table border="1"> <thead> <tr> <th>Code</th> <th>Description</th> <th>Qty</th> <th>UOM</th> </tr> </thead> <tbody> <tr> <td>VM2305A0</td> <td>MM SERIES DOOR CAP FIXING PAWL</td> <td>10.000</td> <td>PC</td> </tr> </tbody> </table>	Code	Description	Qty	UOM	VM2305A0	MM SERIES DOOR CAP FIXING PAWL	10.000	PC																																																				
Code	Description	Qty	UOM																																																														
VM2305A0	MM SERIES DOOR CAP FIXING PAWL	10.000	PC																																																														
VP1081A	UPPER HINGE CAP FOR UPPER INNER GLASS		<p>KVM2384B</p> <p>KVM2260B</p>	<p>MM- M LEFT DOOR RIGHT LOWER CAP KIT</p> <p>MM M RIGHT DOOR -LEFT UPPER CAP KI</p>	<table border="1"> <thead> <tr> <th>Code</th> <th>Description</th> <th>Qty</th> <th>UOM</th> </tr> </thead> <tbody> <tr> <td>VI1074A0</td> <td>4X16 SCREW FOR PLASTIC</td> <td>1.000</td> <td>PC</td> </tr> <tr> <td>VI1930A1</td> <td>5x20 ST. STEEL CHIP SCREW</td> <td>4.000</td> <td>PC</td> </tr> <tr> <td>VI1996A0</td> <td>M5x35 SCREW</td> <td>3.000</td> <td>PC</td> </tr> <tr> <td>VM2274A0</td> <td>GROOVED BUSHING</td> <td>1.000</td> <td>PC</td> </tr> <tr> <td>VM2305A0</td> <td>MM SERIES DOOR CAP FIXING PAWL</td> <td>3.000</td> <td>PC</td> </tr> <tr> <td>VM2384B0</td> <td>MM LEFT DOOR RIGHT LOWER CAP</td> <td>1.000</td> <td>PC</td> </tr> <tr> <td>VP1081A0</td> <td>UPPER HINGE CAP FOR UPPER INNER GLASS</td> <td>1.000</td> <td>PC</td> </tr> <tr> <td>VI1103A0</td> <td>40X12 TBSP SCREW FOR PLASTIC</td> <td>1.000</td> <td>PC</td> </tr> <tr> <td>VI1930A1</td> <td>5x20 ST. STEEL CHIP SCREW</td> <td>4.000</td> <td>PC</td> </tr> <tr> <td>VI1996A0</td> <td>M5x35 SCREW</td> <td>2.000</td> <td>PC</td> </tr> <tr> <td>VM2260B0</td> <td>S6 LEFT UPPER CAP</td> <td>1.000</td> <td>PC</td> </tr> <tr> <td>VM2275A0</td> <td>SMOOTH BUSHING</td> <td>1.000</td> <td>PC</td> </tr> <tr> <td>VM2305A0</td> <td>MM SERIES DOOR CAP FIXING PAWL</td> <td>3.000</td> <td>PC</td> </tr> <tr> <td>VP1081A0</td> <td>UPPER HINGE CAP FOR UPPER INNER GLASS</td> <td>1.000</td> <td>PC</td> </tr> </tbody> </table>	Code	Description	Qty	UOM	VI1074A0	4X16 SCREW FOR PLASTIC	1.000	PC	VI1930A1	5x20 ST. STEEL CHIP SCREW	4.000	PC	VI1996A0	M5x35 SCREW	3.000	PC	VM2274A0	GROOVED BUSHING	1.000	PC	VM2305A0	MM SERIES DOOR CAP FIXING PAWL	3.000	PC	VM2384B0	MM LEFT DOOR RIGHT LOWER CAP	1.000	PC	VP1081A0	UPPER HINGE CAP FOR UPPER INNER GLASS	1.000	PC	VI1103A0	40X12 TBSP SCREW FOR PLASTIC	1.000	PC	VI1930A1	5x20 ST. STEEL CHIP SCREW	4.000	PC	VI1996A0	M5x35 SCREW	2.000	PC	VM2260B0	S6 LEFT UPPER CAP	1.000	PC	VM2275A0	SMOOTH BUSHING	1.000	PC	VM2305A0	MM SERIES DOOR CAP FIXING PAWL	3.000	PC	VP1081A0	UPPER HINGE CAP FOR UPPER INNER GLASS	1.000	PC
Code	Description	Qty	UOM																																																														
VI1074A0	4X16 SCREW FOR PLASTIC	1.000	PC																																																														
VI1930A1	5x20 ST. STEEL CHIP SCREW	4.000	PC																																																														
VI1996A0	M5x35 SCREW	3.000	PC																																																														
VM2274A0	GROOVED BUSHING	1.000	PC																																																														
VM2305A0	MM SERIES DOOR CAP FIXING PAWL	3.000	PC																																																														
VM2384B0	MM LEFT DOOR RIGHT LOWER CAP	1.000	PC																																																														
VP1081A0	UPPER HINGE CAP FOR UPPER INNER GLASS	1.000	PC																																																														
VI1103A0	40X12 TBSP SCREW FOR PLASTIC	1.000	PC																																																														
VI1930A1	5x20 ST. STEEL CHIP SCREW	4.000	PC																																																														
VI1996A0	M5x35 SCREW	2.000	PC																																																														
VM2260B0	S6 LEFT UPPER CAP	1.000	PC																																																														
VM2275A0	SMOOTH BUSHING	1.000	PC																																																														
VM2305A0	MM SERIES DOOR CAP FIXING PAWL	3.000	PC																																																														
VP1081A0	UPPER HINGE CAP FOR UPPER INNER GLASS	1.000	PC																																																														



COMPONENT			SPARE PART																																		
Code	Description	Image	Code	Description	Kit components																																
VI1074A	4X16 SCREW FOR PLASTIC		VI1074A0	4X16 SCREW FOR PLASTIC																																	
VI1930A	5x20 ST. STEEL CHIP SCREW		VI1147A0	5X25 STAINLESS STEEL SCREW																																	
VI1996A	M5x35 SCREW		VI1996A0	M5x35 SCREW																																	
VM2259B	VM2259B0		KVM2259B	MM -M RIGHT DOOR LEFT LOWER CAP KI	<table border="1"> <thead> <tr> <th>Code</th> <th>Description</th> <th>Qty</th> <th>UOM</th> </tr> </thead> <tbody> <tr> <td>VI1103A0</td> <td>40X12 TBSP SCREW FOR PLASTIC</td> <td>1.000</td> <td>PC</td> </tr> <tr> <td>VI1930A1</td> <td>5x20 ST. STEEL CHIP SCREW</td> <td>4.000</td> <td>PC</td> </tr> <tr> <td>VI1996A0</td> <td>M5x35 SCREW</td> <td>3.000</td> <td>PC</td> </tr> <tr> <td>VM2259B0</td> <td>VM2259B0</td> <td>1.000</td> <td>PC</td> </tr> <tr> <td>VM2274A0</td> <td>GROOVED BUSHING</td> <td>1.000</td> <td>PC</td> </tr> <tr> <td>VM2305A0</td> <td>MM SERIES DOOR CAP FIXING PAWL</td> <td>3.000</td> <td>PC</td> </tr> <tr> <td>VP1080A0</td> <td>UPPER HINGE CAP FOR LOWER INNER GLASS</td> <td>1.000</td> <td>PC</td> </tr> </tbody> </table>	Code	Description	Qty	UOM	VI1103A0	40X12 TBSP SCREW FOR PLASTIC	1.000	PC	VI1930A1	5x20 ST. STEEL CHIP SCREW	4.000	PC	VI1996A0	M5x35 SCREW	3.000	PC	VM2259B0	VM2259B0	1.000	PC	VM2274A0	GROOVED BUSHING	1.000	PC	VM2305A0	MM SERIES DOOR CAP FIXING PAWL	3.000	PC	VP1080A0	UPPER HINGE CAP FOR LOWER INNER GLASS	1.000	PC
Code	Description	Qty	UOM																																		
VI1103A0	40X12 TBSP SCREW FOR PLASTIC	1.000	PC																																		
VI1930A1	5x20 ST. STEEL CHIP SCREW	4.000	PC																																		
VI1996A0	M5x35 SCREW	3.000	PC																																		
VM2259B0	VM2259B0	1.000	PC																																		
VM2274A0	GROOVED BUSHING	1.000	PC																																		
VM2305A0	MM SERIES DOOR CAP FIXING PAWL	3.000	PC																																		
VP1080A0	UPPER HINGE CAP FOR LOWER INNER GLASS	1.000	PC																																		

COMPONENT			SPARE PART																																																						
Code	Description	Image	Code	Description	Kit components																																																				
VM2274A	GROOVED BUSHING		KVM2274A	GROOVED PIN BUSHING KIT	<table border="1"> <thead> <tr> <th>Code</th> <th>Description</th> <th>Qty</th> <th>UOM</th> </tr> </thead> <tbody> <tr> <td>VM2274A0</td> <td>GROOVED BUSHING</td> <td>1.000</td> <td>PC</td> </tr> </tbody> </table>	Code	Description	Qty	UOM	VM2274A0	GROOVED BUSHING	1.000	PC																																												
Code	Description	Qty	UOM																																																						
VM2274A0	GROOVED BUSHING	1.000	PC																																																						
			K0B1126AR	BAKERTOP MM RIGHT DOOR LOWER BEAM KIT	<table border="1"> <thead> <tr> <th>Code</th> <th>Description</th> <th>Qty</th> <th>UOM</th> </tr> </thead> <tbody> <tr> <td>0B1126A1</td> <td>860mm DOOR LOWER FRAME SHAPE</td> <td>1.000</td> <td>PC</td> </tr> <tr> <td>RC1200A0</td> <td>ED=4 WIRE D=0.5 H24 COMPRESSIO N SPRING</td> <td>2.000</td> <td>PC</td> </tr> <tr> <td>VI1220A1</td> <td>4,2x12 TCB SELF-TAPPIN G SCREW</td> <td>1.000</td> <td>PC</td> </tr> <tr> <td>VI1996A0</td> <td>M5x35 SCREW</td> <td>7.000</td> <td>PC</td> </tr> <tr> <td>VM1794A0</td> <td>250x4.8 PA66 BLACK CLAMP</td> <td>2.000</td> <td>PC</td> </tr> <tr> <td>VM2103A0</td> <td>CLAMP LOCK</td> <td>2.000</td> <td>PC</td> </tr> <tr> <td>VM2259A1</td> <td>6 SERIES DOOR LOWER LEFT CAP</td> <td>1.000</td> <td>PC</td> </tr> <tr> <td>VM2261A1</td> <td>MM DOOR LOWER RIGHT CAP</td> <td>1.000</td> <td>PC</td> </tr> <tr> <td>VM2267A0</td> <td>INTERNAL GLASS LOCKING SYSTEM SLIDER</td> <td>1.000</td> <td>PC</td> </tr> <tr> <td>VM2269A0</td> <td>INTERNAL GLASS LOCKING SYSTEM CAP</td> <td>1.000</td> <td>PC</td> </tr> <tr> <td>VM2274A0</td> <td>GROOVED BUSHING</td> <td>1.000</td> <td>PC</td> </tr> <tr> <td>VM2305A0</td> <td>MM SERIES DOOR CAP FIXING PAWL</td> <td>7.000</td> <td>PC</td> </tr> </tbody> </table>	Code	Description	Qty	UOM	0B1126A1	860mm DOOR LOWER FRAME SHAPE	1.000	PC	RC1200A0	ED=4 WIRE D=0.5 H24 COMPRESSIO N SPRING	2.000	PC	VI1220A1	4,2x12 TCB SELF-TAPPIN G SCREW	1.000	PC	VI1996A0	M5x35 SCREW	7.000	PC	VM1794A0	250x4.8 PA66 BLACK CLAMP	2.000	PC	VM2103A0	CLAMP LOCK	2.000	PC	VM2259A1	6 SERIES DOOR LOWER LEFT CAP	1.000	PC	VM2261A1	MM DOOR LOWER RIGHT CAP	1.000	PC	VM2267A0	INTERNAL GLASS LOCKING SYSTEM SLIDER	1.000	PC	VM2269A0	INTERNAL GLASS LOCKING SYSTEM CAP	1.000	PC	VM2274A0	GROOVED BUSHING	1.000	PC	VM2305A0	MM SERIES DOOR CAP FIXING PAWL	7.000	PC
Code	Description	Qty	UOM																																																						
0B1126A1	860mm DOOR LOWER FRAME SHAPE	1.000	PC																																																						
RC1200A0	ED=4 WIRE D=0.5 H24 COMPRESSIO N SPRING	2.000	PC																																																						
VI1220A1	4,2x12 TCB SELF-TAPPIN G SCREW	1.000	PC																																																						
VI1996A0	M5x35 SCREW	7.000	PC																																																						
VM1794A0	250x4.8 PA66 BLACK CLAMP	2.000	PC																																																						
VM2103A0	CLAMP LOCK	2.000	PC																																																						
VM2259A1	6 SERIES DOOR LOWER LEFT CAP	1.000	PC																																																						
VM2261A1	MM DOOR LOWER RIGHT CAP	1.000	PC																																																						
VM2267A0	INTERNAL GLASS LOCKING SYSTEM SLIDER	1.000	PC																																																						
VM2269A0	INTERNAL GLASS LOCKING SYSTEM CAP	1.000	PC																																																						
VM2274A0	GROOVED BUSHING	1.000	PC																																																						
VM2305A0	MM SERIES DOOR CAP FIXING PAWL	7.000	PC																																																						
			K0B1126AL	EU AND 2/1 MM LEFT DOOR LOWER BEAM KIT	<table border="1"> <thead> <tr> <th>Code</th> <th>Description</th> <th>Qty</th> <th>UOM</th> </tr> </thead> <tbody> <tr> <td>0B1126A1</td> <td>860mm DOOR LOWER FRAME SHAPE</td> <td>1.000</td> <td>PC</td> </tr> <tr> <td>RC1200A0</td> <td>ED=4 WIRE D=0.5 H24 COMPRESSIO N SPRING</td> <td>2.000</td> <td>PC</td> </tr> <tr> <td>VI1220A1</td> <td>4,2x12 TCB SELF-TAPPIN G SCREW</td> <td>1.000</td> <td>PC</td> </tr> <tr> <td>VI1996A0</td> <td>M5x35 SCREW</td> <td>7.000</td> <td>PC</td> </tr> <tr> <td>VM1794A0</td> <td>250x4.8 PA66 BLACK CLAMP</td> <td>2.000</td> <td>PC</td> </tr> <tr> <td>VM2103A0</td> <td>CLAMP LOCK</td> <td>2.000</td> <td>PC</td> </tr> </tbody> </table>	Code	Description	Qty	UOM	0B1126A1	860mm DOOR LOWER FRAME SHAPE	1.000	PC	RC1200A0	ED=4 WIRE D=0.5 H24 COMPRESSIO N SPRING	2.000	PC	VI1220A1	4,2x12 TCB SELF-TAPPIN G SCREW	1.000	PC	VI1996A0	M5x35 SCREW	7.000	PC	VM1794A0	250x4.8 PA66 BLACK CLAMP	2.000	PC	VM2103A0	CLAMP LOCK	2.000	PC																								
Code	Description	Qty	UOM																																																						
0B1126A1	860mm DOOR LOWER FRAME SHAPE	1.000	PC																																																						
RC1200A0	ED=4 WIRE D=0.5 H24 COMPRESSIO N SPRING	2.000	PC																																																						
VI1220A1	4,2x12 TCB SELF-TAPPIN G SCREW	1.000	PC																																																						
VI1996A0	M5x35 SCREW	7.000	PC																																																						
VM1794A0	250x4.8 PA66 BLACK CLAMP	2.000	PC																																																						
VM2103A0	CLAMP LOCK	2.000	PC																																																						





COMPONENT			SPARE PART																																																			
Code	Description	Image	Code	Description	Kit components																																																	
VM2274A	GROOVED BUSHING		K0B1126AL	EU AND 2/1 MM LEFT DOOR LOWER BEAM KIT	<table border="1"> <thead> <tr> <th>Code</th> <th>Description</th> <th>Qty</th> <th>UOM</th> </tr> </thead> <tbody> <tr> <td>VM2267A0</td> <td>INTERNAL GLASS LOCKING SYSTEM SLIDER</td> <td>1.000</td> <td>PC</td> </tr> <tr> <td>VM2269A0</td> <td>INTERNAL GLASS LOCKING SYSTEM CAP</td> <td>1.000</td> <td>PC</td> </tr> <tr> <td>VM2274A0</td> <td>GROOVED BUSHING</td> <td>1.000</td> <td>PC</td> </tr> <tr> <td>VM2305A0</td> <td>MM SERIES DOOR CAP FIXING PAWL</td> <td>7.000</td> <td>PC</td> </tr> <tr> <td>VM2384A0</td> <td>MM LEFT DOOR RIGHT LOWER CAP</td> <td>1.000</td> <td>PC</td> </tr> <tr> <td>VM2386A1</td> <td>LEFT MM DOOR LOWER LEFT CAP</td> <td>1.000</td> <td>PC</td> </tr> </tbody> </table>	Code	Description	Qty	UOM	VM2267A0	INTERNAL GLASS LOCKING SYSTEM SLIDER	1.000	PC	VM2269A0	INTERNAL GLASS LOCKING SYSTEM CAP	1.000	PC	VM2274A0	GROOVED BUSHING	1.000	PC	VM2305A0	MM SERIES DOOR CAP FIXING PAWL	7.000	PC	VM2384A0	MM LEFT DOOR RIGHT LOWER CAP	1.000	PC	VM2386A1	LEFT MM DOOR LOWER LEFT CAP	1.000	PC																					
			Code	Description	Qty	UOM																																																
VM2267A0	INTERNAL GLASS LOCKING SYSTEM SLIDER	1.000	PC																																																			
VM2269A0	INTERNAL GLASS LOCKING SYSTEM CAP	1.000	PC																																																			
VM2274A0	GROOVED BUSHING	1.000	PC																																																			
VM2305A0	MM SERIES DOOR CAP FIXING PAWL	7.000	PC																																																			
VM2384A0	MM LEFT DOOR RIGHT LOWER CAP	1.000	PC																																																			
VM2386A1	LEFT MM DOOR LOWER LEFT CAP	1.000	PC																																																			
K0B1122AR	CHEFTOP MM RIGHT DOOR LOWER BEAM KIT	<table border="1"> <thead> <tr> <th>Code</th> <th>Description</th> <th>Qty</th> <th>UOM</th> </tr> </thead> <tbody> <tr> <td>0B1122A1</td> <td>750MM DOOR LOWER FRAME SHAPE</td> <td>1.000</td> <td>PC</td> </tr> <tr> <td>RC1200A0</td> <td>ED=4 WIRE D=0.5 H24 COMPRESSIO N SPRING</td> <td>2.000</td> <td>PC</td> </tr> <tr> <td>VI1220A1</td> <td>4,2x12 TCB SELF-TAPPIN G SCREW</td> <td>1.000</td> <td>PC</td> </tr> <tr> <td>VI1996A0</td> <td>M5x35 SCREW</td> <td>7.000</td> <td>PC</td> </tr> <tr> <td>VM1794A0</td> <td>250x4.8 PA66 BLACK CLAMP</td> <td>2.000</td> <td>PC</td> </tr> <tr> <td>VM2103A0</td> <td>CLAMP LOCK</td> <td>2.000</td> <td>PC</td> </tr> <tr> <td>VM2259A1</td> <td>6 SERIES DOOR LOWER LEFT CAP</td> <td>1.000</td> <td>PC</td> </tr> <tr> <td>VM2261A1</td> <td>MM DOOR LOWER RIGHT CAP</td> <td>1.000</td> <td>PC</td> </tr> <tr> <td>VM2267A0</td> <td>INTERNAL GLASS LOCKING SYSTEM SLIDER</td> <td>1.000</td> <td>PC</td> </tr> <tr> <td>VM2269A0</td> <td>INTERNAL GLASS LOCKING SYSTEM CAP</td> <td>1.000</td> <td>PC</td> </tr> <tr> <td>VM2274A0</td> <td>GROOVED BUSHING</td> <td>1.000</td> <td>PC</td> </tr> <tr> <td>VM2305A0</td> <td>MM SERIES DOOR CAP FIXING PAWL</td> <td>7.000</td> <td>PC</td> </tr> </tbody> </table>	Code	Description	Qty	UOM	0B1122A1	750MM DOOR LOWER FRAME SHAPE	1.000	PC	RC1200A0	ED=4 WIRE D=0.5 H24 COMPRESSIO N SPRING	2.000	PC	VI1220A1	4,2x12 TCB SELF-TAPPIN G SCREW	1.000	PC	VI1996A0	M5x35 SCREW	7.000	PC	VM1794A0	250x4.8 PA66 BLACK CLAMP	2.000	PC	VM2103A0	CLAMP LOCK	2.000	PC	VM2259A1	6 SERIES DOOR LOWER LEFT CAP	1.000	PC	VM2261A1	MM DOOR LOWER RIGHT CAP	1.000	PC	VM2267A0	INTERNAL GLASS LOCKING SYSTEM SLIDER	1.000	PC	VM2269A0	INTERNAL GLASS LOCKING SYSTEM CAP	1.000	PC	VM2274A0	GROOVED BUSHING	1.000	PC	VM2305A0	MM SERIES DOOR CAP FIXING PAWL	7.000	PC
Code	Description	Qty	UOM																																																			
0B1122A1	750MM DOOR LOWER FRAME SHAPE	1.000	PC																																																			
RC1200A0	ED=4 WIRE D=0.5 H24 COMPRESSIO N SPRING	2.000	PC																																																			
VI1220A1	4,2x12 TCB SELF-TAPPIN G SCREW	1.000	PC																																																			
VI1996A0	M5x35 SCREW	7.000	PC																																																			
VM1794A0	250x4.8 PA66 BLACK CLAMP	2.000	PC																																																			
VM2103A0	CLAMP LOCK	2.000	PC																																																			
VM2259A1	6 SERIES DOOR LOWER LEFT CAP	1.000	PC																																																			
VM2261A1	MM DOOR LOWER RIGHT CAP	1.000	PC																																																			
VM2267A0	INTERNAL GLASS LOCKING SYSTEM SLIDER	1.000	PC																																																			
VM2269A0	INTERNAL GLASS LOCKING SYSTEM CAP	1.000	PC																																																			
VM2274A0	GROOVED BUSHING	1.000	PC																																																			
VM2305A0	MM SERIES DOOR CAP FIXING PAWL	7.000	PC																																																			

COMPONENT			SPARE PART																																																						
Code	Description	Image	Code	Description	Kit components																																																				
VM2274A	GROOVED BUSHING		K0B1122AL	CHEFTOP MM LEFT DOOR LOWER BEAM KIT	<table border="1"> <thead> <tr> <th>Code</th> <th>Description</th> <th>Qty</th> <th>UOM</th> </tr> </thead> <tbody> <tr> <td>0B1122A1</td> <td>750MM DOOR LOWER FRAME SHAPE</td> <td>1.000</td> <td>PC</td> </tr> <tr> <td>RC1200A0</td> <td>ED=4 WIRE D=0.5 H24 COMPRESSIO N SPRING</td> <td>2.000</td> <td>PC</td> </tr> <tr> <td>V11220A1</td> <td>4,2x12 TOB SELF-TAPPIN G SCREW</td> <td>1.000</td> <td>PC</td> </tr> <tr> <td>V11996A0</td> <td>M5x35 SCREW</td> <td>7.000</td> <td>PC</td> </tr> <tr> <td>VM1794A0</td> <td>250x4.8 PA66 BLACK CLAMP</td> <td>2.000</td> <td>PC</td> </tr> <tr> <td>VM2103A0</td> <td>CLAMP LOCK</td> <td>2.000</td> <td>PC</td> </tr> <tr> <td>VM2267A0</td> <td>INTERNAL GLASS LOCKING SYSTEM SLIDER</td> <td>1.000</td> <td>PC</td> </tr> <tr> <td>VM2269A0</td> <td>INTERNAL GLASS LOCKING SYSTEM CAP</td> <td>1.000</td> <td>PC</td> </tr> <tr> <td>VM2274A0</td> <td>GROOVED BUSHING</td> <td>1.000</td> <td>PC</td> </tr> <tr> <td>VM2305A0</td> <td>MM SERIES DOOR CAP FIXING PAWL</td> <td>7.000</td> <td>PC</td> </tr> <tr> <td>VM2384A0</td> <td>MM LEFT DOOR RIGHT LOWER CAP</td> <td>1.000</td> <td>PC</td> </tr> <tr> <td>VM2386A1</td> <td>LEFT MM DOOR LOWER LEFT CAP</td> <td>1.000</td> <td>PC</td> </tr> </tbody> </table>	Code	Description	Qty	UOM	0B1122A1	750MM DOOR LOWER FRAME SHAPE	1.000	PC	RC1200A0	ED=4 WIRE D=0.5 H24 COMPRESSIO N SPRING	2.000	PC	V11220A1	4,2x12 TOB SELF-TAPPIN G SCREW	1.000	PC	V11996A0	M5x35 SCREW	7.000	PC	VM1794A0	250x4.8 PA66 BLACK CLAMP	2.000	PC	VM2103A0	CLAMP LOCK	2.000	PC	VM2267A0	INTERNAL GLASS LOCKING SYSTEM SLIDER	1.000	PC	VM2269A0	INTERNAL GLASS LOCKING SYSTEM CAP	1.000	PC	VM2274A0	GROOVED BUSHING	1.000	PC	VM2305A0	MM SERIES DOOR CAP FIXING PAWL	7.000	PC	VM2384A0	MM LEFT DOOR RIGHT LOWER CAP	1.000	PC	VM2386A1	LEFT MM DOOR LOWER LEFT CAP	1.000	PC
Code	Description	Qty	UOM																																																						
0B1122A1	750MM DOOR LOWER FRAME SHAPE	1.000	PC																																																						
RC1200A0	ED=4 WIRE D=0.5 H24 COMPRESSIO N SPRING	2.000	PC																																																						
V11220A1	4,2x12 TOB SELF-TAPPIN G SCREW	1.000	PC																																																						
V11996A0	M5x35 SCREW	7.000	PC																																																						
VM1794A0	250x4.8 PA66 BLACK CLAMP	2.000	PC																																																						
VM2103A0	CLAMP LOCK	2.000	PC																																																						
VM2267A0	INTERNAL GLASS LOCKING SYSTEM SLIDER	1.000	PC																																																						
VM2269A0	INTERNAL GLASS LOCKING SYSTEM CAP	1.000	PC																																																						
VM2274A0	GROOVED BUSHING	1.000	PC																																																						
VM2305A0	MM SERIES DOOR CAP FIXING PAWL	7.000	PC																																																						
VM2384A0	MM LEFT DOOR RIGHT LOWER CAP	1.000	PC																																																						
VM2386A1	LEFT MM DOOR LOWER LEFT CAP	1.000	PC																																																						
VM2305A	MM SERIES DOOR CAP FIXING PAWL		KVM2305A	MM FIXING DOOR THUB SCREWS 10 PCS KIT	<table border="1"> <thead> <tr> <th>Code</th> <th>Description</th> <th>Qty</th> <th>UOM</th> </tr> </thead> <tbody> <tr> <td>VM2305A0</td> <td>MM SERIES DOOR CAP FIXING PAWL</td> <td>10.000</td> <td>PC</td> </tr> </tbody> </table>	Code	Description	Qty	UOM	VM2305A0	MM SERIES DOOR CAP FIXING PAWL	10.000	PC																																												
Code	Description	Qty	UOM																																																						
VM2305A0	MM SERIES DOOR CAP FIXING PAWL	10.000	PC																																																						
VP1080A	UPPER HINGE CAP FOR LOWER INNER GLASS		KVM2383B	MM -M LEFT DOOR RIGHT UPPER CAP KIT	<table border="1"> <thead> <tr> <th>Code</th> <th>Description</th> <th>Qty</th> <th>UOM</th> </tr> </thead> <tbody> <tr> <td>V11074A0</td> <td>4X16 SCREW FOR PLASTIC</td> <td>1.000</td> <td>PC</td> </tr> <tr> <td>V11930A1</td> <td>5x20 ST. STEEL CHIP SCREW</td> <td>4.000</td> <td>PC</td> </tr> <tr> <td>V11996A0</td> <td>M5x35 SCREW</td> <td>3.000</td> <td>PC</td> </tr> <tr> <td>VM2275A0</td> <td>SMOOTH BUSHING</td> <td>1.000</td> <td>PC</td> </tr> </tbody> </table>	Code	Description	Qty	UOM	V11074A0	4X16 SCREW FOR PLASTIC	1.000	PC	V11930A1	5x20 ST. STEEL CHIP SCREW	4.000	PC	V11996A0	M5x35 SCREW	3.000	PC	VM2275A0	SMOOTH BUSHING	1.000	PC																																
Code	Description	Qty	UOM																																																						
V11074A0	4X16 SCREW FOR PLASTIC	1.000	PC																																																						
V11930A1	5x20 ST. STEEL CHIP SCREW	4.000	PC																																																						
V11996A0	M5x35 SCREW	3.000	PC																																																						
VM2275A0	SMOOTH BUSHING	1.000	PC																																																						







COMPONENT			SPARE PART																															
Code	Description	Image	Code	Description	Kit components																													
VP1080A	UPPER HINGE CAP FOR LOWER INNER GLASS		KVM2383B	MM -M LEFT DOOR RIGHT UPPER CAP KIT	<table border="1"> <thead> <tr> <th>Code</th> <th>Description</th> <th>Qty</th> <th>UOM</th> </tr> </thead> <tbody> <tr> <td>VM2305A0</td> <td>MM SERIES DOOR CAP FIXING PAWL</td> <td>3.000</td> <td>PC</td> </tr> <tr> <td>VM2383B0</td> <td>MM LEFT DOOR UPPER RIGHT CAP</td> <td>1.000</td> <td>PC</td> </tr> <tr> <td>VP1080A0</td> <td>UPPER HINGE CAP FOR LOWER INNER GLASS</td> <td>1.000</td> <td>PC</td> </tr> </tbody> </table>	Code	Description	Qty	UOM	VM2305A0	MM SERIES DOOR CAP FIXING PAWL	3.000	PC	VM2383B0	MM LEFT DOOR UPPER RIGHT CAP	1.000	PC	VP1080A0	UPPER HINGE CAP FOR LOWER INNER GLASS	1.000	PC													
			Code	Description	Qty	UOM																												
VM2305A0	MM SERIES DOOR CAP FIXING PAWL	3.000	PC																															
VM2383B0	MM LEFT DOOR UPPER RIGHT CAP	1.000	PC																															
VP1080A0	UPPER HINGE CAP FOR LOWER INNER GLASS	1.000	PC																															
KVM2259B	MM -M RIGHT DOOR LEFT LOWER CAP KI	<table border="1"> <thead> <tr> <th>Code</th> <th>Description</th> <th>Qty</th> <th>UOM</th> </tr> </thead> <tbody> <tr> <td>V11103A0</td> <td>40X12 TBSP SCREW FOR PLASTIC</td> <td>1.000</td> <td>PC</td> </tr> <tr> <td>V11930A1</td> <td>5x20 ST. STEEL CHIP SCREW</td> <td>4.000</td> <td>PC</td> </tr> <tr> <td>V11996A0</td> <td>M5x35 SCREW</td> <td>3.000</td> <td>PC</td> </tr> <tr> <td>VM2259B0</td> <td>VM2259B0</td> <td>1.000</td> <td>PC</td> </tr> <tr> <td>VM2274A0</td> <td>GROOVED BUSHING</td> <td>1.000</td> <td>PC</td> </tr> <tr> <td>VM2305A0</td> <td>MM SERIES DOOR CAP FIXING PAWL</td> <td>3.000</td> <td>PC</td> </tr> <tr> <td>VP1080A0</td> <td>UPPER HINGE CAP FOR LOWER INNER GLASS</td> <td>1.000</td> <td>PC</td> </tr> </tbody> </table>	Code	Description	Qty	UOM	V11103A0	40X12 TBSP SCREW FOR PLASTIC	1.000	PC	V11930A1	5x20 ST. STEEL CHIP SCREW	4.000	PC	V11996A0	M5x35 SCREW	3.000	PC	VM2259B0	VM2259B0	1.000	PC	VM2274A0	GROOVED BUSHING	1.000	PC	VM2305A0	MM SERIES DOOR CAP FIXING PAWL	3.000	PC	VP1080A0	UPPER HINGE CAP FOR LOWER INNER GLASS	1.000	PC
Code	Description	Qty	UOM																															
V11103A0	40X12 TBSP SCREW FOR PLASTIC	1.000	PC																															
V11930A1	5x20 ST. STEEL CHIP SCREW	4.000	PC																															
V11996A0	M5x35 SCREW	3.000	PC																															
VM2259B0	VM2259B0	1.000	PC																															
VM2274A0	GROOVED BUSHING	1.000	PC																															
VM2305A0	MM SERIES DOOR CAP FIXING PAWL	3.000	PC																															
VP1080A0	UPPER HINGE CAP FOR LOWER INNER GLASS	1.000	PC																															
VM2285B	860 SERIES DRIP PROFILE KIT		KVM2285B	860 -M SERIES DRIP PROFILE KIT	<table border="1"> <thead> <tr> <th>Code</th> <th>Description</th> <th>Qty</th> <th>UOM</th> </tr> </thead> <tbody> <tr> <td>VM2285B0</td> <td>860 SERIES DRIP PROFILE KIT</td> <td>1.000</td> <td>PC</td> </tr> </tbody> </table>	Code	Description	Qty	UOM	VM2285B0	860 SERIES DRIP PROFILE KIT	1.000	PC																					
Code	Description	Qty	UOM																															
VM2285B0	860 SERIES DRIP PROFILE KIT	1.000	PC																															
VM2312A	MM DRIP PROFILE DRAIN LEFT PIPE		KVM2312A	M.M. DRIP TRAY LEFT DRAIN PIPE KI	<table border="1"> <thead> <tr> <th>Code</th> <th>Description</th> <th>Qty</th> <th>UOM</th> </tr> </thead> <tbody> <tr> <td>V11220A1</td> <td>4,2x12 TCB SELF-TAPPIN G SCREW</td> <td>1.000</td> <td>PC</td> </tr> <tr> <td>VM2312A0</td> <td>MM DRIP PROFILE DRAIN LEFT PIPE</td> <td>1.000</td> <td>PC</td> </tr> </tbody> </table>	Code	Description	Qty	UOM	V11220A1	4,2x12 TCB SELF-TAPPIN G SCREW	1.000	PC	VM2312A0	MM DRIP PROFILE DRAIN LEFT PIPE	1.000	PC																	
Code	Description	Qty	UOM																															
V11220A1	4,2x12 TCB SELF-TAPPIN G SCREW	1.000	PC																															
VM2312A0	MM DRIP PROFILE DRAIN LEFT PIPE	1.000	PC																															



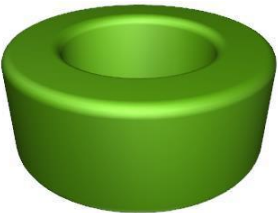

COMPONENT			SPARE PART																		
Code	Description	Image	Code	Description	Kit components																
VM2314A	MM DRIP PROFILE CAP		KVM2314A	MIND.Maps DRIP TRAY CAP	<table border="1"> <thead> <tr> <th>Code</th> <th>Description</th> <th>Qty</th> <th>UOM</th> </tr> </thead> <tbody> <tr> <td>GN1525A0</td> <td>O-RING INT DIAM 9,5 THK 1 NBR 70</td> <td>1.000</td> <td>PC</td> </tr> <tr> <td>V1103A0</td> <td>40X12 TBSP SCREW FOR PLASTIC</td> <td>1.000</td> <td>PC</td> </tr> <tr> <td>VM2314A0</td> <td>MM DRIP PROFILE CAP</td> <td>1.000</td> <td>PC</td> </tr> </tbody> </table>	Code	Description	Qty	UOM	GN1525A0	O-RING INT DIAM 9,5 THK 1 NBR 70	1.000	PC	V1103A0	40X12 TBSP SCREW FOR PLASTIC	1.000	PC	VM2314A0	MM DRIP PROFILE CAP	1.000	PC
Code	Description	Qty	UOM																		
GN1525A0	O-RING INT DIAM 9,5 THK 1 NBR 70	1.000	PC																		
V1103A0	40X12 TBSP SCREW FOR PLASTIC	1.000	PC																		
VM2314A0	MM DRIP PROFILE CAP	1.000	PC																		
VM1631A	PLUS INNER GLASS PUSHING CAP		KVM1631A	CAP FOR INTERNAL GLASS 10 PCS KIT	<table border="1"> <thead> <tr> <th>Code</th> <th>Description</th> <th>Qty</th> <th>UOM</th> </tr> </thead> <tbody> <tr> <td>VM1631A0</td> <td>PLUS INNER GLASS PUSHING CAP</td> <td>10.000</td> <td>PC</td> </tr> </tbody> </table>	Code	Description	Qty	UOM	VM1631A0	PLUS INNER GLASS PUSHING CAP	10.000	PC								
Code	Description	Qty	UOM																		
VM1631A0	PLUS INNER GLASS PUSHING CAP	10.000	PC																		
VM2505B	MM PLUS INTERNAL GLASS SUPPORT		KVM2505B	CAP FOR INTERNAL DOUBLE GLASS 3PCS KIT	<table border="1"> <thead> <tr> <th>Code</th> <th>Description</th> <th>Qty</th> <th>UOM</th> </tr> </thead> <tbody> <tr> <td>V11220A1</td> <td>4,2x12 TCB SELF-TAPPIN G SCREW</td> <td>3.000</td> <td>PC</td> </tr> <tr> <td>VM1631A0</td> <td>PLUS INNER GLASS PUSHING CAP</td> <td>3.000</td> <td>PC</td> </tr> <tr> <td>VM2505B1</td> <td>MM PLUS INTERNAL GLASS SUPPORT</td> <td>3.000</td> <td>PC</td> </tr> </tbody> </table>	Code	Description	Qty	UOM	V11220A1	4,2x12 TCB SELF-TAPPIN G SCREW	3.000	PC	VM1631A0	PLUS INNER GLASS PUSHING CAP	3.000	PC	VM2505B1	MM PLUS INTERNAL GLASS SUPPORT	3.000	PC
Code	Description	Qty	UOM																		
V11220A1	4,2x12 TCB SELF-TAPPIN G SCREW	3.000	PC																		
VM1631A0	PLUS INNER GLASS PUSHING CAP	3.000	PC																		
VM2505B1	MM PLUS INTERNAL GLASS SUPPORT	3.000	PC																		
VM2518A	BOARD COOLING FAN SUPPORT		KVM2518A	PANEL COOLING FAN SUPPORT KIT	<table border="1"> <thead> <tr> <th>Code</th> <th>Description</th> <th>Qty</th> <th>UOM</th> </tr> </thead> <tbody> <tr> <td>VM2518A0</td> <td>BOARD COOLING FAN SUPPORT</td> <td>1.000</td> <td>PC</td> </tr> </tbody> </table>	Code	Description	Qty	UOM	VM2518A0	BOARD COOLING FAN SUPPORT	1.000	PC								
Code	Description	Qty	UOM																		
VM2518A0	BOARD COOLING FAN SUPPORT	1.000	PC																		
VN1179A	CONTROL BOARD 40x40x20mm 12V COOLING FAN		KVN1179A	CONTROL BOARD COOLING FAN KIT	<table border="1"> <thead> <tr> <th>Code</th> <th>Description</th> <th>Qty</th> <th>UOM</th> </tr> </thead> <tbody> <tr> <td>VN1179A1</td> <td>CONTROL BOARD 40x40x20mm 12V COOLING FAN</td> <td>1.000</td> <td>PC</td> </tr> </tbody> </table>	Code	Description	Qty	UOM	VN1179A1	CONTROL BOARD 40x40x20mm 12V COOLING FAN	1.000	PC								
Code	Description	Qty	UOM																		
VN1179A1	CONTROL BOARD 40x40x20mm 12V COOLING FAN	1.000	PC																		

COMPONENT			SPARE PART																																										
Code	Description	Image	Code	Description	Kit components																																								
CR1105A	HINGES INTERNAL GLASS DOUBLE		KCR1105A	MIND.Maps PLUS INTERNAL GLASS HINGES KIT	<table border="1"> <thead> <tr> <th>Code</th> <th>Description</th> <th>Qty</th> <th>UOM</th> </tr> </thead> <tbody> <tr> <td>CR1105A0</td> <td>HINGES INTERNAL GLASS DOUBL</td> <td>1.000</td> <td>PC</td> </tr> <tr> <td>CR1106A0</td> <td>HINGES INTERNAL GLASS DOUBL</td> <td>1.000</td> <td>PC</td> </tr> <tr> <td>VI1220A1</td> <td>4,2x12 TCB SELF-TAPPIN G SCREW</td> <td>4.000</td> <td>PC</td> </tr> </tbody> </table>	Code	Description	Qty	UOM	CR1105A0	HINGES INTERNAL GLASS DOUBL	1.000	PC	CR1106A0	HINGES INTERNAL GLASS DOUBL	1.000	PC	VI1220A1	4,2x12 TCB SELF-TAPPIN G SCREW	4.000	PC																								
Code	Description	Qty	UOM																																										
CR1105A0	HINGES INTERNAL GLASS DOUBL	1.000	PC																																										
CR1106A0	HINGES INTERNAL GLASS DOUBL	1.000	PC																																										
VI1220A1	4,2x12 TCB SELF-TAPPIN G SCREW	4.000	PC																																										
CR1106A	HINGES INTERNAL GLASS DOUBLE		KCR1105A	MIND.Maps PLUS INTERNAL GLASS HINGES KIT	<table border="1"> <thead> <tr> <th>Code</th> <th>Description</th> <th>Qty</th> <th>UOM</th> </tr> </thead> <tbody> <tr> <td>CR1105A0</td> <td>HINGES INTERNAL GLASS DOUBL</td> <td>1.000</td> <td>PC</td> </tr> <tr> <td>CR1106A0</td> <td>HINGES INTERNAL GLASS DOUBL</td> <td>1.000</td> <td>PC</td> </tr> <tr> <td>VI1220A1</td> <td>4,2x12 TCB SELF-TAPPIN G SCREW</td> <td>4.000</td> <td>PC</td> </tr> </tbody> </table>	Code	Description	Qty	UOM	CR1105A0	HINGES INTERNAL GLASS DOUBL	1.000	PC	CR1106A0	HINGES INTERNAL GLASS DOUBL	1.000	PC	VI1220A1	4,2x12 TCB SELF-TAPPIN G SCREW	4.000	PC																								
Code	Description	Qty	UOM																																										
CR1105A0	HINGES INTERNAL GLASS DOUBL	1.000	PC																																										
CR1106A0	HINGES INTERNAL GLASS DOUBL	1.000	PC																																										
VI1220A1	4,2x12 TCB SELF-TAPPIN G SCREW	4.000	PC																																										
VT1296B	04EU 749x454x4 INNER DOUBLE GLASS		KVT1296B	04EU INNER DOUBLE GLASS KIT	<table border="1"> <thead> <tr> <th>Code</th> <th>Description</th> <th>Qty</th> <th>UOM</th> </tr> </thead> <tbody> <tr> <td>0B1181A0</td> <td>0511 DOUBLE GLASS RIGHT-LEFT PROFILE</td> <td>2.000</td> <td>PC</td> </tr> <tr> <td>0B1185A0</td> <td>BT INT DOUBLE GLASS INF-SUP BEAM</td> <td>2.000</td> <td>PC</td> </tr> <tr> <td>0B1211A1</td> <td>BT DOUBLE GLASS UPPER-LOWE R EXT PROFIL</td> <td>2.000</td> <td>PC</td> </tr> <tr> <td>0B1212A3</td> <td>0511 DOUBLE GLASS EXT RIGHT-LEFT PROFILE</td> <td>2.000</td> <td>PC</td> </tr> <tr> <td>CR1105A0</td> <td>HINGES INTERNAL GLASS DOUBL</td> <td>1.000</td> <td>PC</td> </tr> <tr> <td>CR1106A0</td> <td>HINGES INTERNAL GLASS DOUBL</td> <td>1.000</td> <td>PC</td> </tr> <tr> <td>VI1220A1</td> <td>4,2x12 TCB SELF-TAPPIN G SCREW</td> <td>4.000</td> <td>PC</td> </tr> <tr> <td>VI1225A0</td> <td>STAINLESS STEEL STRUCTURE RIVET 4x10.1</td> <td>20.000</td> <td>PC</td> </tr> <tr> <td>VT1296B0</td> <td>04EU 749x454x4 INNER DOUBLE GLAS</td> <td>2.000</td> <td>PC</td> </tr> </tbody> </table>	Code	Description	Qty	UOM	0B1181A0	0511 DOUBLE GLASS RIGHT-LEFT PROFILE	2.000	PC	0B1185A0	BT INT DOUBLE GLASS INF-SUP BEAM	2.000	PC	0B1211A1	BT DOUBLE GLASS UPPER-LOWE R EXT PROFIL	2.000	PC	0B1212A3	0511 DOUBLE GLASS EXT RIGHT-LEFT PROFILE	2.000	PC	CR1105A0	HINGES INTERNAL GLASS DOUBL	1.000	PC	CR1106A0	HINGES INTERNAL GLASS DOUBL	1.000	PC	VI1220A1	4,2x12 TCB SELF-TAPPIN G SCREW	4.000	PC	VI1225A0	STAINLESS STEEL STRUCTURE RIVET 4x10.1	20.000	PC	VT1296B0	04EU 749x454x4 INNER DOUBLE GLAS	2.000	PC
Code	Description	Qty	UOM																																										
0B1181A0	0511 DOUBLE GLASS RIGHT-LEFT PROFILE	2.000	PC																																										
0B1185A0	BT INT DOUBLE GLASS INF-SUP BEAM	2.000	PC																																										
0B1211A1	BT DOUBLE GLASS UPPER-LOWE R EXT PROFIL	2.000	PC																																										
0B1212A3	0511 DOUBLE GLASS EXT RIGHT-LEFT PROFILE	2.000	PC																																										
CR1105A0	HINGES INTERNAL GLASS DOUBL	1.000	PC																																										
CR1106A0	HINGES INTERNAL GLASS DOUBL	1.000	PC																																										
VI1220A1	4,2x12 TCB SELF-TAPPIN G SCREW	4.000	PC																																										
VI1225A0	STAINLESS STEEL STRUCTURE RIVET 4x10.1	20.000	PC																																										
VT1296B0	04EU 749x454x4 INNER DOUBLE GLAS	2.000	PC																																										



COMPONENT			SPARE PART																		
Code	Description	Image	Code	Description	Kit components																
CE1097A	4M SIHF 4 POLES MICROFIT CANBUS		KCE1097A	POWER-CONTROL 4POLES 4M BUS CABLE KIT	<table border="1"> <thead> <tr> <th>Code</th> <th>Description</th> <th>Qty</th> <th>UOM</th> </tr> </thead> <tbody> <tr> <td>CE1097A0</td> <td>4M SIHF 4 POLES MICROFIT CANBUS</td> <td>1.000</td> <td>PC</td> </tr> <tr> <td>CE1285A0</td> <td>EMI ROUND FERRITE MOD.26438015 02</td> <td>2.000</td> <td>PC</td> </tr> </tbody> </table>	Code	Description	Qty	UOM	CE1097A0	4M SIHF 4 POLES MICROFIT CANBUS	1.000	PC	CE1285A0	EMI ROUND FERRITE MOD.26438015 02	2.000	PC				
					Code	Description	Qty	UOM													
CE1097A0	4M SIHF 4 POLES MICROFIT CANBUS	1.000	PC																		
CE1285A0	EMI ROUND FERRITE MOD.26438015 02	2.000	PC																		
CE1285A	EMI ROUND FERRITE MOD.2643801502		KCE1285A	ROUND FERRITE ELECTROMAGN PROT. 2PCS KIT	<table border="1"> <thead> <tr> <th>Code</th> <th>Description</th> <th>Qty</th> <th>UOM</th> </tr> </thead> <tbody> <tr> <td>CE1285A0</td> <td>EMI ROUND FERRITE MOD.26438015 02</td> <td>2.000</td> <td>PC</td> </tr> </tbody> </table>	Code	Description	Qty	UOM	CE1285A0	EMI ROUND FERRITE MOD.26438015 02	2.000	PC								
Code	Description	Qty	UOM																		
CE1285A0	EMI ROUND FERRITE MOD.26438015 02	2.000	PC																		
VI1074A	4X16 SCREW FOR PLASTIC		VI1074A0	4X16 SCREW FOR PLASTIC																	
MG1099A	MM COMPLETE HANDLE		KMG1099A	MIND.Maps SERIES HANDLE KIT -M	<table border="1"> <thead> <tr> <th>Code</th> <th>Description</th> <th>Qty</th> <th>UOM</th> </tr> </thead> <tbody> <tr> <td>MG1099A1</td> <td>MM COMPLETE HANDLE</td> <td>1.000</td> <td>PC</td> </tr> <tr> <td>VI0239A1</td> <td>SELF-TAPPIN G SCREW 4.2X25 TCB+ INOX</td> <td>4.000</td> <td>PC</td> </tr> <tr> <td>VM1490A0</td> <td>CHEFTOP/BAK ERTOP HANDLE SCREWS COVER</td> <td>2.000</td> <td>PC</td> </tr> </tbody> </table>	Code	Description	Qty	UOM	MG1099A1	MM COMPLETE HANDLE	1.000	PC	VI0239A1	SELF-TAPPIN G SCREW 4.2X25 TCB+ INOX	4.000	PC	VM1490A0	CHEFTOP/BAK ERTOP HANDLE SCREWS COVER	2.000	PC
					Code	Description	Qty	UOM													
					MG1099A1	MM COMPLETE HANDLE	1.000	PC													
VI0239A1	SELF-TAPPIN G SCREW 4.2X25 TCB+ INOX	4.000	PC																		
VM1490A0	CHEFTOP/BAK ERTOP HANDLE SCREWS COVER	2.000	PC																		
CE1052A	MM USB-CONTROL PANEL CONNECTING CABL		KCE1052A	CONTROL BOARD-USB 650 CONN. CABLE KIT	<table border="1"> <thead> <tr> <th>Code</th> <th>Description</th> <th>Qty</th> <th>UOM</th> </tr> </thead> <tbody> <tr> <td>CE1052A1</td> <td>MM USB-CONTRO L PANEL CONNECTING CABLE</td> <td>1.000</td> <td>PC</td> </tr> </tbody> </table>	Code	Description	Qty	UOM	CE1052A1	MM USB-CONTRO L PANEL CONNECTING CABLE	1.000	PC								
Code	Description	Qty	UOM																		
CE1052A1	MM USB-CONTRO L PANEL CONNECTING CABLE	1.000	PC																		



COMPONENT			SPARE PART																														
Code	Description	Image	Code	Description	Kit components																												
CE1053B	MM MICROFIT LED BAR POWER SUPPLY CABLE		KCE1053B	LED BAR EXTENSION CABLE KIT	<table border="1"> <thead> <tr> <th>Code</th> <th>Description</th> <th>Qty</th> <th>UOM</th> </tr> </thead> <tbody> <tr> <td>CE1053B0</td> <td>MM MICROFIT LED BAR POWER SUPPLY CABL</td> <td>1.000</td> <td>PC</td> </tr> </tbody> </table>	Code	Description	Qty	UOM	CE1053B0	MM MICROFIT LED BAR POWER SUPPLY CABL	1.000	PC																				
Code	Description	Qty	UOM																														
CE1053B0	MM MICROFIT LED BAR POWER SUPPLY CABL	1.000	PC																														
LP1019A	6 SERIES L200 LED LIGHT BAR - E415		KLP1019A	L200 E415 LED LIGHT BAR KIT	<table border="1"> <thead> <tr> <th>Code</th> <th>Description</th> <th>Qty</th> <th>UOM</th> </tr> </thead> <tbody> <tr> <td>LP1019A0</td> <td>6 SERIES L200 LED LIGHT BAR - E415</td> <td>1.000</td> <td>PC</td> </tr> </tbody> </table>	Code	Description	Qty	UOM	LP1019A0	6 SERIES L200 LED LIGHT BAR - E415	1.000	PC																				
Code	Description	Qty	UOM																														
LP1019A0	6 SERIES L200 LED LIGHT BAR - E415	1.000	PC																														
LP1025A	L=415 LED LIGHT BAR COVER		KLP1025A	L415 MM NO LED LIGHT HOLDER KIT	<table border="1"> <thead> <tr> <th>Code</th> <th>Description</th> <th>Qty</th> <th>UOM</th> </tr> </thead> <tbody> <tr> <td>LP1025A0</td> <td>L=415 LED LIGHT BAR COVER</td> <td>1.000</td> <td>PC</td> </tr> </tbody> </table>	Code	Description	Qty	UOM	LP1025A0	L=415 LED LIGHT BAR COVER	1.000	PC																				
Code	Description	Qty	UOM																														
LP1025A0	L=415 LED LIGHT BAR COVER	1.000	PC																														
PE1057A	MM PLUS CAPACITIVE CONTROL PANEL		KPE1057A	MM PLUS CAPACITIVE CONTROL BOARD KIT	<table border="1"> <thead> <tr> <th>Code</th> <th>Description</th> <th>Qty</th> <th>UOM</th> </tr> </thead> <tbody> <tr> <td>CE2007A0</td> <td>4PM-MINIFIT 4PF 100mm MICROFIT CABLE</td> <td>1.000</td> <td>PC</td> </tr> <tr> <td>PE1057A2</td> <td>MM PLUS CAPACITIVE CONTROL PANEL</td> <td>1.000</td> <td>PC</td> </tr> <tr> <td>VI1074A0</td> <td>4X16 SCREW FOR PLASTIC</td> <td>2.000</td> <td>PC</td> </tr> <tr> <td>VM2295A1</td> <td>MIND.MAPS TOUCH CONTROL STYLUS</td> <td>1.000</td> <td>PC</td> </tr> <tr> <td>VP1067A0</td> <td>MM CONTROL BOARD RETROFIT SPACER</td> <td>1.000</td> <td>PC</td> </tr> <tr> <td>VP1078A0</td> <td>MM CONTROL BOARD RETROFIT FRAME</td> <td>1.000</td> <td>PC</td> </tr> </tbody> </table>	Code	Description	Qty	UOM	CE2007A0	4PM-MINIFIT 4PF 100mm MICROFIT CABLE	1.000	PC	PE1057A2	MM PLUS CAPACITIVE CONTROL PANEL	1.000	PC	VI1074A0	4X16 SCREW FOR PLASTIC	2.000	PC	VM2295A1	MIND.MAPS TOUCH CONTROL STYLUS	1.000	PC	VP1067A0	MM CONTROL BOARD RETROFIT SPACER	1.000	PC	VP1078A0	MM CONTROL BOARD RETROFIT FRAME	1.000	PC
Code	Description	Qty	UOM																														
CE2007A0	4PM-MINIFIT 4PF 100mm MICROFIT CABLE	1.000	PC																														
PE1057A2	MM PLUS CAPACITIVE CONTROL PANEL	1.000	PC																														
VI1074A0	4X16 SCREW FOR PLASTIC	2.000	PC																														
VM2295A1	MIND.MAPS TOUCH CONTROL STYLUS	1.000	PC																														
VP1067A0	MM CONTROL BOARD RETROFIT SPACER	1.000	PC																														
VP1078A0	MM CONTROL BOARD RETROFIT FRAME	1.000	PC																														

COMPONENT			SPARE PART																										
Code	Description	Image	Code	Description	Kit components																								
PE1059A	MM USB-RESET SUPPORT		KPE1059A	MM USB-RESET SUPPORT KIT	<table border="1"> <thead> <tr> <th>Code</th> <th>Description</th> <th>Qty</th> <th>UOM</th> </tr> </thead> <tbody> <tr> <td>PE1059A0</td> <td>MM USB-RESET SUPPORT</td> <td>1.000</td> <td>PC</td> </tr> <tr> <td>VI1220A1</td> <td>4,2x12 TCB SELF-TAPPING SCREW</td> <td>2.000</td> <td>PC</td> </tr> </tbody> </table>	Code	Description	Qty	UOM	PE1059A0	MM USB-RESET SUPPORT	1.000	PC	VI1220A1	4,2x12 TCB SELF-TAPPING SCREW	2.000	PC												
Code	Description	Qty	UOM																										
PE1059A0	MM USB-RESET SUPPORT	1.000	PC																										
VI1220A1	4,2x12 TCB SELF-TAPPING SCREW	2.000	PC																										
VI1034A	STAINLESS STEEL WASHER 8.4x16x1		KVI1034A	STAINLESS STEEL WASHER 10 PCS KIT	<table border="1"> <thead> <tr> <th>Code</th> <th>Description</th> <th>Qty</th> <th>UOM</th> </tr> </thead> <tbody> <tr> <td>VI1034A0</td> <td>STAINLESS STEEL WASHER 8.4x16x1</td> <td>10.000</td> <td>PC</td> </tr> </tbody> </table>	Code	Description	Qty	UOM	VI1034A0	STAINLESS STEEL WASHER 8.4x16x1	10.000	PC																
Code	Description	Qty	UOM																										
VI1034A0	STAINLESS STEEL WASHER 8.4x16x1	10.000	PC																										
VT1290A	EXTERNAL GLASS XEBC-04EU-E		KVT1290A	04EU EXTERNAL GLASS KIT	<table border="1"> <thead> <tr> <th>Code</th> <th>Description</th> <th>Qty</th> <th>UOM</th> </tr> </thead> <tbody> <tr> <td>0B1166A1</td> <td>XEVC-0511-E EXT GLASS SUPPORT PROFILE</td> <td>2.000</td> <td>PC</td> </tr> <tr> <td>SL1222A0</td> <td>0511 EXTERNAL GLASS LATERAL SILICONE</td> <td>4.000</td> <td>PC</td> </tr> <tr> <td>SL1229A0</td> <td>BAKER EXTERNAL GLASS UPPER SILICONE</td> <td>1.000</td> <td>PC</td> </tr> <tr> <td>VT1290A0</td> <td>EXTERNAL GLASS XEBC-04EU-E</td> <td>1.000</td> <td>PC</td> </tr> </tbody> </table>	Code	Description	Qty	UOM	0B1166A1	XEVC-0511-E EXT GLASS SUPPORT PROFILE	2.000	PC	SL1222A0	0511 EXTERNAL GLASS LATERAL SILICONE	4.000	PC	SL1229A0	BAKER EXTERNAL GLASS UPPER SILICONE	1.000	PC	VT1290A0	EXTERNAL GLASS XEBC-04EU-E	1.000	PC				
Code	Description	Qty	UOM																										
0B1166A1	XEVC-0511-E EXT GLASS SUPPORT PROFILE	2.000	PC																										
SL1222A0	0511 EXTERNAL GLASS LATERAL SILICONE	4.000	PC																										
SL1229A0	BAKER EXTERNAL GLASS UPPER SILICONE	1.000	PC																										
VT1290A0	EXTERNAL GLASS XEBC-04EU-E	1.000	PC																										
			KDR1272B	BT-04 -M EXTERNAL LEFT DOOR	<table border="1"> <thead> <tr> <th>Code</th> <th>Description</th> <th>Qty</th> <th>UOM</th> </tr> </thead> <tbody> <tr> <td>0B1126B0</td> <td>860mm DOOR LOWER BEAM</td> <td>1.000</td> <td>PC</td> </tr> <tr> <td>0B1166A1</td> <td>XEVC-0511-E EXT GLASS SUPPORT PROFILE</td> <td>2.000</td> <td>PC</td> </tr> <tr> <td>0B1195B1</td> <td>LEFT 0511 DOOR LEFT EXT COLUMN</td> <td>1.000</td> <td>PC</td> </tr> <tr> <td>0B1196A1</td> <td>LEFT 0511 DOOR RIGHT INT COLUMN</td> <td>1.000</td> <td>PC</td> </tr> <tr> <td>0B1197A1</td> <td>LEFT 0511 DOOR LEFT INT COLUMN</td> <td>1.000</td> <td>PC</td> </tr> </tbody> </table>	Code	Description	Qty	UOM	0B1126B0	860mm DOOR LOWER BEAM	1.000	PC	0B1166A1	XEVC-0511-E EXT GLASS SUPPORT PROFILE	2.000	PC	0B1195B1	LEFT 0511 DOOR LEFT EXT COLUMN	1.000	PC	0B1196A1	LEFT 0511 DOOR RIGHT INT COLUMN	1.000	PC	0B1197A1	LEFT 0511 DOOR LEFT INT COLUMN	1.000	PC
Code	Description	Qty	UOM																										
0B1126B0	860mm DOOR LOWER BEAM	1.000	PC																										
0B1166A1	XEVC-0511-E EXT GLASS SUPPORT PROFILE	2.000	PC																										
0B1195B1	LEFT 0511 DOOR LEFT EXT COLUMN	1.000	PC																										
0B1196A1	LEFT 0511 DOOR RIGHT INT COLUMN	1.000	PC																										
0B1197A1	LEFT 0511 DOOR LEFT INT COLUMN	1.000	PC																										



COMPONENT			SPARE PART																																																														
Code	Description	Image	Code	Description	Kit components																																																												
VT1290A	EXTERNAL GLASS XEBC-04EU-E		KDR1272B	BT-04 -M EXTERNAL LEFT DOOR	<table border="1"> <thead> <tr> <th>Code</th> <th>Description</th> <th>Qty</th> <th>UOM</th> </tr> </thead> <tbody> <tr> <td>0B1209A0</td> <td>LEFT 04EU DOOR RIGHT EXT COLUMN</td> <td>1.000</td> <td>PC</td> </tr> <tr> <td>0B1218B0</td> <td>860MM DOUBLE GLASS DOOR UPPER BEAM</td> <td>1.000</td> <td>PC</td> </tr> <tr> <td>0B1219A1</td> <td>MM DOUBLE GLASS DOOR INT UPPER BEAM 860</td> <td>1.000</td> <td>PC</td> </tr> <tr> <td>CE1052A1</td> <td>MM USB-CONTRO L PANEL CONNECTING CABLE</td> <td>1.000</td> <td>PC</td> </tr> <tr> <td>CE1053B0</td> <td>MM MICROFIT LED BAR POWER SUPPLY CABL</td> <td>1.000</td> <td>PC</td> </tr> <tr> <td>CE1097A0</td> <td>4M SIHF 4 POLES MICROFIT CANBUS</td> <td>1.000</td> <td>PC</td> </tr> <tr> <td>CE1285A0</td> <td>EMI ROUND FERRITE MOD.26438015 02</td> <td>2.000</td> <td>PC</td> </tr> <tr> <td>LP1019A0</td> <td>6 SERIES L200 LED LIGHT BAR - E415</td> <td>1.000</td> <td>PC</td> </tr> <tr> <td>LP1025A0</td> <td>L=415 LED LIGHT BAR COVER</td> <td>1.000</td> <td>PC</td> </tr> <tr> <td>MG1099A1</td> <td>MM COMPLETE HANDLE</td> <td>1.000</td> <td>PC</td> </tr> <tr> <td>RC1200A0</td> <td>ED=4 WIRE D=0.5 H24 COMPRESSIO N SPRING</td> <td>4.000</td> <td>PC</td> </tr> <tr> <td>SL1170A1</td> <td>S57 BLACK SILICON - 310ml CARTRIDGE</td> <td>35.000</td> <td>ML</td> </tr> <tr> <td>SL1222A0</td> <td>0511 EXTERNAL GLASS LATERAL SILICONE</td> <td>4.000</td> <td>PC</td> </tr> <tr> <td>SL1229A0</td> <td>BAKER EXTERNAL GLASS UPPER SILICONE</td> <td>1.000</td> <td>PC</td> </tr> </tbody> </table>	Code	Description	Qty	UOM	0B1209A0	LEFT 04EU DOOR RIGHT EXT COLUMN	1.000	PC	0B1218B0	860MM DOUBLE GLASS DOOR UPPER BEAM	1.000	PC	0B1219A1	MM DOUBLE GLASS DOOR INT UPPER BEAM 860	1.000	PC	CE1052A1	MM USB-CONTRO L PANEL CONNECTING CABLE	1.000	PC	CE1053B0	MM MICROFIT LED BAR POWER SUPPLY CABL	1.000	PC	CE1097A0	4M SIHF 4 POLES MICROFIT CANBUS	1.000	PC	CE1285A0	EMI ROUND FERRITE MOD.26438015 02	2.000	PC	LP1019A0	6 SERIES L200 LED LIGHT BAR - E415	1.000	PC	LP1025A0	L=415 LED LIGHT BAR COVER	1.000	PC	MG1099A1	MM COMPLETE HANDLE	1.000	PC	RC1200A0	ED=4 WIRE D=0.5 H24 COMPRESSIO N SPRING	4.000	PC	SL1170A1	S57 BLACK SILICON - 310ml CARTRIDGE	35.000	ML	SL1222A0	0511 EXTERNAL GLASS LATERAL SILICONE	4.000	PC	SL1229A0	BAKER EXTERNAL GLASS UPPER SILICONE	1.000	PC
Code	Description	Qty	UOM																																																														
0B1209A0	LEFT 04EU DOOR RIGHT EXT COLUMN	1.000	PC																																																														
0B1218B0	860MM DOUBLE GLASS DOOR UPPER BEAM	1.000	PC																																																														
0B1219A1	MM DOUBLE GLASS DOOR INT UPPER BEAM 860	1.000	PC																																																														
CE1052A1	MM USB-CONTRO L PANEL CONNECTING CABLE	1.000	PC																																																														
CE1053B0	MM MICROFIT LED BAR POWER SUPPLY CABL	1.000	PC																																																														
CE1097A0	4M SIHF 4 POLES MICROFIT CANBUS	1.000	PC																																																														
CE1285A0	EMI ROUND FERRITE MOD.26438015 02	2.000	PC																																																														
LP1019A0	6 SERIES L200 LED LIGHT BAR - E415	1.000	PC																																																														
LP1025A0	L=415 LED LIGHT BAR COVER	1.000	PC																																																														
MG1099A1	MM COMPLETE HANDLE	1.000	PC																																																														
RC1200A0	ED=4 WIRE D=0.5 H24 COMPRESSIO N SPRING	4.000	PC																																																														
SL1170A1	S57 BLACK SILICON - 310ml CARTRIDGE	35.000	ML																																																														
SL1222A0	0511 EXTERNAL GLASS LATERAL SILICONE	4.000	PC																																																														
SL1229A0	BAKER EXTERNAL GLASS UPPER SILICONE	1.000	PC																																																														

COMPONENT			SPARE PART																																																																										
Code	Description	Image	Code	Description	Kit components																																																																								
VT1290A	EXTERNAL GLASS XEBC-04EU-E		KDR1272B	BT-04 -M EXTERNAL LEFT DOOR	<table border="1"> <thead> <tr> <th>Code</th> <th>Description</th> <th>Qty</th> <th>UOM</th> </tr> </thead> <tbody> <tr> <td>VE1030A1</td> <td>MAGNET FOR DOOR MICROSWITC H D=22.9mm</td> <td>1.000</td> <td>PC</td> </tr> <tr> <td>VI0239A1</td> <td>SELF-TAPPIN G SCREW 4.2X25 TCB+ INOX</td> <td>4.000</td> <td>PC</td> </tr> <tr> <td>VI1103A0</td> <td>40X12 TBSP SCREW FOR PLASTIC</td> <td>2.000</td> <td>PC</td> </tr> <tr> <td>VI1220A1</td> <td>4,2x12 TCB SELF-TAPPIN G SCREW</td> <td>26.000</td> <td>PC</td> </tr> <tr> <td>VI1930A1</td> <td>5x20 ST. STEEL CHIP SCREW</td> <td>16.000</td> <td>PC</td> </tr> <tr> <td>VI1996A0</td> <td>M5x35 SCREW</td> <td>13.000</td> <td>PC</td> </tr> <tr> <td>VI2070A0</td> <td>SHEETTRACS TCB+ 40x8 SELF-THREAD SCREW</td> <td>6.000</td> <td>PC</td> </tr> <tr> <td>VM1490A0</td> <td>CHEFTOP/BAK ERTOP HANDLE SCREWS COVER</td> <td>2.000</td> <td>PC</td> </tr> <tr> <td>VM1630A1</td> <td>INTERNAL GLASS PUSHING CAP</td> <td>3.000</td> <td>PC</td> </tr> <tr> <td>VM1631A0</td> <td>PLUS INNER GLASS PUSHING CAP</td> <td>3.000</td> <td>PC</td> </tr> <tr> <td>VM2267A0</td> <td>INTERNAL GLASS LOCKING SYSTEM SLIDER</td> <td>2.000</td> <td>PC</td> </tr> <tr> <td>VM2268A0</td> <td>DOOR MAGNET COVER</td> <td>2.000</td> <td>PC</td> </tr> <tr> <td>VM2269B0</td> <td>INNER GLASS FIXING CAP</td> <td>2.000</td> <td>PC</td> </tr> <tr> <td>VM2274A0</td> <td>GROOVED BUSHING</td> <td>1.000</td> <td>PC</td> </tr> <tr> <td>VM2275A0</td> <td>SMOOTH BUSHING</td> <td>1.000</td> <td>PC</td> </tr> <tr> <td>VM2285B0</td> <td>860 SERIES DRIP PROFILE KIT</td> <td>1.000</td> <td>PC</td> </tr> <tr> <td>VM2305A0</td> <td>MM SERIES DOOR CAP FIXING PAWL</td> <td>14.000</td> <td>PC</td> </tr> </tbody> </table>	Code	Description	Qty	UOM	VE1030A1	MAGNET FOR DOOR MICROSWITC H D=22.9mm	1.000	PC	VI0239A1	SELF-TAPPIN G SCREW 4.2X25 TCB+ INOX	4.000	PC	VI1103A0	40X12 TBSP SCREW FOR PLASTIC	2.000	PC	VI1220A1	4,2x12 TCB SELF-TAPPIN G SCREW	26.000	PC	VI1930A1	5x20 ST. STEEL CHIP SCREW	16.000	PC	VI1996A0	M5x35 SCREW	13.000	PC	VI2070A0	SHEETTRACS TCB+ 40x8 SELF-THREAD SCREW	6.000	PC	VM1490A0	CHEFTOP/BAK ERTOP HANDLE SCREWS COVER	2.000	PC	VM1630A1	INTERNAL GLASS PUSHING CAP	3.000	PC	VM1631A0	PLUS INNER GLASS PUSHING CAP	3.000	PC	VM2267A0	INTERNAL GLASS LOCKING SYSTEM SLIDER	2.000	PC	VM2268A0	DOOR MAGNET COVER	2.000	PC	VM2269B0	INNER GLASS FIXING CAP	2.000	PC	VM2274A0	GROOVED BUSHING	1.000	PC	VM2275A0	SMOOTH BUSHING	1.000	PC	VM2285B0	860 SERIES DRIP PROFILE KIT	1.000	PC	VM2305A0	MM SERIES DOOR CAP FIXING PAWL	14.000	PC
Code	Description	Qty	UOM																																																																										
VE1030A1	MAGNET FOR DOOR MICROSWITC H D=22.9mm	1.000	PC																																																																										
VI0239A1	SELF-TAPPIN G SCREW 4.2X25 TCB+ INOX	4.000	PC																																																																										
VI1103A0	40X12 TBSP SCREW FOR PLASTIC	2.000	PC																																																																										
VI1220A1	4,2x12 TCB SELF-TAPPIN G SCREW	26.000	PC																																																																										
VI1930A1	5x20 ST. STEEL CHIP SCREW	16.000	PC																																																																										
VI1996A0	M5x35 SCREW	13.000	PC																																																																										
VI2070A0	SHEETTRACS TCB+ 40x8 SELF-THREAD SCREW	6.000	PC																																																																										
VM1490A0	CHEFTOP/BAK ERTOP HANDLE SCREWS COVER	2.000	PC																																																																										
VM1630A1	INTERNAL GLASS PUSHING CAP	3.000	PC																																																																										
VM1631A0	PLUS INNER GLASS PUSHING CAP	3.000	PC																																																																										
VM2267A0	INTERNAL GLASS LOCKING SYSTEM SLIDER	2.000	PC																																																																										
VM2268A0	DOOR MAGNET COVER	2.000	PC																																																																										
VM2269B0	INNER GLASS FIXING CAP	2.000	PC																																																																										
VM2274A0	GROOVED BUSHING	1.000	PC																																																																										
VM2275A0	SMOOTH BUSHING	1.000	PC																																																																										
VM2285B0	860 SERIES DRIP PROFILE KIT	1.000	PC																																																																										
VM2305A0	MM SERIES DOOR CAP FIXING PAWL	14.000	PC																																																																										



COMPONENT			SPARE PART																																																																													
Code	Description	Image	Code	Description	Kit components																																																																											
VT1290A	EXTERNAL GLASS XEBC-04EU-E		KDR1272B	BT-04 -M EXTERNAL LEFT DOOR	<table border="1"> <thead> <tr> <th>Code</th> <th>Description</th> <th>Qty</th> <th>UOM</th> </tr> </thead> <tbody> <tr> <td>VM2313A0</td> <td>MM DRIP TRAY RIGHT DRAIN PIPE</td> <td>1.000</td> <td>PC</td> </tr> <tr> <td>VM2314A0</td> <td>MM DRIP PROFILE CAP</td> <td>1.000</td> <td>PC</td> </tr> <tr> <td>VM2315B0</td> <td>S6 INTERNAL GLASS SUPPORT</td> <td>3.000</td> <td>PC</td> </tr> <tr> <td>VM2383B0</td> <td>MM LEFT DOOR UPPER RIGHT CAP</td> <td>1.000</td> <td>PC</td> </tr> <tr> <td>VM2384B0</td> <td>MM LEFT DOOR RIGHT LOWER CAP</td> <td>1.000</td> <td>PC</td> </tr> <tr> <td>VM2385B0</td> <td>MM LEFT DOOR UPPER LEFT CAP</td> <td>1.000</td> <td>PC</td> </tr> <tr> <td>VM2386B0</td> <td>MM -M LEFT DOOR LEFT LOWER CAP KI</td> <td>1.000</td> <td>PC</td> </tr> <tr> <td>VM2505B1</td> <td>MM PLUS INTERNAL GLASS SUPPORT</td> <td>3.000</td> <td>PC</td> </tr> <tr> <td>VP1080A0</td> <td>UPPER HINGE CAP FOR LOWER INNER GLASS</td> <td>1.000</td> <td>PC</td> </tr> <tr> <td>VP1081A0</td> <td>UPPER HINGE CAP FOR UPPER INNER GLASS</td> <td>1.000</td> <td>PC</td> </tr> <tr> <td>VT1290A0</td> <td>EXTERNAL GLASS XEBC-04EU-E</td> <td>1.000</td> <td>PC</td> </tr> </tbody> </table>	Code	Description	Qty	UOM	VM2313A0	MM DRIP TRAY RIGHT DRAIN PIPE	1.000	PC	VM2314A0	MM DRIP PROFILE CAP	1.000	PC	VM2315B0	S6 INTERNAL GLASS SUPPORT	3.000	PC	VM2383B0	MM LEFT DOOR UPPER RIGHT CAP	1.000	PC	VM2384B0	MM LEFT DOOR RIGHT LOWER CAP	1.000	PC	VM2385B0	MM LEFT DOOR UPPER LEFT CAP	1.000	PC	VM2386B0	MM -M LEFT DOOR LEFT LOWER CAP KI	1.000	PC	VM2505B1	MM PLUS INTERNAL GLASS SUPPORT	3.000	PC	VP1080A0	UPPER HINGE CAP FOR LOWER INNER GLASS	1.000	PC	VP1081A0	UPPER HINGE CAP FOR UPPER INNER GLASS	1.000	PC	VT1290A0	EXTERNAL GLASS XEBC-04EU-E	1.000	PC	KDR1272A	BT-04 EXTERNAL LEFT DOOR	<table border="1"> <thead> <tr> <th>Code</th> <th>Description</th> <th>Qty</th> <th>UOM</th> </tr> </thead> <tbody> <tr> <td>0B1126A1</td> <td>860mm DOOR LOWER FRAME SHAPE</td> <td>1.000</td> <td>PC</td> </tr> <tr> <td>0B1166A1</td> <td>XEVC-0511-E EXT GLASS SUPPORT PROFILE</td> <td>2.000</td> <td>PC</td> </tr> <tr> <td>0B1195B1</td> <td>LEFT 0511 DOOR LEFT EXT COLUMN</td> <td>1.000</td> <td>PC</td> </tr> <tr> <td>0B1196A1</td> <td>LEFT 0511 DOOR RIGHT INT COLUMN</td> <td>1.000</td> <td>PC</td> </tr> <tr> <td>0B1197A1</td> <td>LEFT 0511 DOOR LEFT INT COLUMN</td> <td>1.000</td> <td>PC</td> </tr> </tbody> </table>	Code	Description	Qty	UOM	0B1126A1	860mm DOOR LOWER FRAME SHAPE	1.000	PC	0B1166A1	XEVC-0511-E EXT GLASS SUPPORT PROFILE	2.000	PC	0B1195B1	LEFT 0511 DOOR LEFT EXT COLUMN	1.000	PC	0B1196A1	LEFT 0511 DOOR RIGHT INT COLUMN	1.000	PC	0B1197A1	LEFT 0511 DOOR LEFT INT COLUMN	1.000	PC
			Code	Description	Qty	UOM																																																																										
VM2313A0	MM DRIP TRAY RIGHT DRAIN PIPE	1.000	PC																																																																													
VM2314A0	MM DRIP PROFILE CAP	1.000	PC																																																																													
VM2315B0	S6 INTERNAL GLASS SUPPORT	3.000	PC																																																																													
VM2383B0	MM LEFT DOOR UPPER RIGHT CAP	1.000	PC																																																																													
VM2384B0	MM LEFT DOOR RIGHT LOWER CAP	1.000	PC																																																																													
VM2385B0	MM LEFT DOOR UPPER LEFT CAP	1.000	PC																																																																													
VM2386B0	MM -M LEFT DOOR LEFT LOWER CAP KI	1.000	PC																																																																													
VM2505B1	MM PLUS INTERNAL GLASS SUPPORT	3.000	PC																																																																													
VP1080A0	UPPER HINGE CAP FOR LOWER INNER GLASS	1.000	PC																																																																													
VP1081A0	UPPER HINGE CAP FOR UPPER INNER GLASS	1.000	PC																																																																													
VT1290A0	EXTERNAL GLASS XEBC-04EU-E	1.000	PC																																																																													
Code	Description	Qty	UOM																																																																													
0B1126A1	860mm DOOR LOWER FRAME SHAPE	1.000	PC																																																																													
0B1166A1	XEVC-0511-E EXT GLASS SUPPORT PROFILE	2.000	PC																																																																													
0B1195B1	LEFT 0511 DOOR LEFT EXT COLUMN	1.000	PC																																																																													
0B1196A1	LEFT 0511 DOOR RIGHT INT COLUMN	1.000	PC																																																																													
0B1197A1	LEFT 0511 DOOR LEFT INT COLUMN	1.000	PC																																																																													



COMPONENT			SPARE PART					
Code	Description	Image	Code	Description	Kit components			
VT1290A	EXTERNAL GLASS XEBC-04EU-E		KDR1272A	BT-04 EXTERNAL LEFT DOOR	Code	Description	Qty	UOM
					0B1209A0	LEFT 04EU DOOR RIGHT EXT COLUMN	1.000	PC
					0B1218A1	860MM DOUBLE GLASS DOOR UPPER BEAM	1.000	PC
					0B1219A1	MM DOUBLE GLASS DOOR INT UPPER BEAM 860	1.000	PC
					CE1052A1	MM USB-CONTRO L PANEL CONNECTING CABLE	1.000	PC
					CE1053B0	MM MICROFIT LED BAR POWER SUPPLY CABL	1.000	PC
					CE1285A0	EMI ROUND FERRITE MOD.26438015 02	1.000	PC
					CE1290A0	EXTRACTABL E FEMALE TERMINAL CPF 5/4	1.000	PC
					CE1310A1	POWER - CONTROL BOARD CONNECTING CABLE	1.000	PC
					LP1019A0	6 SERIES L200 LED LIGHT BAR - E415	1.000	PC
					LP1025A0	L=415 LED LIGHT BAR COVER	1.000	PC
					MG1083A2	MM COMPLETE HANDLE	1.000	PC
					SL1170A1	S57 BLACK SILICON - 310ml CARTRIDGE	30.000	ML
					VE1030A1	MAGNET FOR DOOR MICROSWITC H D=22.9mm	1.000	PC
					VI1147A0	5X25 STAINLESS STEEL SCREW	16.000	PC



COMPONENT			SPARE PART																																																																															
Code	Description	Image	Code	Description	Kit components																																																																													
VT1290A	EXTERNAL GLASS XEBC-04EU-E		KDR1272A	BT-04 EXTERNAL LEFT DOOR	<table border="1"> <thead> <tr> <th>Code</th> <th>Description</th> <th>Qty</th> <th>UOM</th> </tr> </thead> <tbody> <tr> <td>VI1220A1</td> <td>4,2x12 TCB SELF-TAPPIN G SCREW</td> <td>25.000</td> <td>PC</td> </tr> <tr> <td>VI1996A0</td> <td>M5x35 SCREW</td> <td>13.000</td> <td>PC</td> </tr> <tr> <td>VM1630A1</td> <td>INTERNAL GLASS PUSHING CAP</td> <td>3.000</td> <td>PC</td> </tr> <tr> <td>VM1631A0</td> <td>PLUS INNER GLASS PUSHING CAP</td> <td>2.000</td> <td>PC</td> </tr> <tr> <td>VM2267A0</td> <td>INTERNAL GLASS LOCKING SYSTEM SLIDER</td> <td>2.000</td> <td>PC</td> </tr> <tr> <td>VM2268A0</td> <td>DOOR MAGNET COVER</td> <td>2.000</td> <td>PC</td> </tr> <tr> <td>VM2269A0</td> <td>INTERNAL GLASS LOCKING SYSTEM CAP</td> <td>2.000</td> <td>PC</td> </tr> <tr> <td>VM2274A0</td> <td>GROOVED BUSHING</td> <td>1.000</td> <td>PC</td> </tr> <tr> <td>VM2275A0</td> <td>SMOOTH BUSHING</td> <td>1.000</td> <td>PC</td> </tr> <tr> <td>VM2285A0</td> <td>860 SERIES DRIP PROFILE</td> <td>1.000</td> <td>PC</td> </tr> <tr> <td>VM2305A0</td> <td>MM SERIES DOOR CAP FIXING PAWL</td> <td>14.000</td> <td>PC</td> </tr> <tr> <td>VM2312A0</td> <td>MM DRIP PROFILE DRAIN LEFT PIPE</td> <td>1.000</td> <td>PC</td> </tr> <tr> <td>VM2313A0</td> <td>MM DRIP TRAY RIGHT DRAIN PIPE</td> <td>1.000</td> <td>PC</td> </tr> <tr> <td>VM2314A0</td> <td>MM DRIP PROFILE CAP</td> <td>1.000</td> <td>PC</td> </tr> <tr> <td>VM2315A0</td> <td>MIND.Maps INTERNAL GLASS CAP SUPPORT</td> <td>3.000</td> <td>PC</td> </tr> <tr> <td>VM2383A0</td> <td>MM LEFT DOOR RIGHT UPPER CAP</td> <td>1.000</td> <td>PC</td> </tr> <tr> <td>VM2384A0</td> <td>MM LEFT DOOR RIGHT LOWER CAP</td> <td>1.000</td> <td>PC</td> </tr> <tr> <td>VM2385A1</td> <td>LEFT MM DOOR UPPER LEFT CAP</td> <td>1.000</td> <td>PC</td> </tr> </tbody> </table>	Code	Description	Qty	UOM	VI1220A1	4,2x12 TCB SELF-TAPPIN G SCREW	25.000	PC	VI1996A0	M5x35 SCREW	13.000	PC	VM1630A1	INTERNAL GLASS PUSHING CAP	3.000	PC	VM1631A0	PLUS INNER GLASS PUSHING CAP	2.000	PC	VM2267A0	INTERNAL GLASS LOCKING SYSTEM SLIDER	2.000	PC	VM2268A0	DOOR MAGNET COVER	2.000	PC	VM2269A0	INTERNAL GLASS LOCKING SYSTEM CAP	2.000	PC	VM2274A0	GROOVED BUSHING	1.000	PC	VM2275A0	SMOOTH BUSHING	1.000	PC	VM2285A0	860 SERIES DRIP PROFILE	1.000	PC	VM2305A0	MM SERIES DOOR CAP FIXING PAWL	14.000	PC	VM2312A0	MM DRIP PROFILE DRAIN LEFT PIPE	1.000	PC	VM2313A0	MM DRIP TRAY RIGHT DRAIN PIPE	1.000	PC	VM2314A0	MM DRIP PROFILE CAP	1.000	PC	VM2315A0	MIND.Maps INTERNAL GLASS CAP SUPPORT	3.000	PC	VM2383A0	MM LEFT DOOR RIGHT UPPER CAP	1.000	PC	VM2384A0	MM LEFT DOOR RIGHT LOWER CAP	1.000	PC	VM2385A1	LEFT MM DOOR UPPER LEFT CAP	1.000	PC	
Code	Description	Qty	UOM																																																																															
VI1220A1	4,2x12 TCB SELF-TAPPIN G SCREW	25.000	PC																																																																															
VI1996A0	M5x35 SCREW	13.000	PC																																																																															
VM1630A1	INTERNAL GLASS PUSHING CAP	3.000	PC																																																																															
VM1631A0	PLUS INNER GLASS PUSHING CAP	2.000	PC																																																																															
VM2267A0	INTERNAL GLASS LOCKING SYSTEM SLIDER	2.000	PC																																																																															
VM2268A0	DOOR MAGNET COVER	2.000	PC																																																																															
VM2269A0	INTERNAL GLASS LOCKING SYSTEM CAP	2.000	PC																																																																															
VM2274A0	GROOVED BUSHING	1.000	PC																																																																															
VM2275A0	SMOOTH BUSHING	1.000	PC																																																																															
VM2285A0	860 SERIES DRIP PROFILE	1.000	PC																																																																															
VM2305A0	MM SERIES DOOR CAP FIXING PAWL	14.000	PC																																																																															
VM2312A0	MM DRIP PROFILE DRAIN LEFT PIPE	1.000	PC																																																																															
VM2313A0	MM DRIP TRAY RIGHT DRAIN PIPE	1.000	PC																																																																															
VM2314A0	MM DRIP PROFILE CAP	1.000	PC																																																																															
VM2315A0	MIND.Maps INTERNAL GLASS CAP SUPPORT	3.000	PC																																																																															
VM2383A0	MM LEFT DOOR RIGHT UPPER CAP	1.000	PC																																																																															
VM2384A0	MM LEFT DOOR RIGHT LOWER CAP	1.000	PC																																																																															
VM2385A1	LEFT MM DOOR UPPER LEFT CAP	1.000	PC																																																																															



COMPONENT			SPARE PART																																							
Code	Description	Image	Code	Description	Kit components																																					
VT1290A	EXTERNAL GLASS XEBC-04EU-E		KDR1272A	BT-04 EXTERNAL LEFT DOOR	<table border="1"> <thead> <tr> <th>Code</th> <th>Description</th> <th>Qty</th> <th>UOM</th> </tr> </thead> <tbody> <tr> <td>VM2386A1</td> <td>LEFT MM DOOR LOWER LEFT CAP</td> <td>1.000</td> <td>PC</td> </tr> <tr> <td>VM2505A0</td> <td>MM PLUS INTERNAL GLASS SUPPORT</td> <td>2.000</td> <td>PC</td> </tr> <tr> <td>VM2518A0</td> <td>BOARD COOLING FAN SUPPORT</td> <td>1.000</td> <td>PC</td> </tr> <tr> <td>VN1179A1</td> <td>CONTROL BOARD 40x40x20mm 12V COOLING FAN</td> <td>1.000</td> <td>PC</td> </tr> <tr> <td>VT1290A0</td> <td>EXTERNAL GLASS XEBC-04EU-E</td> <td>1.000</td> <td>PC</td> </tr> </tbody> </table>	Code	Description	Qty	UOM	VM2386A1	LEFT MM DOOR LOWER LEFT CAP	1.000	PC	VM2505A0	MM PLUS INTERNAL GLASS SUPPORT	2.000	PC	VM2518A0	BOARD COOLING FAN SUPPORT	1.000	PC	VN1179A1	CONTROL BOARD 40x40x20mm 12V COOLING FAN	1.000	PC	VT1290A0	EXTERNAL GLASS XEBC-04EU-E	1.000	PC													
			Code	Description	Qty	UOM																																				
VM2386A1	LEFT MM DOOR LOWER LEFT CAP	1.000	PC																																							
VM2505A0	MM PLUS INTERNAL GLASS SUPPORT	2.000	PC																																							
VM2518A0	BOARD COOLING FAN SUPPORT	1.000	PC																																							
VN1179A1	CONTROL BOARD 40x40x20mm 12V COOLING FAN	1.000	PC																																							
VT1290A0	EXTERNAL GLASS XEBC-04EU-E	1.000	PC																																							
KDR1269B	BT-04 -M EXTERNAL RIGHT DOOR	<table border="1"> <thead> <tr> <th>Code</th> <th>Description</th> <th>Qty</th> <th>UOM</th> </tr> </thead> <tbody> <tr> <td>0B1107A1</td> <td>XEVC-0511-E LEFT INT DOOR COLUM</td> <td>1.000</td> <td>PC</td> </tr> <tr> <td>0B1108B1</td> <td>XEVC-0511 DOOR EXTERNAL RIGHT COLUM</td> <td>1.000</td> <td>PC</td> </tr> <tr> <td>0B1109A1</td> <td>XEVC-0511-E RIGHT INT DOOR COLUM</td> <td>1.000</td> <td>PC</td> </tr> <tr> <td>0B1126B0</td> <td>860mm DOOR LOWER BEAM</td> <td>1.000</td> <td>PC</td> </tr> <tr> <td>0B1166A1</td> <td>XEVC-0511-E EXT GLASS SUPPORT PROFILE</td> <td>2.000</td> <td>PC</td> </tr> <tr> <td>0B1174A0</td> <td>XEBC-04EU-E LEFT EXT DOOR COLUM</td> <td>1.000</td> <td>PC</td> </tr> <tr> <td>0B1218B0</td> <td>860MM DOUBLE GLASS DOOR UPPER BEAM</td> <td>1.000</td> <td>PC</td> </tr> <tr> <td>0B1219A1</td> <td>MM DOUBLE GLASS DOOR INT UPPER BEAM 860</td> <td>1.000</td> <td>PC</td> </tr> <tr> <td>CE1052A1</td> <td>MM USB-CONTRO L PANEL CONNECTING CABLE</td> <td>1.000</td> <td>PC</td> </tr> </tbody> </table>	Code	Description	Qty	UOM	0B1107A1	XEVC-0511-E LEFT INT DOOR COLUM	1.000	PC	0B1108B1	XEVC-0511 DOOR EXTERNAL RIGHT COLUM	1.000	PC	0B1109A1	XEVC-0511-E RIGHT INT DOOR COLUM	1.000	PC	0B1126B0	860mm DOOR LOWER BEAM	1.000	PC	0B1166A1	XEVC-0511-E EXT GLASS SUPPORT PROFILE	2.000	PC	0B1174A0	XEBC-04EU-E LEFT EXT DOOR COLUM	1.000	PC	0B1218B0	860MM DOUBLE GLASS DOOR UPPER BEAM	1.000	PC	0B1219A1	MM DOUBLE GLASS DOOR INT UPPER BEAM 860	1.000	PC	CE1052A1	MM USB-CONTRO L PANEL CONNECTING CABLE	1.000	PC
Code	Description	Qty	UOM																																							
0B1107A1	XEVC-0511-E LEFT INT DOOR COLUM	1.000	PC																																							
0B1108B1	XEVC-0511 DOOR EXTERNAL RIGHT COLUM	1.000	PC																																							
0B1109A1	XEVC-0511-E RIGHT INT DOOR COLUM	1.000	PC																																							
0B1126B0	860mm DOOR LOWER BEAM	1.000	PC																																							
0B1166A1	XEVC-0511-E EXT GLASS SUPPORT PROFILE	2.000	PC																																							
0B1174A0	XEBC-04EU-E LEFT EXT DOOR COLUM	1.000	PC																																							
0B1218B0	860MM DOUBLE GLASS DOOR UPPER BEAM	1.000	PC																																							
0B1219A1	MM DOUBLE GLASS DOOR INT UPPER BEAM 860	1.000	PC																																							
CE1052A1	MM USB-CONTRO L PANEL CONNECTING CABLE	1.000	PC																																							



COMPONENT			SPARE PART					
Code	Description	Image	Code	Description	Kit components			
VT1290A	EXTERNAL GLASS XEBC-04EU-E		KDR1269B	BT-04 -M EXTERNAL RIGHT DOOR	Code	Description	Qty	UOM
					CE1053B0	MM MICROFIT LED BAR POWER SUPPLY CABL	1.000	PC
					CE1097A0	4M SIHF 4 POLES MICROFIT CANBUS	1.000	PC
					CE1285A0	EMI ROUND FERRITE MOD.26438015 02	2.000	PC
					LP1019A0	6 SERIES L200 LED LIGHT BAR - E415	1.000	PC
					LP1025A0	L=415 LED LIGHT BAR COVER	1.000	PC
					MG1099A1	MM COMPLETE HANDLE	1.000	PC
					RC1200A0	ED=4 WIRE D=0.5 H24 COMPRESSIO N SPRING	4.000	PC
					SL1170A1	S57 BLACK SILICON - 310ml CARTRIDGE	35.000	ML
					SL1222A0	0511 EXTERNAL GLASS LATERAL SILICONE	4.000	PC
					SL1229A0	BAKER EXTERNAL GLASS UPPER SILICONE	1.000	PC
					VE1030A1	MAGNET FOR DOOR MICROSWITC H D=22.9mm	1.000	PC
					VI0239A1	SELF-TAPPIN G SCREW 4.2X25 TCB+ INOX	4.000	PC
					VI1074A0	4X16 SCREW FOR PLASTIC	2.000	PC
					VI1103A0	40X12 TBSP SCREW FOR PLASTIC	4.000	PC
VI1220A1	4,2x12 TCB SELF-TAPPIN G SCREW	28.000	PC					



COMPONENT			SPARE PART																																																																																		
Code	Description	Image	Code	Description	Kit components																																																																																
VT1290A	EXTERNAL GLASS XEBC-04EU-E		KDR1269B	BT-04 -M EXTERNAL RIGHT DOOR	<table border="1"> <thead> <tr> <th>Code</th> <th>Description</th> <th>Qty</th> <th>UOM</th> </tr> </thead> <tbody> <tr> <td>VI1930A1</td> <td>5x20 ST. STEEL CHIP SCREW</td> <td>16.000</td> <td>PC</td> </tr> <tr> <td>VI1996A0</td> <td>M5x35 SCREW</td> <td>13.000</td> <td>PC</td> </tr> <tr> <td>VI2070A0</td> <td>SHEETTRACS TCB+ 40x8 SELF-THREAD SCREW</td> <td>6.000</td> <td>PC</td> </tr> <tr> <td>VM1490A0</td> <td>CHEFTOP/BAK ERTOP HANDLE SCREWS COVER</td> <td>2.000</td> <td>PC</td> </tr> <tr> <td>VM1630A1</td> <td>INTERNAL GLASS PUSHING CAP</td> <td>3.000</td> <td>PC</td> </tr> <tr> <td>VM1631A0</td> <td>PLUS INNER GLASS PUSHING CAP</td> <td>3.000</td> <td>PC</td> </tr> <tr> <td>VM2259B0</td> <td>VM2259B0</td> <td>1.000</td> <td>PC</td> </tr> <tr> <td>VM2260B0</td> <td>S6 LEFT UPPER CAP</td> <td>1.000</td> <td>PC</td> </tr> <tr> <td>VM2261B0</td> <td>MM -M DOOR RIGHT LOWER CAP</td> <td>1.000</td> <td>PC</td> </tr> <tr> <td>VM2262B0</td> <td>MM -M DOOR RIGHT UPPER CAP</td> <td>1.000</td> <td>PC</td> </tr> <tr> <td>VM2267A0</td> <td>INTERNAL GLASS LOCKING SYSTEM SLIDER</td> <td>2.000</td> <td>PC</td> </tr> <tr> <td>VM2268A0</td> <td>DOOR MAGNET COVER</td> <td>2.000</td> <td>PC</td> </tr> <tr> <td>VM2269B0</td> <td>INNER GLASS FIXING CAP</td> <td>2.000</td> <td>PC</td> </tr> <tr> <td>VM2274A0</td> <td>GROOVED BUSHING</td> <td>1.000</td> <td>PC</td> </tr> <tr> <td>VM2275A0</td> <td>SMOOTH BUSHING</td> <td>1.000</td> <td>PC</td> </tr> <tr> <td>VM2285B0</td> <td>860 SERIES DRIP PROFILE KIT</td> <td>1.000</td> <td>PC</td> </tr> <tr> <td>VM2305A0</td> <td>MM SERIES DOOR CAP FIXING PAWL</td> <td>14.000</td> <td>PC</td> </tr> <tr> <td>VM2312A0</td> <td>MM DRIP PROFILE DRAIN LEFT PIPE</td> <td>1.000</td> <td>PC</td> </tr> <tr> <td>VM2314A0</td> <td>MM DRIP PROFILE CAP</td> <td>1.000</td> <td>PC</td> </tr> </tbody> </table>	Code	Description	Qty	UOM	VI1930A1	5x20 ST. STEEL CHIP SCREW	16.000	PC	VI1996A0	M5x35 SCREW	13.000	PC	VI2070A0	SHEETTRACS TCB+ 40x8 SELF-THREAD SCREW	6.000	PC	VM1490A0	CHEFTOP/BAK ERTOP HANDLE SCREWS COVER	2.000	PC	VM1630A1	INTERNAL GLASS PUSHING CAP	3.000	PC	VM1631A0	PLUS INNER GLASS PUSHING CAP	3.000	PC	VM2259B0	VM2259B0	1.000	PC	VM2260B0	S6 LEFT UPPER CAP	1.000	PC	VM2261B0	MM -M DOOR RIGHT LOWER CAP	1.000	PC	VM2262B0	MM -M DOOR RIGHT UPPER CAP	1.000	PC	VM2267A0	INTERNAL GLASS LOCKING SYSTEM SLIDER	2.000	PC	VM2268A0	DOOR MAGNET COVER	2.000	PC	VM2269B0	INNER GLASS FIXING CAP	2.000	PC	VM2274A0	GROOVED BUSHING	1.000	PC	VM2275A0	SMOOTH BUSHING	1.000	PC	VM2285B0	860 SERIES DRIP PROFILE KIT	1.000	PC	VM2305A0	MM SERIES DOOR CAP FIXING PAWL	14.000	PC	VM2312A0	MM DRIP PROFILE DRAIN LEFT PIPE	1.000	PC	VM2314A0	MM DRIP PROFILE CAP	1.000	PC
					Code	Description	Qty	UOM																																																																													
					VI1930A1	5x20 ST. STEEL CHIP SCREW	16.000	PC																																																																													
					VI1996A0	M5x35 SCREW	13.000	PC																																																																													
					VI2070A0	SHEETTRACS TCB+ 40x8 SELF-THREAD SCREW	6.000	PC																																																																													
					VM1490A0	CHEFTOP/BAK ERTOP HANDLE SCREWS COVER	2.000	PC																																																																													
					VM1630A1	INTERNAL GLASS PUSHING CAP	3.000	PC																																																																													
					VM1631A0	PLUS INNER GLASS PUSHING CAP	3.000	PC																																																																													
					VM2259B0	VM2259B0	1.000	PC																																																																													
					VM2260B0	S6 LEFT UPPER CAP	1.000	PC																																																																													
					VM2261B0	MM -M DOOR RIGHT LOWER CAP	1.000	PC																																																																													
					VM2262B0	MM -M DOOR RIGHT UPPER CAP	1.000	PC																																																																													
					VM2267A0	INTERNAL GLASS LOCKING SYSTEM SLIDER	2.000	PC																																																																													
					VM2268A0	DOOR MAGNET COVER	2.000	PC																																																																													
					VM2269B0	INNER GLASS FIXING CAP	2.000	PC																																																																													
					VM2274A0	GROOVED BUSHING	1.000	PC																																																																													
					VM2275A0	SMOOTH BUSHING	1.000	PC																																																																													
					VM2285B0	860 SERIES DRIP PROFILE KIT	1.000	PC																																																																													
					VM2305A0	MM SERIES DOOR CAP FIXING PAWL	14.000	PC																																																																													
					VM2312A0	MM DRIP PROFILE DRAIN LEFT PIPE	1.000	PC																																																																													
VM2314A0	MM DRIP PROFILE CAP	1.000	PC																																																																																		



COMPONENT			SPARE PART																																		
Code	Description	Image	Code	Description	Kit components																																
VT1290A	EXTERNAL GLASS XEBC-04EU-E		KDR1269B	BT-04 -M EXTERNAL RIGHT DOOR	<table border="1"> <thead> <tr> <th>Code</th> <th>Description</th> <th>Qty</th> <th>UOM</th> </tr> </thead> <tbody> <tr> <td>VM2315B0</td> <td>S6 INTERNAL GLASS SUPPORT</td> <td>3.000</td> <td>PC</td> </tr> <tr> <td>VM2505B1</td> <td>MM PLUS INTERNAL GLASS SUPPORT</td> <td>3.000</td> <td>PC</td> </tr> <tr> <td>VM2518A0</td> <td>BOARD COOLING FAN SUPPORT</td> <td>1.000</td> <td>PC</td> </tr> <tr> <td>VN1179A1</td> <td>CONTROL BOARD 40x40x20mm 12V COOLING FAN</td> <td>1.000</td> <td>PC</td> </tr> <tr> <td>VP1080A0</td> <td>UPPER HINGE CAP FOR LOWER INNER GLASS</td> <td>1.000</td> <td>PC</td> </tr> <tr> <td>VP1081A0</td> <td>UPPER HINGE CAP FOR UPPER INNER GLASS</td> <td>1.000</td> <td>PC</td> </tr> <tr> <td>VT1290A0</td> <td>EXTERNAL GLASS XEBC-04EU-E</td> <td>1.000</td> <td>PC</td> </tr> </tbody> </table>	Code	Description	Qty	UOM	VM2315B0	S6 INTERNAL GLASS SUPPORT	3.000	PC	VM2505B1	MM PLUS INTERNAL GLASS SUPPORT	3.000	PC	VM2518A0	BOARD COOLING FAN SUPPORT	1.000	PC	VN1179A1	CONTROL BOARD 40x40x20mm 12V COOLING FAN	1.000	PC	VP1080A0	UPPER HINGE CAP FOR LOWER INNER GLASS	1.000	PC	VP1081A0	UPPER HINGE CAP FOR UPPER INNER GLASS	1.000	PC	VT1290A0	EXTERNAL GLASS XEBC-04EU-E	1.000	PC
			Code	Description	Qty	UOM																															
VM2315B0	S6 INTERNAL GLASS SUPPORT	3.000	PC																																		
VM2505B1	MM PLUS INTERNAL GLASS SUPPORT	3.000	PC																																		
VM2518A0	BOARD COOLING FAN SUPPORT	1.000	PC																																		
VN1179A1	CONTROL BOARD 40x40x20mm 12V COOLING FAN	1.000	PC																																		
VP1080A0	UPPER HINGE CAP FOR LOWER INNER GLASS	1.000	PC																																		
VP1081A0	UPPER HINGE CAP FOR UPPER INNER GLASS	1.000	PC																																		
VT1290A0	EXTERNAL GLASS XEBC-04EU-E	1.000	PC																																		
KDR1269A	BT-04 EXTERNAL RIGHT DOOR	<table border="1"> <thead> <tr> <th>Code</th> <th>Description</th> <th>Qty</th> <th>UOM</th> </tr> </thead> <tbody> <tr> <td>0B1107A1</td> <td>XEVC-0511-E LEFT INT DOOR COLUM</td> <td>1.000</td> <td>PC</td> </tr> <tr> <td>0B1108B1</td> <td>XEVC-0511 DOOR EXTERNAL RIGHT COLUM</td> <td>1.000</td> <td>PC</td> </tr> <tr> <td>0B1109A1</td> <td>XEVC-0511-E RIGHT INT DOOR COLUM</td> <td>1.000</td> <td>PC</td> </tr> <tr> <td>0B1126A1</td> <td>860mm DOOR LOWER FRAME SHAPE</td> <td>1.000</td> <td>PC</td> </tr> <tr> <td>0B1166A1</td> <td>XEVC-0511-E EXT GLASS SUPPORT PROFILE</td> <td>2.000</td> <td>PC</td> </tr> <tr> <td>0B1174A0</td> <td>XEBC-04EU-E LEFT EXT DOOR COLUM</td> <td>1.000</td> <td>PC</td> </tr> <tr> <td>0B1218A1</td> <td>860MM DOUBLE GLASS DOOR UPPER BEAM</td> <td>1.000</td> <td>PC</td> </tr> </tbody> </table>	Code	Description	Qty	UOM	0B1107A1	XEVC-0511-E LEFT INT DOOR COLUM	1.000	PC	0B1108B1	XEVC-0511 DOOR EXTERNAL RIGHT COLUM	1.000	PC	0B1109A1	XEVC-0511-E RIGHT INT DOOR COLUM	1.000	PC	0B1126A1	860mm DOOR LOWER FRAME SHAPE	1.000	PC	0B1166A1	XEVC-0511-E EXT GLASS SUPPORT PROFILE	2.000	PC	0B1174A0	XEBC-04EU-E LEFT EXT DOOR COLUM	1.000	PC	0B1218A1	860MM DOUBLE GLASS DOOR UPPER BEAM	1.000	PC			
Code	Description	Qty	UOM																																		
0B1107A1	XEVC-0511-E LEFT INT DOOR COLUM	1.000	PC																																		
0B1108B1	XEVC-0511 DOOR EXTERNAL RIGHT COLUM	1.000	PC																																		
0B1109A1	XEVC-0511-E RIGHT INT DOOR COLUM	1.000	PC																																		
0B1126A1	860mm DOOR LOWER FRAME SHAPE	1.000	PC																																		
0B1166A1	XEVC-0511-E EXT GLASS SUPPORT PROFILE	2.000	PC																																		
0B1174A0	XEBC-04EU-E LEFT EXT DOOR COLUM	1.000	PC																																		
0B1218A1	860MM DOUBLE GLASS DOOR UPPER BEAM	1.000	PC																																		



COMPONENT			SPARE PART																																																																		
Code	Description	Image	Code	Description	Kit components																																																																
VT1290A	EXTERNAL GLASS XEBC-04EU-E		KDR1269A	BT-04 EXTERNAL RIGHT DOOR	<table border="1"> <thead> <tr> <th>Code</th> <th>Description</th> <th>Qty</th> <th>UOM</th> </tr> </thead> <tbody> <tr> <td>0B1219A1</td> <td>MM DOUBLE GLASS DOOR INT UPPER BEAM 860</td> <td>1.000</td> <td>PC</td> </tr> <tr> <td>CE1052A1</td> <td>MM USB-CONTRO L PANEL CONNECTING CABLE</td> <td>1.000</td> <td>PC</td> </tr> <tr> <td>CE1053B0</td> <td>MM MICROFIT LED BAR POWER SUPPLY CABL</td> <td>1.000</td> <td>PC</td> </tr> <tr> <td>CE1285A0</td> <td>EMI ROUND FERRITE MOD.26438015 02</td> <td>1.000</td> <td>PC</td> </tr> <tr> <td>CE1290A0</td> <td>EXTRACTABL E FEMALE TERMINAL CPF 5/4</td> <td>1.000</td> <td>PC</td> </tr> <tr> <td>CE1310A1</td> <td>POWER - CONTROL BOARD CONNECTING CABLE</td> <td>1.000</td> <td>PC</td> </tr> <tr> <td>LP1019A0</td> <td>6 SERIES L200 LED LIGHT BAR - E415</td> <td>1.000</td> <td>PC</td> </tr> <tr> <td>LP1025A0</td> <td>L=415 LED LIGHT BAR COVER</td> <td>1.000</td> <td>PC</td> </tr> <tr> <td>MG1083A2</td> <td>MM COMPLETE HANDLE</td> <td>1.000</td> <td>PC</td> </tr> <tr> <td>SL1170A1</td> <td>S57 BLACK SILICON - 310ml CARTRIDGE</td> <td>30.000</td> <td>ML</td> </tr> <tr> <td>VE1030A1</td> <td>MAGNET FOR DOOR MICROSWITC H D=22,9mm</td> <td>1.000</td> <td>PC</td> </tr> <tr> <td>VI1147A0</td> <td>5X25 STAINLESS STEEL SCREW</td> <td>16.000</td> <td>PC</td> </tr> <tr> <td>VI1220A1</td> <td>4,2x12 TCB SELF-TAPPIN G SCREW</td> <td>25.000</td> <td>PC</td> </tr> <tr> <td>VI1996A0</td> <td>M5x35 SCREW</td> <td>13.000</td> <td>PC</td> </tr> <tr> <td>VM1630A1</td> <td>INTERNAL GLASS PUSHING CAP</td> <td>3.000</td> <td>PC</td> </tr> </tbody> </table>	Code	Description	Qty	UOM	0B1219A1	MM DOUBLE GLASS DOOR INT UPPER BEAM 860	1.000	PC	CE1052A1	MM USB-CONTRO L PANEL CONNECTING CABLE	1.000	PC	CE1053B0	MM MICROFIT LED BAR POWER SUPPLY CABL	1.000	PC	CE1285A0	EMI ROUND FERRITE MOD.26438015 02	1.000	PC	CE1290A0	EXTRACTABL E FEMALE TERMINAL CPF 5/4	1.000	PC	CE1310A1	POWER - CONTROL BOARD CONNECTING CABLE	1.000	PC	LP1019A0	6 SERIES L200 LED LIGHT BAR - E415	1.000	PC	LP1025A0	L=415 LED LIGHT BAR COVER	1.000	PC	MG1083A2	MM COMPLETE HANDLE	1.000	PC	SL1170A1	S57 BLACK SILICON - 310ml CARTRIDGE	30.000	ML	VE1030A1	MAGNET FOR DOOR MICROSWITC H D=22,9mm	1.000	PC	VI1147A0	5X25 STAINLESS STEEL SCREW	16.000	PC	VI1220A1	4,2x12 TCB SELF-TAPPIN G SCREW	25.000	PC	VI1996A0	M5x35 SCREW	13.000	PC	VM1630A1	INTERNAL GLASS PUSHING CAP	3.000	PC
Code	Description	Qty	UOM																																																																		
0B1219A1	MM DOUBLE GLASS DOOR INT UPPER BEAM 860	1.000	PC																																																																		
CE1052A1	MM USB-CONTRO L PANEL CONNECTING CABLE	1.000	PC																																																																		
CE1053B0	MM MICROFIT LED BAR POWER SUPPLY CABL	1.000	PC																																																																		
CE1285A0	EMI ROUND FERRITE MOD.26438015 02	1.000	PC																																																																		
CE1290A0	EXTRACTABL E FEMALE TERMINAL CPF 5/4	1.000	PC																																																																		
CE1310A1	POWER - CONTROL BOARD CONNECTING CABLE	1.000	PC																																																																		
LP1019A0	6 SERIES L200 LED LIGHT BAR - E415	1.000	PC																																																																		
LP1025A0	L=415 LED LIGHT BAR COVER	1.000	PC																																																																		
MG1083A2	MM COMPLETE HANDLE	1.000	PC																																																																		
SL1170A1	S57 BLACK SILICON - 310ml CARTRIDGE	30.000	ML																																																																		
VE1030A1	MAGNET FOR DOOR MICROSWITC H D=22,9mm	1.000	PC																																																																		
VI1147A0	5X25 STAINLESS STEEL SCREW	16.000	PC																																																																		
VI1220A1	4,2x12 TCB SELF-TAPPIN G SCREW	25.000	PC																																																																		
VI1996A0	M5x35 SCREW	13.000	PC																																																																		
VM1630A1	INTERNAL GLASS PUSHING CAP	3.000	PC																																																																		



COMPONENT			SPARE PART																																																																											
Code	Description	Image	Code	Description	Kit components																																																																									
VT1290A	EXTERNAL GLASS XEBC-04EU-E		KDR1269A	BT-04 EXTERNAL RIGHT DOOR	<table border="1"> <thead> <tr> <th>Code</th> <th>Description</th> <th>Qty</th> <th>UOM</th> </tr> </thead> <tbody> <tr> <td>VM1631A0</td> <td>PLUS INNER GLASS PUSHING CAP</td> <td>2.000</td> <td>PC</td> </tr> <tr> <td>VM2259A1</td> <td>6 SERIES DOOR LOWER LEFT CAP</td> <td>1.000</td> <td>PC</td> </tr> <tr> <td>VM2260A1</td> <td>6 SERIES DOOR UPPER LEFT CAP</td> <td>1.000</td> <td>PC</td> </tr> <tr> <td>VM2261A1</td> <td>MM DOOR LOWER RIGHT CAP</td> <td>1.000</td> <td>PC</td> </tr> <tr> <td>VM2262A1</td> <td>MM DOOR UPPER RIGHT CAP</td> <td>1.000</td> <td>PC</td> </tr> <tr> <td>VM2267A0</td> <td>INTERNAL GLASS LOCKING SYSTEM SLIDER</td> <td>2.000</td> <td>PC</td> </tr> <tr> <td>VM2268A0</td> <td>DOOR MAGNET COVER</td> <td>2.000</td> <td>PC</td> </tr> <tr> <td>VM2269A0</td> <td>INTERNAL GLASS LOCKING SYSTEM CAP</td> <td>2.000</td> <td>PC</td> </tr> <tr> <td>VM2274A0</td> <td>GROOVED BUSHING</td> <td>1.000</td> <td>PC</td> </tr> <tr> <td>VM2275A0</td> <td>SMOOTH BUSHING</td> <td>1.000</td> <td>PC</td> </tr> <tr> <td>VM2285A0</td> <td>860 SERIES DRIP PROFILE</td> <td>1.000</td> <td>PC</td> </tr> <tr> <td>VM2305A0</td> <td>MM SERIES DOOR CAP FIXING PAWL</td> <td>14.000</td> <td>PC</td> </tr> <tr> <td>VM2312A0</td> <td>MM DRIP PROFILE DRAIN LEFT PIPE</td> <td>1.000</td> <td>PC</td> </tr> <tr> <td>VM2313A0</td> <td>MM DRIP TRAY RIGHT DRAIN PIPE</td> <td>1.000</td> <td>PC</td> </tr> <tr> <td>VM2314A0</td> <td>MM DRIP PROFILE CAP</td> <td>1.000</td> <td>PC</td> </tr> <tr> <td>VM2315A0</td> <td>MIND.Maps INTERNAL GLASS CAP SUPPORT</td> <td>3.000</td> <td>PC</td> </tr> <tr> <td>VM2505A0</td> <td>MM PLUS INTERNAL GLASS SUPPORT</td> <td>2.000</td> <td>PC</td> </tr> </tbody> </table>	Code	Description	Qty	UOM	VM1631A0	PLUS INNER GLASS PUSHING CAP	2.000	PC	VM2259A1	6 SERIES DOOR LOWER LEFT CAP	1.000	PC	VM2260A1	6 SERIES DOOR UPPER LEFT CAP	1.000	PC	VM2261A1	MM DOOR LOWER RIGHT CAP	1.000	PC	VM2262A1	MM DOOR UPPER RIGHT CAP	1.000	PC	VM2267A0	INTERNAL GLASS LOCKING SYSTEM SLIDER	2.000	PC	VM2268A0	DOOR MAGNET COVER	2.000	PC	VM2269A0	INTERNAL GLASS LOCKING SYSTEM CAP	2.000	PC	VM2274A0	GROOVED BUSHING	1.000	PC	VM2275A0	SMOOTH BUSHING	1.000	PC	VM2285A0	860 SERIES DRIP PROFILE	1.000	PC	VM2305A0	MM SERIES DOOR CAP FIXING PAWL	14.000	PC	VM2312A0	MM DRIP PROFILE DRAIN LEFT PIPE	1.000	PC	VM2313A0	MM DRIP TRAY RIGHT DRAIN PIPE	1.000	PC	VM2314A0	MM DRIP PROFILE CAP	1.000	PC	VM2315A0	MIND.Maps INTERNAL GLASS CAP SUPPORT	3.000	PC	VM2505A0	MM PLUS INTERNAL GLASS SUPPORT	2.000	PC	
Code	Description	Qty	UOM																																																																											
VM1631A0	PLUS INNER GLASS PUSHING CAP	2.000	PC																																																																											
VM2259A1	6 SERIES DOOR LOWER LEFT CAP	1.000	PC																																																																											
VM2260A1	6 SERIES DOOR UPPER LEFT CAP	1.000	PC																																																																											
VM2261A1	MM DOOR LOWER RIGHT CAP	1.000	PC																																																																											
VM2262A1	MM DOOR UPPER RIGHT CAP	1.000	PC																																																																											
VM2267A0	INTERNAL GLASS LOCKING SYSTEM SLIDER	2.000	PC																																																																											
VM2268A0	DOOR MAGNET COVER	2.000	PC																																																																											
VM2269A0	INTERNAL GLASS LOCKING SYSTEM CAP	2.000	PC																																																																											
VM2274A0	GROOVED BUSHING	1.000	PC																																																																											
VM2275A0	SMOOTH BUSHING	1.000	PC																																																																											
VM2285A0	860 SERIES DRIP PROFILE	1.000	PC																																																																											
VM2305A0	MM SERIES DOOR CAP FIXING PAWL	14.000	PC																																																																											
VM2312A0	MM DRIP PROFILE DRAIN LEFT PIPE	1.000	PC																																																																											
VM2313A0	MM DRIP TRAY RIGHT DRAIN PIPE	1.000	PC																																																																											
VM2314A0	MM DRIP PROFILE CAP	1.000	PC																																																																											
VM2315A0	MIND.Maps INTERNAL GLASS CAP SUPPORT	3.000	PC																																																																											
VM2505A0	MM PLUS INTERNAL GLASS SUPPORT	2.000	PC																																																																											



COMPONENT			SPARE PART																		
Code	Description	Image	Code	Description	Kit components																
VT1290A	EXTERNAL GLASS XEBC-04EU-E		KDR1269A	BT-04 EXTERNAL RIGHT DOOR	<table border="1"> <thead> <tr> <th>Code</th> <th>Description</th> <th>Qty</th> <th>UOM</th> </tr> </thead> <tbody> <tr> <td>VM2518A0</td> <td>BOARD COOLING FAN SUPPORT</td> <td>1.000</td> <td>PC</td> </tr> <tr> <td>VN1179A1</td> <td>CONTROL BOARD 40x40x20mm 12V COOLING FAN</td> <td>1.000</td> <td>PC</td> </tr> <tr> <td>VT1290A0</td> <td>EXTERNAL GLASS XEBC-04EU-E</td> <td>1.000</td> <td>PC</td> </tr> </tbody> </table>	Code	Description	Qty	UOM	VM2518A0	BOARD COOLING FAN SUPPORT	1.000	PC	VN1179A1	CONTROL BOARD 40x40x20mm 12V COOLING FAN	1.000	PC	VT1290A0	EXTERNAL GLASS XEBC-04EU-E	1.000	PC
Code	Description	Qty	UOM																		
VM2518A0	BOARD COOLING FAN SUPPORT	1.000	PC																		
VN1179A1	CONTROL BOARD 40x40x20mm 12V COOLING FAN	1.000	PC																		
VT1290A0	EXTERNAL GLASS XEBC-04EU-E	1.000	PC																		

ASM3334A/0.D02 - Electrical system - FRONT



ASM3334A/0.D02 - Electrical system - REAR

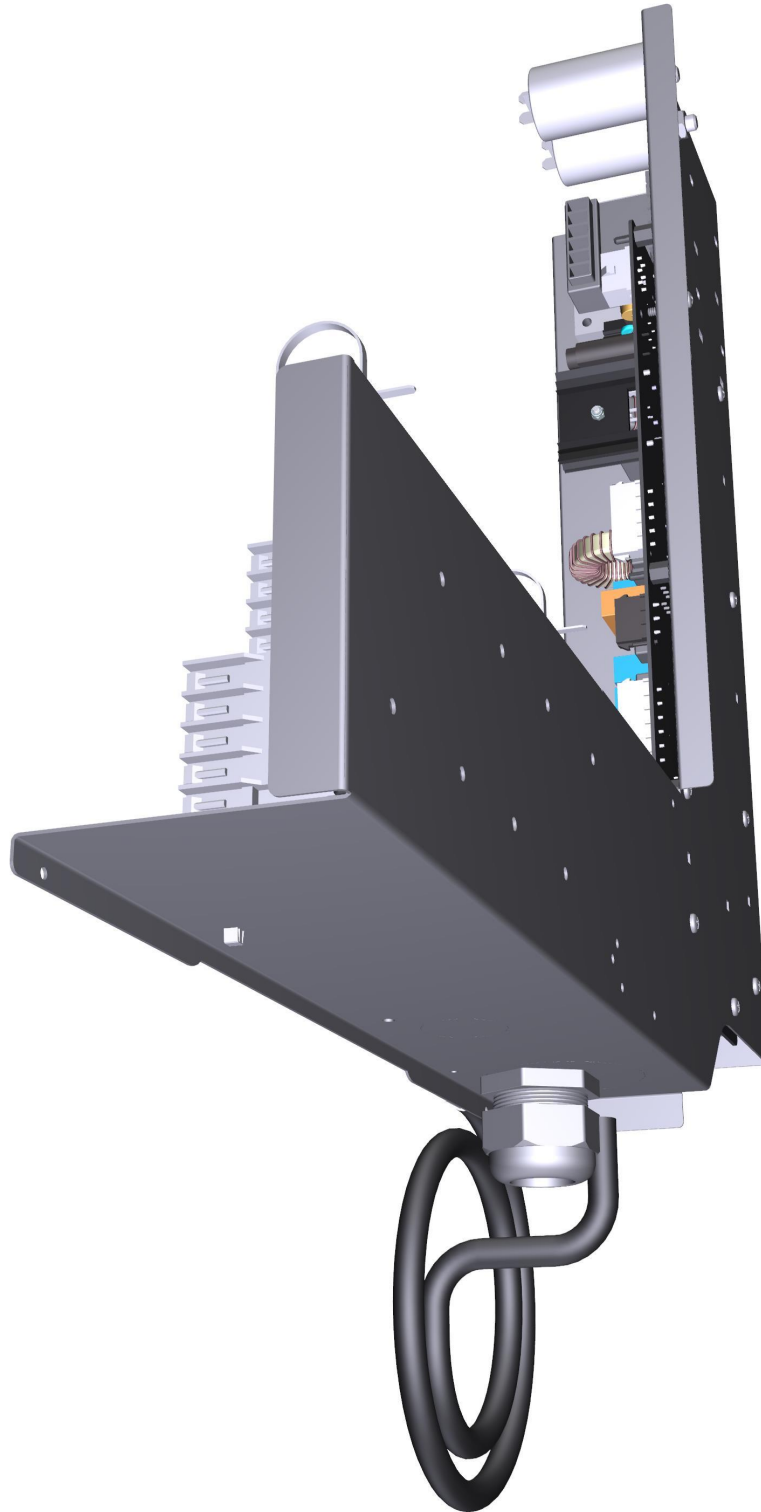



COMPONENT			SPARE PART														
Code	Description	Image	Code	Description	Kit components												
0H7491A	XEBC-04 MM COMPONENTS HOLDING PLATE		0H7491A0	XEBC-04 MM COMPONENTS HOLDING PLATE													
VE1115A	20 A 230V 4 POLES MINICONTRACTOR		KVE1115A	20A 230V 4 POLES MINICONTRACTOR KI	<table border="1"> <thead> <tr> <th>Code</th> <th>Description</th> <th>Qty</th> <th>UOM</th> </tr> </thead> <tbody> <tr> <td>VE1115A0</td> <td>20 A 230V 4 POLES MINICONTRACTOR</td> <td>1.000</td> <td>PC</td> </tr> <tr> <td>VM1075A1</td> <td>PLASTIC CLIP TO FIX CONTACTORS</td> <td>4.000</td> <td>PC</td> </tr> </tbody> </table>	Code	Description	Qty	UOM	VE1115A0	20 A 230V 4 POLES MINICONTRACTOR	1.000	PC	VM1075A1	PLASTIC CLIP TO FIX CONTACTORS	4.000	PC
Code	Description	Qty	UOM														
VE1115A0	20 A 230V 4 POLES MINICONTRACTOR	1.000	PC														
VM1075A1	PLASTIC CLIP TO FIX CONTACTORS	4.000	PC														
VM1056A	SMALL CONTACTOR BRACKET VE1115A		VM1056A0	SMALL CONTACTOR BRACKET VE1115A													
VE1644A	PG 29 STRAIN RELIEF NUT		KVE1645A	REDUCED PG 29 STRAIN RELIEF + NUT KIT	<table border="1"> <thead> <tr> <th>Code</th> <th>Description</th> <th>Qty</th> <th>UOM</th> </tr> </thead> <tbody> <tr> <td>VE1644A0</td> <td>PG 29 STRAIN RELIEF NUT</td> <td>1.000</td> <td>PC</td> </tr> <tr> <td>VE1645A1</td> <td>REDUCED PG 29 STRAIN RELIEF</td> <td>1.000</td> <td>PC</td> </tr> </tbody> </table>	Code	Description	Qty	UOM	VE1644A0	PG 29 STRAIN RELIEF NUT	1.000	PC	VE1645A1	REDUCED PG 29 STRAIN RELIEF	1.000	PC
Code	Description	Qty	UOM														
VE1644A0	PG 29 STRAIN RELIEF NUT	1.000	PC														
VE1645A1	REDUCED PG 29 STRAIN RELIEF	1.000	PC														
VE1645A	REDUCED PG 29 STRAIN RELIEF		KVE1645A	REDUCED PG 29 STRAIN RELIEF + NUT KIT	<table border="1"> <thead> <tr> <th>Code</th> <th>Description</th> <th>Qty</th> <th>UOM</th> </tr> </thead> <tbody> <tr> <td>VE1644A0</td> <td>PG 29 STRAIN RELIEF NUT</td> <td>1.000</td> <td>PC</td> </tr> <tr> <td>VE1645A1</td> <td>REDUCED PG 29 STRAIN RELIEF</td> <td>1.000</td> <td>PC</td> </tr> </tbody> </table>	Code	Description	Qty	UOM	VE1644A0	PG 29 STRAIN RELIEF NUT	1.000	PC	VE1645A1	REDUCED PG 29 STRAIN RELIEF	1.000	PC
Code	Description	Qty	UOM														
VE1644A0	PG 29 STRAIN RELIEF NUT	1.000	PC														
VE1645A1	REDUCED PG 29 STRAIN RELIEF	1.000	PC														

COMPONENT			SPARE PART																		
Code	Description	Image	Code	Description	Kit components																
PE2038A	MIND.Maps PLUS POWER BOARD		KPE2038A	MIND.MAPS PLUS POWER BOARD KIT	<table border="1"> <thead> <tr> <th>Code</th> <th>Description</th> <th>Qty</th> <th>UOM</th> </tr> </thead> <tbody> <tr> <td>PE2038A0</td> <td>MIND.Maps PLUS POWER BOARD</td> <td>1.000</td> <td>PC</td> </tr> <tr> <td>VI1850A0</td> <td>TCB M4x6 SCREW</td> <td>12.000</td> <td>PC</td> </tr> <tr> <td>VM1745A0</td> <td>CARD SUPPORT</td> <td>12.000</td> <td>PC</td> </tr> </tbody> </table>	Code	Description	Qty	UOM	PE2038A0	MIND.Maps PLUS POWER BOARD	1.000	PC	VI1850A0	TCB M4x6 SCREW	12.000	PC	VM1745A0	CARD SUPPORT	12.000	PC
Code	Description	Qty	UOM																		
PE2038A0	MIND.Maps PLUS POWER BOARD	1.000	PC																		
VI1850A0	TCB M4x6 SCREW	12.000	PC																		
VM1745A0	CARD SUPPORT	12.000	PC																		
VM1745A	CARD SUPPORT		KVM1745A	BOARD SUPPORT 10 PCS KIT	<table border="1"> <thead> <tr> <th>Code</th> <th>Description</th> <th>Qty</th> <th>UOM</th> </tr> </thead> <tbody> <tr> <td>VM1745A0</td> <td>CARD SUPPORT</td> <td>10.000</td> <td>PC</td> </tr> </tbody> </table>	Code	Description	Qty	UOM	VM1745A0	CARD SUPPORT	10.000	PC								
Code	Description	Qty	UOM																		
VM1745A0	CARD SUPPORT	10.000	PC																		
CE1355A	CABLE 5 X 2,5 MMQ H07RNF L = 1,5 MT		KCE1355A	L=1.5M 5x2.5mmq POWER CABLE KIT	<table border="1"> <thead> <tr> <th>Code</th> <th>Description</th> <th>Qty</th> <th>UOM</th> </tr> </thead> <tbody> <tr> <td>CE1355A1</td> <td>CABLE 5 X 2,5 MMQ H07RNF L = 1,5 MT</td> <td>1.000</td> <td>PC</td> </tr> </tbody> </table>	Code	Description	Qty	UOM	CE1355A1	CABLE 5 X 2,5 MMQ H07RNF L = 1,5 MT	1.000	PC								
Code	Description	Qty	UOM																		
CE1355A1	CABLE 5 X 2,5 MMQ H07RNF L = 1,5 MT	1.000	PC																		
CN1003A	6,3 Uf MOTOR CAPACITOR		KCN1003A	6,3 uF MOTOR CAPACITOR KIT	<table border="1"> <thead> <tr> <th>Code</th> <th>Description</th> <th>Qty</th> <th>UOM</th> </tr> </thead> <tbody> <tr> <td>CN1003A0</td> <td>6,3 Uf MOTOR CAPACITOR</td> <td>1.000</td> <td>PC</td> </tr> <tr> <td>VI1931A0</td> <td>M8x1.65 H4 CH13 ZINC PLATED NUT</td> <td>1.000</td> <td>PC</td> </tr> <tr> <td>VI1932A0</td> <td>D8 INDENTED ZINC PLATED WASHER</td> <td>1.000</td> <td>PC</td> </tr> </tbody> </table>	Code	Description	Qty	UOM	CN1003A0	6,3 Uf MOTOR CAPACITOR	1.000	PC	VI1931A0	M8x1.65 H4 CH13 ZINC PLATED NUT	1.000	PC	VI1932A0	D8 INDENTED ZINC PLATED WASHER	1.000	PC
Code	Description	Qty	UOM																		
CN1003A0	6,3 Uf MOTOR CAPACITOR	1.000	PC																		
VI1931A0	M8x1.65 H4 CH13 ZINC PLATED NUT	1.000	PC																		
VI1932A0	D8 INDENTED ZINC PLATED WASHER	1.000	PC																		
MR1004A	41A 450V 7 POLES TERMINAL		KMR1004A	7FTW 1+2+3/4+5+6 TERMINAL BLOCK KIT	<table border="1"> <thead> <tr> <th>Code</th> <th>Description</th> <th>Qty</th> <th>UOM</th> </tr> </thead> <tbody> <tr> <td>MR1004A1</td> <td>41A 450V 7 POLES TERMINAL</td> <td>1.000</td> <td>PC</td> </tr> </tbody> </table>	Code	Description	Qty	UOM	MR1004A1	41A 450V 7 POLES TERMINAL	1.000	PC								
Code	Description	Qty	UOM																		
MR1004A1	41A 450V 7 POLES TERMINAL	1.000	PC																		



COMPONENT			SPARE PART														
Code	Description	Image	Code	Description	Kit components												
VE1026A	230-21-12Vac 80VA TRANSFORMER		KVE1026A	230-21-12vac 90VA TRANSFORMER KIT	<table border="1"> <thead> <tr> <th>Code</th> <th>Description</th> <th>Qty</th> <th>UOM</th> </tr> </thead> <tbody> <tr> <td>VE1026A0</td> <td>230-21-12Vac 80VA TRANSFORME</td> <td>1.000</td> <td>PC</td> </tr> <tr> <td>VI1950A0</td> <td>ST. STEEL 4,2X13 TCB SELF-DRILLIN G SCREW</td> <td>4.000</td> <td>PC</td> </tr> </tbody> </table>	Code	Description	Qty	UOM	VE1026A0	230-21-12Vac 80VA TRANSFORME	1.000	PC	VI1950A0	ST. STEEL 4,2X13 TCB SELF-DRILLIN G SCREW	4.000	PC
Code	Description	Qty	UOM														
VE1026A0	230-21-12Vac 80VA TRANSFORME	1.000	PC														
VI1950A0	ST. STEEL 4,2X13 TCB SELF-DRILLIN G SCREW	4.000	PC														